

# **EASY MRV Connection Kit**

## **Operation & Installation Manual**

**MS1-036A**

**MS1-060A**

**MS3-036A**

No. 0150515415

- Please read this manual carefully before using
- Keep this operation manual for future reference

# User Manual

---

## CONTENT

Parts and Functions.....	1
Safety .....	2
Installation instruction .....	4
Installation procedure .....	6
Electrical wiring.....	15
Initial setting.....	19
Commissioning .....	22

# Parts and Functions

MS1-036A

Indoor unit side (2 pipes)

Outdoor unit side (2 pipes)

Liquid Pipe (Ø9.52)

Gas Pipe (Ø15.88)

Liquid Pipe (Ø9.52)

Gas Pipe (Ø15.88)

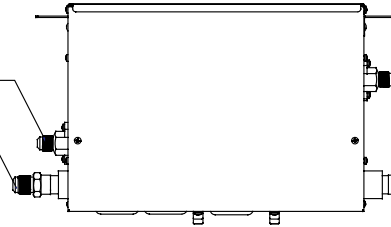

MS1-060A

Indoor unit side (2 pipes)

Outdoor unit side (2 pipes)

Liquid Pipe (Ø9.52)

Gas Pipe (Ø19.05)

Liquid Pipe (Ø9.52)

Gas Pipe (Ø19.05)

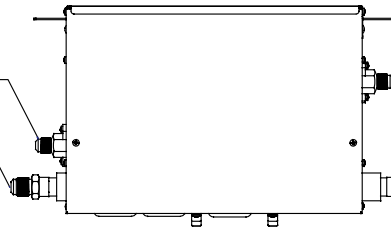

MS3-036A

Indoor unit side (2 pipes)

Outdoor unit side (2 pipes)

Liquid Pipe (Ø6.35)

Gas Pipe (Ø15.88)

Liquid Pipe (Ø9.52)

Gas Pipe (Ø19.05)

Drainage Pipe  
(Outer Diameter) (Ø25)

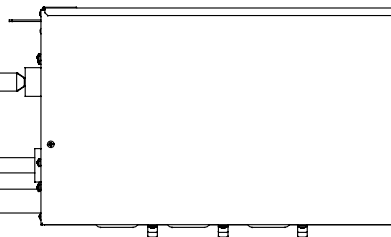

# Safety

---

- If the connection kit is transferred to a new user, this manual shall be transferred to the user, together with the conditioner.
- Before installation, be sure to read Safety Considerations in this manual for proper installation.
- The safety considerations stated below is divided into “⚠Warning” and “⚠Attention”. The matters on severe accidents caused from wrong installation, which is likely to lead to death or serious injury, are listed in “⚠Warning”. However, the matters listed in “⚠Attention” are also likely causing the severe accidents. In general, both of them are the important items related to the security, which should be strictly abided by.
- After the installation, perform test run to make sure everything is in normal conditions, and then operate and maintain the connection kit in accordance with the user manual. The user manual should be delivered to the user for proper keeping.

## ⚠Warning

- Please ask the special maintenance station for installation and repair. Water leakage, electric shocks or fire accidents might be caused from improper installation if you conduct the installation by your own.
- The installation should be conducted properly according to this manual. Water leakage, electric shocks or fire accidents might be caused from improper installation.
- Please make sure to install the connection kit on the place where can bear the weight of the connection kit. The connection kit can't be installed on the grids such as the non-special metal burglar-proof net. The place with insufficient support strength might cause the dropdown of the machine, which may lead to personal injuries.
- The installation should be ensured against typhoons and earthquakes, etc. The installation unconformable to the requirements will lead to accidents due to the turnover of the machine.
- Specific cables should be used for reliable connections of the wirings. Please fix the terminal connections reliably to avoid the outside force applied on the cables from being impressed on the cables. Improper connections and fixings might lead to such accidents as heating or fire accidents.
- Correct shapes of wirings should be kept while the embossed shape is not allowed. The wirings should be reliably connected to avoid the cover and the plate of the electrical cabinet clipping the wiring. Improper installation might cause such accidents as heating or fire accidents.
- While placing or reinstalling the connection kit, except the specific refrigerant (R410A), don't let the air go into the refrigeration cycle system. The air in the refrigeration cycle system might lead to the cracking or personal injuries due to abnormal high pressure of the refrigeration cycle system.
- During installation, please use the accompanied spare parts or specific parts. If not, water leakage, electric shocks, fire accidents or refrigerant leakage might be caused.
- During installation, if refrigerant leakage occurs, ventilation measures should be taken, for the refrigerant gas might generate harmful gases upon contacting the flame.

# Safety

---

- After installation, check if any refrigerant leakage exists. If the refrigerant gas leaks in the room, such things as air blowing heaters and stoves, etc. may generate harmful gases.
- Don't install the connection kit at the places where the flammable gases may leak. In case the gas leakage occurs around the machine, such accidents as fire disasters may be caused.
- The refrigerant gas pipe, HP gas pipe and liquid pipe should be heat insulated to preserve heat. For inappropriate heat insulation, the water caused from the condensation will drop to get the article at home wet.
- The electrical construction shall be implemented by the correspondingly qualified personnel in accordance with electrical construction standards, local electrical laws as well as specifications. Moreover, dedicated circuit must be used, rather than the wire pin. Insufficient capacity of the wire circuit and unprepared construction (if any) may cause electric shock, fires, etc.
- During the process of grounding, the ground wire cannot be connected to the gas pipe, water pipe, lightning rod or ground wire of the telephone. Incomplete grounding may cause electric shock, fires, etc.
- Install residual-current circuit breaker, or electric shock, fires, etc. will occur.
- When contacting electrical components, ensure they are powered off. Contacting the live part may result in the danger of electric shock.
- If there is leakage of the refrigerant gas flow during operation, refrigerant gas is required. If the refrigerant gas contacts any fire, poisonous gases will be produced.
- If the supply cord is damaged, it must be replaced by the manufacturer, its service agent or similarly qualified persons in order to avoid a hazard.
- This appliance is not intended for use by persons (including children) with reduced physical, sensory or mental capabilities, or lack of experience and knowledge, unless they have been given supervision or instruction concerning use of the appliance by a person responsible for their safety.
- Children should be supervised to ensure that they do not play with the appliance.
- This appliance can be used by children aged from 8 years and above and persons with reduced physical, sensory or mental capabilities or lack of experience and knowledge if they have been given supervision or instruction concerning use of the appliance in a safe way and understand the hazards involved. Children shall not play with the appliance. Cleaning and user maintenance shall not be made by children without supervision.
- The appliances are not intended to be operated by means of an external timer or separate remote-control system.
- Keep the appliance and its cord out of reach of children less than 8 years.

# Safety

---

## Attention

- The connection kit should be effectively grounded. Electric shocks may occur if the connection kit is ungrounded or inappropriately grounded. The wire for earthing shouldn't be connected to the connections on the gas pipe, water pipe, lightning rod or telephone.
- The breaker for electricity leakage should be mounted. If not, accidents such as electric shocks may happen.
- The installed connection kit should be checked for electricity leakage by being powered.
- After installation, all cassette concealed connection kits should be trial-tested. After the proper operation of the machine, other fitments can be made.
- When installing the connection kit, please fix the box and connecting pipes in an efficient way to avoid shaking when changing connection kit.
- If the ambient humidity is over 80%, when the water discharge hole is blocked or the filter becomes dirty, or airflow speed change, there may be leads to condensing water drop down, and at the same time there may be some drops of water spit out.
- Keep the connection kit, power supply wiring, conductor, etc. at least 1 m away from the TV and radio to avoid image interference and noise. However, sometimes there is still noise when the distance is over 1 m due to the different states of radio waves.
- Try to install connection kit where the fluorescent lamp is far away.
- When wireless devices are being installed, the distance that the signal from the controller will reach may be shortened in a room with a fluorescent lamp that is turned on in an electric way (frequency conversion or rapid start).

## Prohibitions

- Do not use components other than the fuse of proper capacity, such as metal wire and copper wire, which will cause fires and other faults if used instead of the fuse.
- When doing the cleaning and maintenance, make sure that the operation has been stopped and the manual power switch is in the off position.
- Do not use appliances such as water heater near the connection kit. Using appliances producing steam near the connection kit may lead to accidents such as water leakage, electric leakage and short circuit when the cooling system is in operation.

# Installation instruction

## Do not install at such places

1. A place that is filled with mineral oil, a kitchen which has oil and steam everywhere, etc., which may cause degradation, falling off and water leakage of the resinous components.
2. A place with corrosive gases such as sulphurous acid gas, which will lead to the corrosion of the copper tube, welding joint, etc., causing refrigerant leakage.
3. A place where machines give out electromagnetic waves, which will lead to abnormality and improper function of the control system.
4. A place with possible leakage of combustible gases, floating of carbon fiber and combustible dust and use of volatile combustible substances such as diluents, the accumulation of which around the machine set will lead to fires.
5. A place where small animals inhabit, whose contacting the inner electrical components may cause faults, smoking, outbreak of a fire, etc.
6. A coastal place with high salinity and a place with great variation in voltage such as a factory, which may cause faults to vehicles and ships.







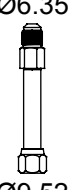
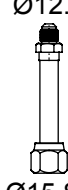
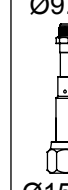
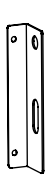
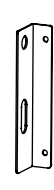
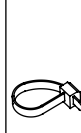

## Attention item

Install after making sure that the type of the refrigerant used is R410A. If any other type of refrigerant is used, the machine cannot run.

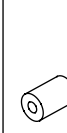
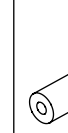



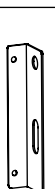
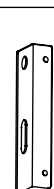

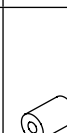
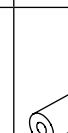
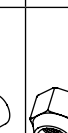

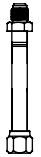

- Before and after the unpacking, if connection kit is to be moved, the hoisting handles (totally 4) shall be held firmly. Do not apply force to other parts, especially a refrigerant tube and an electrical cabinet.
- Concerning the installation of the outdoor and indoor units, refer to the installation specification of each unit.

## Accessories

Confirm that the accessories below are packed together.

MS1-036A	Variable diameter			suspending		clip	screw	Thermal insulation pipe		Nut	Specification
Quantity	2	2	2	1	1	8	4	2	2	6	1
Shape	 Ø6.35 Ø9.52	 Ø12.7 Ø15.88	 Ø9.52 Ø15.88								
MS1-060A	Variable diameter			suspending		clip	screw	Thermal insulation pipe		Nut	Specification
Quantity	2	2		1	1	8	4	2	2	4	1
Shape	 Ø12.7 Ø9.52	 Ø15.88 Ø19.05									

# Installation instruction

MS3-036A	Variable diameter					suspending		clip	screw	Thermal insulation pipe		Nut	Specifi cation
	1	1	3	3	3	1	1	16	4	4	4	7	1
Shape	Ø12.7  Ø9.52	Ø15.88  Ø19.05	Ø9.52  Ø6.35	Ø12.7  Ø15.88	Ø9.52  Ø15.88								

<Entrustment>

Before the installation is completed, do not abandon the accessories needed in installation.

## Combinations

- This connection kit is used for super match indoor unit, unconnected with other indoor unit.
- This connection kit can match with MRV III-S , MRV III-C system.
- Concerning the model of the connectible indoor unit, see the sample brochure, etc. for confirmation.
- According to table 1, you can make sure the quantity and total capacity of indoor unit connection kit.

Table1: Total capacity of connection kit:

Connection kit	Total capacity of indoor unit (kBtu/h)	Quantity of indoor unit
MS1-036A	Less than 36 (10.5kW)	1
MS1-060A	36 ~ 60 (10.5-17.6kW)	1
MS3-036A	Less than 36 (10.5kW)	3

## Inspection item

Pay much attention to the following during installation. Check them again after completion.

(1) Inspection items after installation

Inspection item	Defect	Inspection column
If the installation of connection kit is secure ?	Falling off, vibration and noise	
If gas leakage inspection is completed ?	No heating/cooling	
If complete insulation is achieved (refrigerant piping and tubing connections) ?	Water leakage	
If the voltage of the power supply is consistent with that on the nameplate ?	Out of service, burnt	
If there is improper wiring or piping ?	Out of service, burnt	
If there is construction without grounding ?	Danger in electric leakage	
If the diameter of the wire is as specified ?	Out of service, burnt	

(2) Inspection upon delivery

Inspection item	Inspection column
If the electric box cover is installed	
If the installation specification is transferred to the customer	



# Installation procedure

## 1. Pre-installation

The installation location selected shall meet the following conditions and be approved by users.

- The strength shall be sufficient to withstand the weight of the connection kit
- There is no significant tilt on the plane.
- Ensure that there is enough space for installation and maintenance.
- There is space for inspection on the side and top of the electric box
- The length of piping between the indoor and outdoor units shall be within the permissible range (referring to the specification attached to the outdoor unit).
- Please install the connection kit in places where noise will not influence the customers too much (such as washroom, passageway, warehouse, equipment room, etc.). Places with high requirement for quiet are not suggested for installation, such as bedroom, drawing room, meeting room, office, etc.

Note:

- the electrical box can be changed as show in item 3 connection kit installation.
- A noise may be emitted by the connection kit as a result of control during operation or stopping of an indoor unit. If it is installed in the ceiling where it is exposed, take adequate precautions with the installation location.

<Notice item>

- Inspect whether the installation location can sufficiently withstand the weight of connection kit and set the hoisting bolts by reinforcing the beam if necessary. Use hoisting bolts in installation (referring to 2 for the preparation before installation).
- Install the power wiring and power line of the connection kit at more than 1 m away from TV and radio to prevent the image clutter and noise. But, there may be noise even if it is more than 1 m according to the different waves.

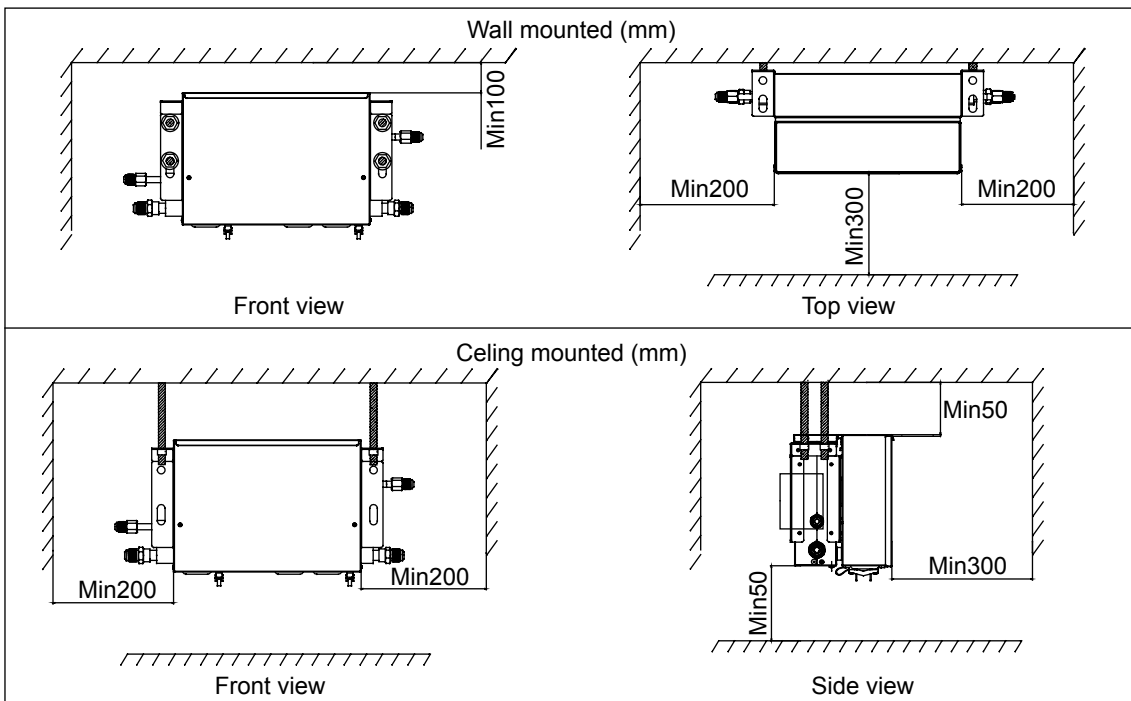

# Installation procedure

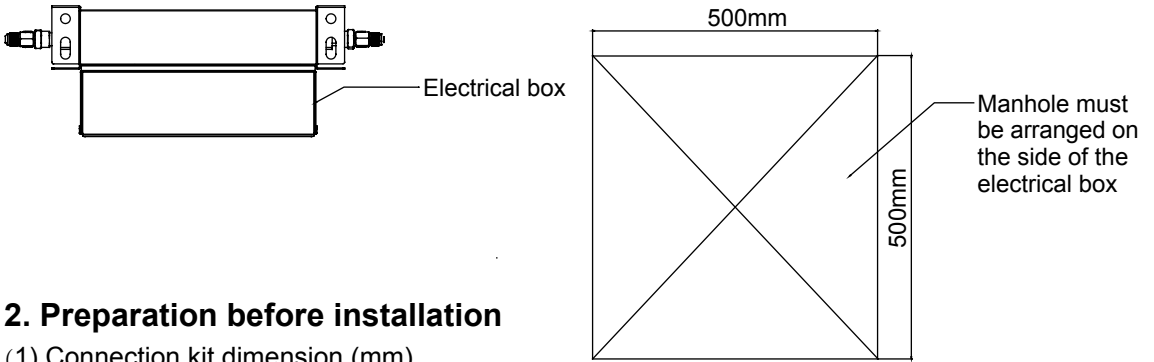

## 2. Preparation before installation

(1) Connection kit dimension (mm)

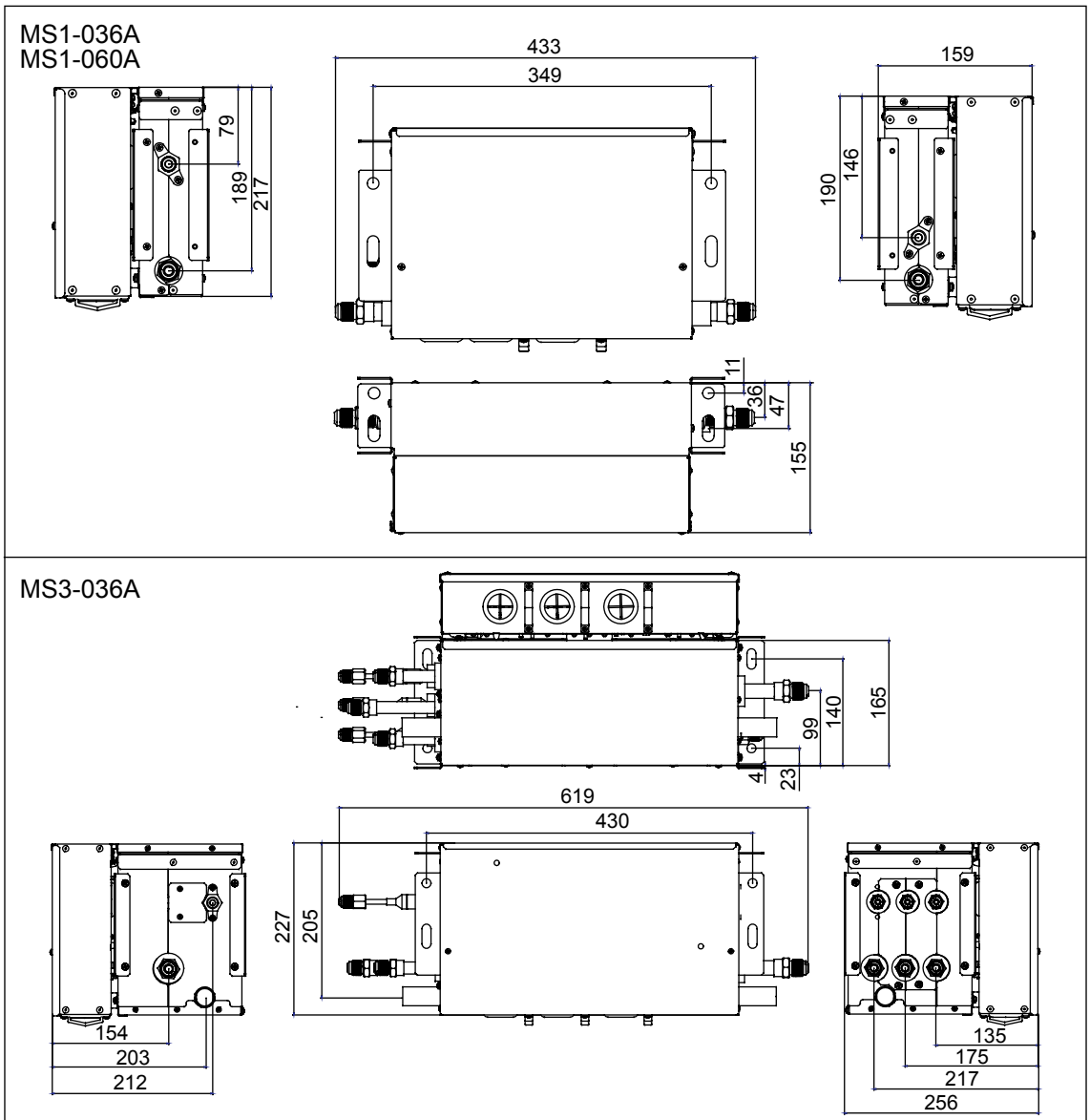

# Installation procedure

## (2) Lifting dimension of connection kit (mm)

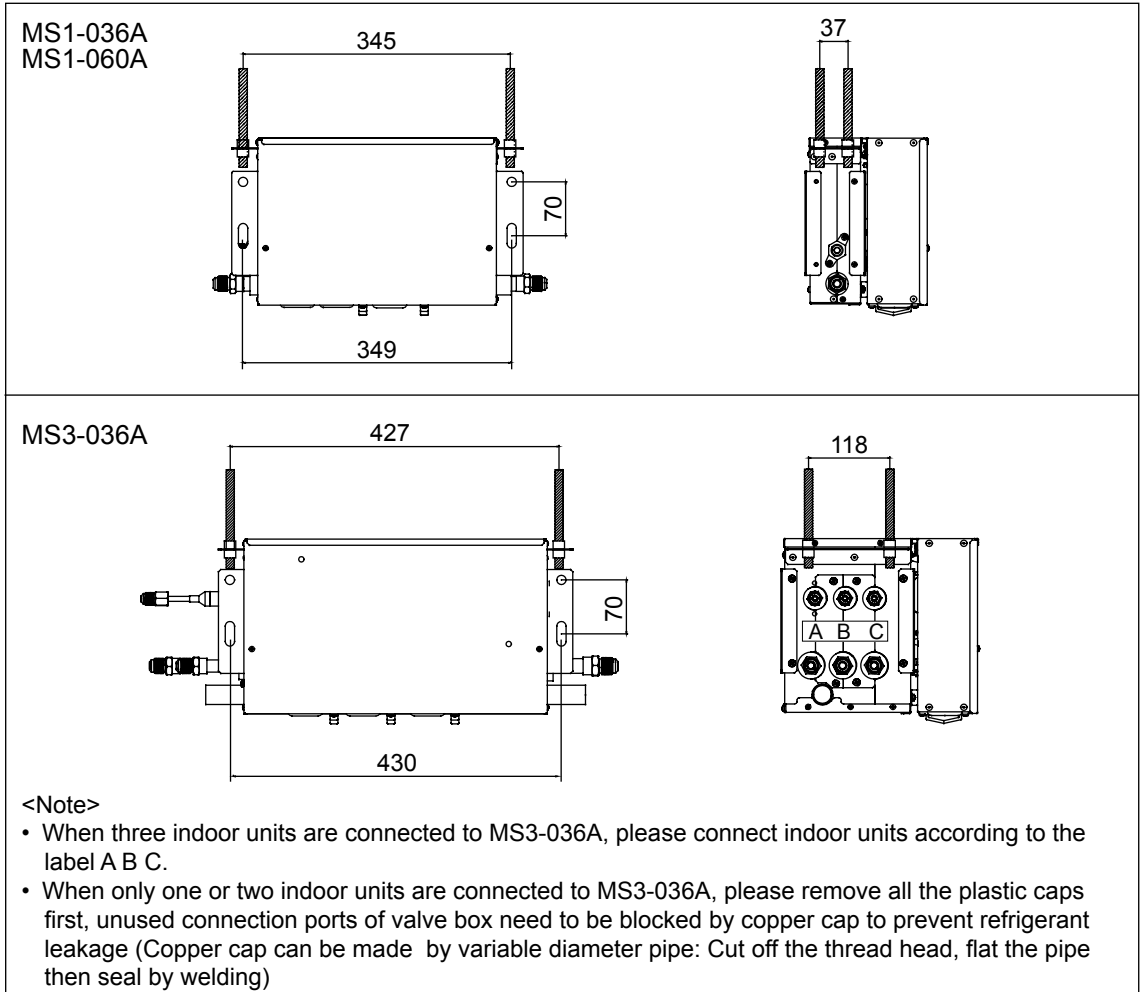
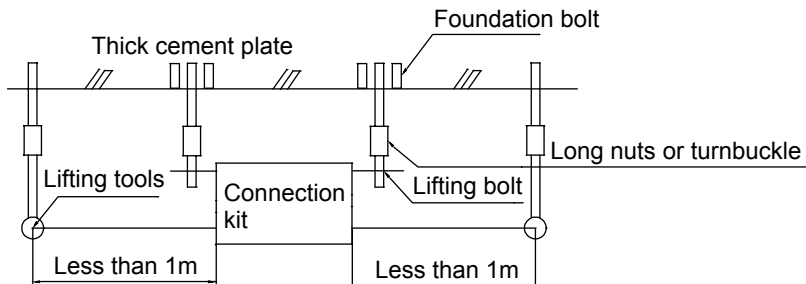

Fig.1



Note: All the parts in the figure are purchased locally.

Fig.2

# Installation procedure

See the Fig.1 & Fig.2 to install the lifting bolts and hoisting tools.

- Use the lifting bolts with the size of M8~M10
- Press insert for new settings. Press hole in anchor if set. Ensure that it can sufficiently withstand the weight of the connection kit before installation.

## 3. Installation of connection kit

Use parts and components specified for installing the installation components.

(1) Change the installation direction of electric box according to requirements following the steps below; (see Fig.1)

- ① Remove the cover of the electrical appliance box; (2 screws)
- ② Remove the top plate; (2 screws)
- ③ Remove the electrical appliance box; (2 screws)
- ④ Change the outgoing direction of wiring (electric valve coil) between the equipment and the electrical appliance box;
- ⑤ Rotate 180° to install the top plate;
- ⑥ Install the electrical appliance box;
- ⑦ Install the cover of the electrical appliance box.

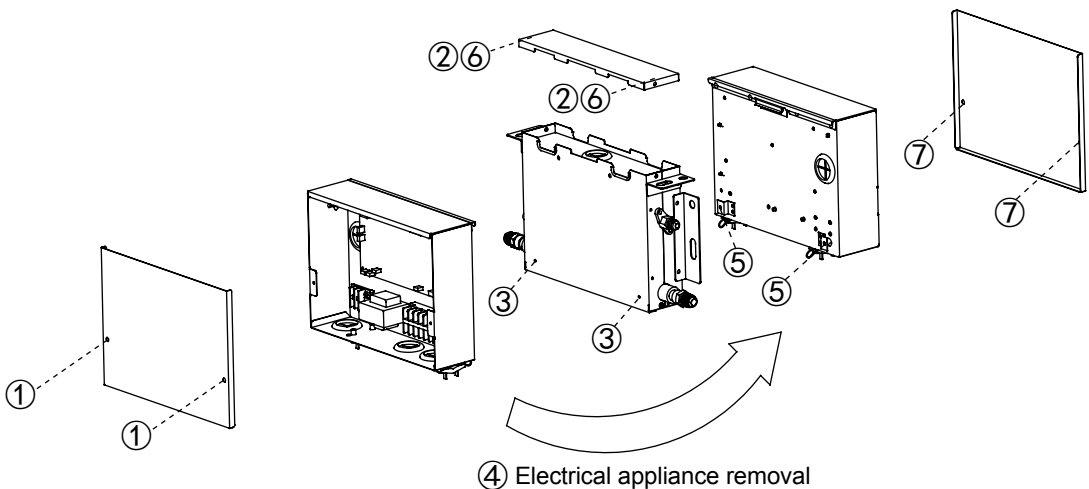

Fig.1

Install the lifting tools on the lifting bolts according to the instruction of the Fig.2

Be sure to follow the stipulations on products locally purchased to use nuts (M8 or M10 of 3 pieces for 4 positions) and gaskets (M8 with the outer diameter of 24~28 mm and M10 with that of 30~34 mm of 2 pieces for 4 positions) on the upper and lower sides of the lifting tools.

<Note>

Be sure that the product must be installed with the top surface (the oblique surface in the Fig.2) upward, or it will not work well and increase the working noise.

# Installation procedure

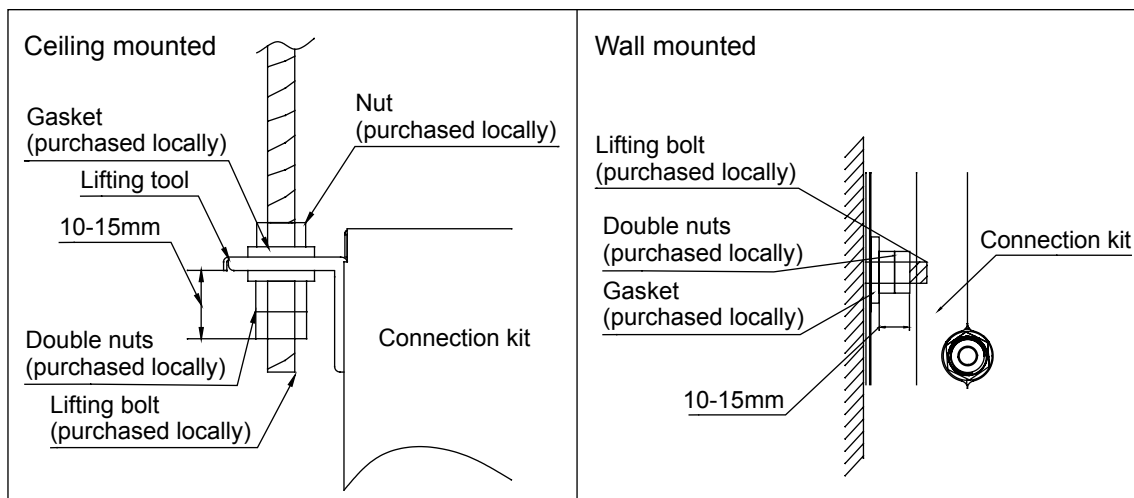

Fig.2

## 4. Refrigerant pipe Installation

- Pipes between the outdoor unit and connection kit, selection of refrigerant branching suite, and the pipe between refrigerant branching suites and the indoor units, please refer to the installation instructions or equipment design data attached to the outdoor unit.
- Before Installation, make sure the type of the refrigerant to be used is R410A. (If a refrigerant other than this type is used, it cannot run properly)
- Please provide thermal insulation at gas pipe, liquid pipe and the connections between these pipes. In the absence of thermal insulation, liquid leakage and scalding may happen. Please provide thermal insulation material that can sustain temperature over 120 °C.
- Enhance the thermal insulation material based on the installation environment. The indicators are shown below.  
For RH75%–80% at 30°C: over 15 mm thick.  
For over 80% at 30°C: over 20 mm thick.  
If not reinforced, the thermal insulation material surface is prone to condensation. Please refer to the equipment design data for further details.

The outdoor unit is already filled with refrigerant.

To connect the pipes to connection kit or remove them from connection kit, do use both spanner and torque wrench.

Apply ester or ether oil to inside and outside of the flare. Screw it for 3 to 4 rounds with hands and then tighten it.

Determine the tightening torque. (Excessive tightening may damage the nuts and hence cause leakage)

Check the connecting pipes for gas leakage and then fix the thermal insulation.

Only use sealing gasket to wrap the part jointing between the gas pipe and thermal insulation.

For pipe cutter and flare tool, please use R410A special tools.

# Installation procedure

## <Notes>

- Please do not let any type of gas other than the specified refrigerant go into the refrigeration system;
- In case of refrigerant leakage during operation, please replace the gas. (Fill the refrigerant at the outdoor unit)

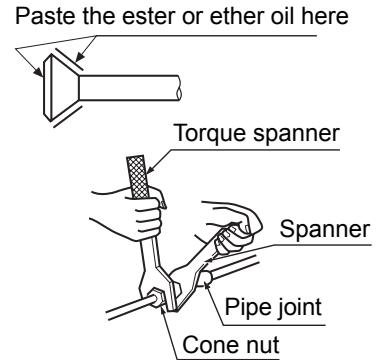

## Select piping material

- Make sure both the internal surface and external surface of the pipes are intact and are free from harmful contaminants such as sulphur, oxide, foreign matter, cutting powder, grease and water.
- Please use the following materials for refrigerant pipe.

Connection kit		MS1-036A	MS1-060A	MS3-036A
Connection kit - Indoor max. single pipe length (m)		15	15	15
Single way total pipe length		refer to outdoor		
Single way pipe length		refer to outdoor		
Main pipe between outdoor to 1st branch		refer to outdoor		
Pipe length between outdoors		refer to outdoor		
Height difference between indoor and outdoor	Outdoor is upper	refer to outdoor		
	Outdoor is lower	refer to outdoor		
Height difference between outdoors (in the same system)		refer to outdoor		
Height difference between indoors		refer to outdoor		

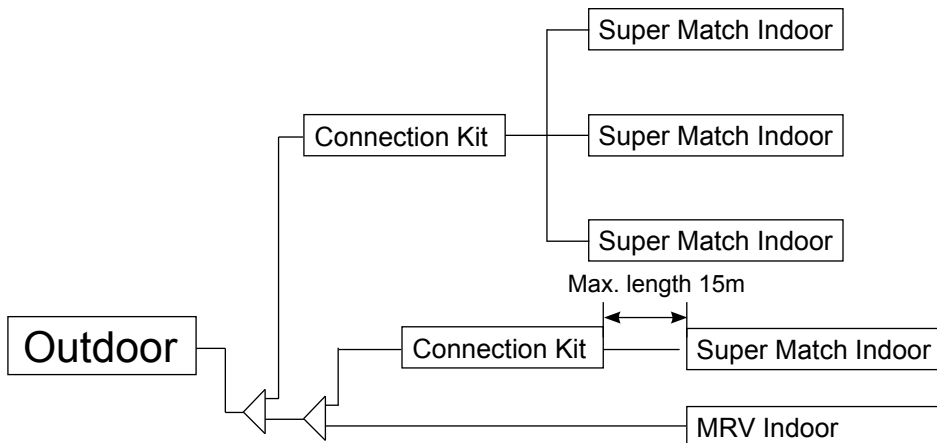

- The branch pipe for the pipe must have refrigerant branching suite. For selection of refrigerant branching suite and max. height drop between indoor units, please refer to the installation instructions or technical data attached to the outdoor unit.

# Installation procedure

## Piping maintenance

During installation, provide maintenance as specified in the table in order to prevent water, foreign matter and dust from entering the pipes.

Location	Work period	Maintenance method
Outdoors	More than 1 month	Screw
	Less than 1 month	Screw or strap
Indoors	—	

### Note

Particularly when a pipe is to penetrate through a wall or extend to outdoors, make sure foreign matter and dust etc cannot enter the pipe.

## Attention item for piping connection

- To connect a pipe to or remove it from the connection kit, do use pliers for screws and torque spanner;
- When installing the connection kit, please fix the box and connecting pipes in an efficient way to avoid shaking when changing connection kit.
- For the sizes of the flares, please refer to <Table-1>.

### <Note>

- For connection at a flare, apply ester or ether oil to the flare (both inner surface and outer surface). Apply such oil for 3 to 4 times and insert the screw in the first use
- The tightening torque for the flare is given in <Table-1>.

If no torque wrench is available, act as the follows.

- ① Use a spanner to tighten the nut of the flare to a position where the tightening torque sharply increases.
- ② The tightening angle for the position where the tightening torque sharply increases <Table -2>.
- ③ After the work, make sure there is no air leakage.

<Table-1>

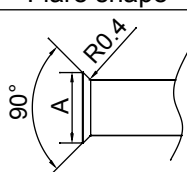
Tube size	Tightening torque (N.m)	Machined flare size A (mm)	Flare shape
Ø6.35	14.2~17.2	8.7~9.1	
Ø9.52	32.7~39.9	12.8~13.2	
Ø12.7	49.5~60.3	16.2~16.6	
Ø15.88	61.8~75.4	19.3~19.7	
Ø19.05	97.2~118.8	23.7—23.9	

<Table-2>

Pipe size	Tightening angle	Recommended tool length (mm)
Ø6.35	60°~90°	150
Ø9.52	60°~90°	200
Ø12.7	30°~60°	250
Ø15.88	30°~60°	300
Ø19.05	20°~35°	450

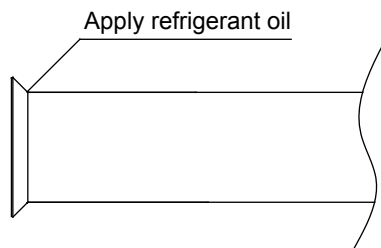

# Installation procedure

## Selection of piping dimensions

Select refrigerant branching dimensions between outdoor units and connection kit, between connection kit and indoor units according to the Operation & Installation Manual of outdoor units and indoor units.

Dimensions (mm) of connection pipe of the valve box

Type of Connection kit	Dimension ( outer diameter )			
	Gas pipe of outdoor units / Conversion specifications	Gas pipe of indoor units / Conversion specifications	Liquid pipe of outdoor units / Conversion specifications	Liquid pipe of indoor units / Conversion specifications
MS1-036A	Ø15.88/Ø12.7/Ø9.52	Ø15.88/Ø12.7/Ø9.52	Ø9.52/Ø6.35	Ø9.52/Ø6.35
MS1-060A	Ø19.05/Ø15.88	Ø19.05/Ø15.88	Ø9.52/Ø12.7	Ø9.52/Ø12.7
MS3-036A	Ø19.05/Ø15.88	Ø15.88/Ø12.7/Ø9.52	Ø9.52/Ø12.7	Ø6.35/Ø9.52

## Pipe connection

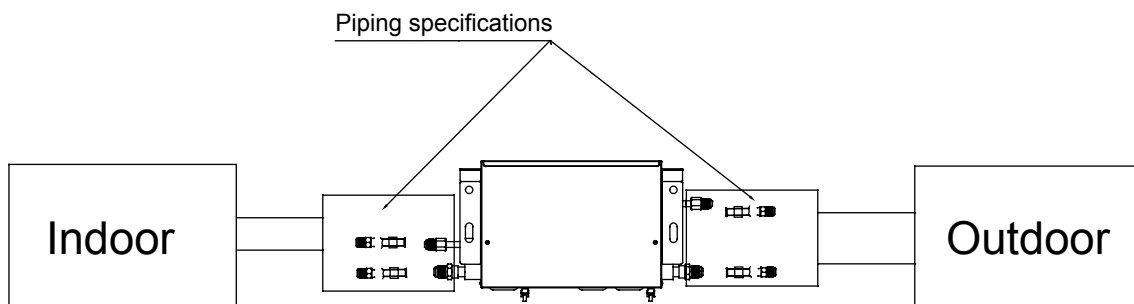

When the connection kit and the piping specifications are not the same, can import and conversion by Variable diameter. (the transfer pipe size selection see accessories)

## Pipe insulation

Please use the auxiliary insulation cylinder and tie wire for insulation works according to Fig.1 after the gas leakage test.

Note 1:

For gas-liquid pipe of connection kit shall be wrapped with insulation materials (purchased locally) when their auxiliary insulation cylinders have been installed.

For installation of insulation materials for the flare nut connections, it shall be cautioned that:

- (1) Please connect it tightly so as to ensure no gas leakage at both ends.
- (2) The retaining clamp shall not be over tight so as to ensure the thickness of the insulation materials.
- (3) Joints of insulation materials (purchased locally) for the upper flare nut connections shall be wrapped upwards.
- (4) Ensure that joints of the insulation materials are installed upwards. (See Fig.2.)



# Installation procedure

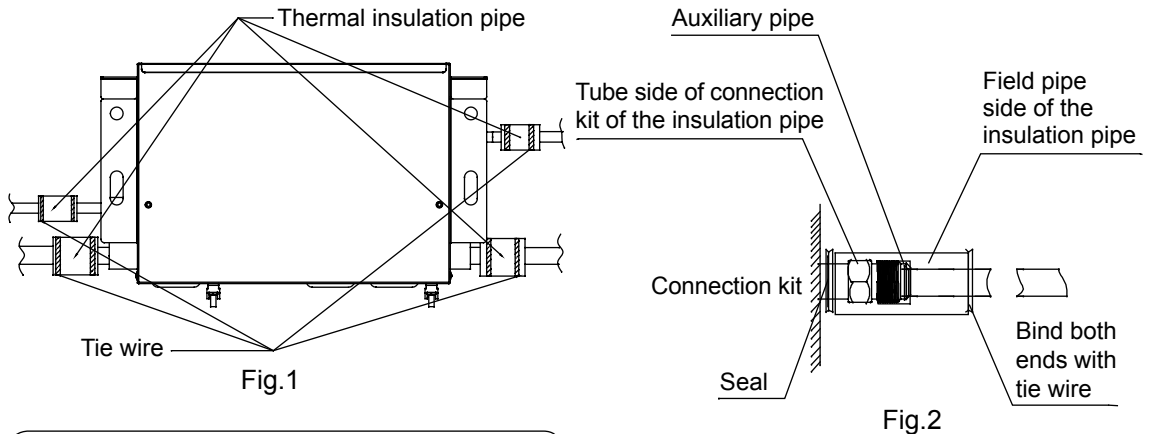

## Installation of drain hose (For MS3-036A)

1. Drain hose must be wrapped up with insulation sleeve and tightened with strap to prevent air leaked in producing condensate.
2. To prevent water flowing back into air conditioner when it stops running, drain hose shall decline to the drainage side with a declination of above 1/100. Drain hose expansion or water accumulation shall be prevented, or else it will cause abnormal noise.
3. When connecting the drain hose, do not pull on it so as to avoid the pipe connections getting loose or off. Drain hose should not be pulled out laterally for more than 20cm and should be supported every 0.8-1.0m to avoid bending.
4. The end of drain hose should be more than 50mm away from the ground or the bottom of drainage tank. It should not be put in water. To directly drain condensate into drainage ditch, the drain hose must be U-shaped to avoid stink spreading through the hose into room.

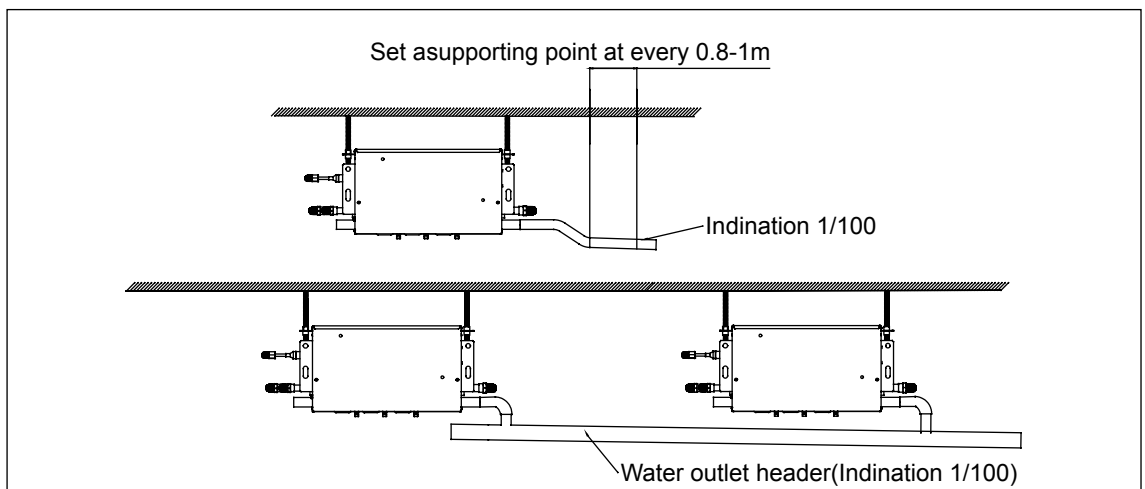

## Additional refrigerant charging

Charge the additional refrigerant of the liquid pipe between outdoor units and connection kits, between connection kits and indoor units according to the Operation & Installation Manual of outdoor unit.

# Electrical wiring

---

## ⚠ Warning

- Electrical construction should be made with specific mains circuit by the qualified personnel according to the installation instruction. Electric shock and fire may be caused if the capacity of power supply is not sufficient.
- During arranging the wiring layout, specified cables should be used as the mains line, which accords with the local regulations on wiring. Connecting and fastening should be performed reliably to avoid the external force of cables from transmitting to the terminals. Improper connection or fastness may lead to burning or fire accidents.
- There must be the ground connection according to the criterion. Unreliable grounding may cause electrical shocks. Do not connect the grounding line to the gas pipe, water pipe, lightning rod and telephone line.

## ⚠ Attention

- Only copper wire can be used. Breaker for electric leakage should be provided, or electric shock may occur.
- The wiring of the mains line is of Y type. The power plug L should be connected to the live wire and plug N connected to null wire while ⊕ should be connected to the ground wire. For the type with auxiliary electrically heating function, the live wire and the null wire should not be misconnected, or the surface of electrical heating body will be electrified. If the power line is damaged, replace it by the professional personnel of the manufacturer or service center.
- The power line of connection kits should be arranged according to the installation instruction of connection kits.
- The electrical wiring should be out of contact with the high-temperature sections of tubing as to avoid melting the insulating layer of cables, which may cause accidents.
- After connected to the terminal tier, the tubing should be curved into be a U-type elbow and fastened with the pressing clip.
- Controller wiring and refrigerant tubing can be arranged and fixed together.
- The machine can't be powered on before electrical operation. Maintenance should be done while the power is shut down.
- Seal the thread hole with heat insulating materials to avoid condensation.
- Signal line and power line are separately independent, which can't share one line. [Note: the power line, signal line are provided by users. Parameters for power lines are shown as below:  $3 \times (1.0-1.5) \text{ mm}^2$ ; parameters for signal line:  $2 \times (0.75-1.25) \text{ mm}^2$  ( shielded line)]
- Connection kits and outdoor units should be connected to the power source separately. All connection kits must share one single electrical source, but its capacity and specifications should be calculated. Indoor & outdoor units should be equipped with the power leakage breaker and the overflow breaker.
- Connection kit can be installed in multiple, named as unit A, unit B.... Pay attention to the marks on the terminal block when connecting the outdoor unit with the indoor unit. In addition, the operation will be abnormal when the wiring and the tubing between indoor and outdoor machine sets are installed in different refrigerant systems.
- Energization is not to be done before it's confirmed that the connection kit have completely installed and that the outdoor and indoor installation is completed.

# Electrical wiring

## The wiring for the power line and signal line of connection kit

The wiring for the power line of connection kit, the wiring for the signal line between connection kits and outdoor units as well as the wiring between connection kits.

Total Current of valve boxes (A)	Cross Section (mm <sup>2</sup> )	Length (m)	Rated Current of Overflow Breaker (A)	Rated Current of Power Leakage Breaker (A) Leaking Current (mA) Operating Period (S)	Cross Sectional Area of Signal Line	
					Outdoor - connection kit (mm <sup>2</sup> )	Connection kit - connection kit (mm <sup>2</sup> )
<10	2	20	20	20A,30mA,0.1S or below	2cores ×0.75-2.0 mm <sup>2</sup> shielded line	
≥10 and <15	3.5	25	30	30A,30mA, 0.1S or below		
≥15 and <22	5.5	30	40	40A,30mA, 0.1S or below		
≥22 and <27	10	40	50	50A,30mA, 0.1S or below		

- The electric current of the connection kit is 0.15A (not include indoor units).
- Power cable and communication wire must be fixed firmly.
- Each connection kit must be earthed well.
- When power cable exceeds the range, thicken it appropriately.
- Shielded layer of communication wires must be connected together and be earthed at single point.
- Communication wire total length cannot exceed 1000m.

## Graphical representation for wiring

Connect the communication terminal block P and Q of the main unit of the outdoor units with the communication terminal block P and Q of the first connection kit.

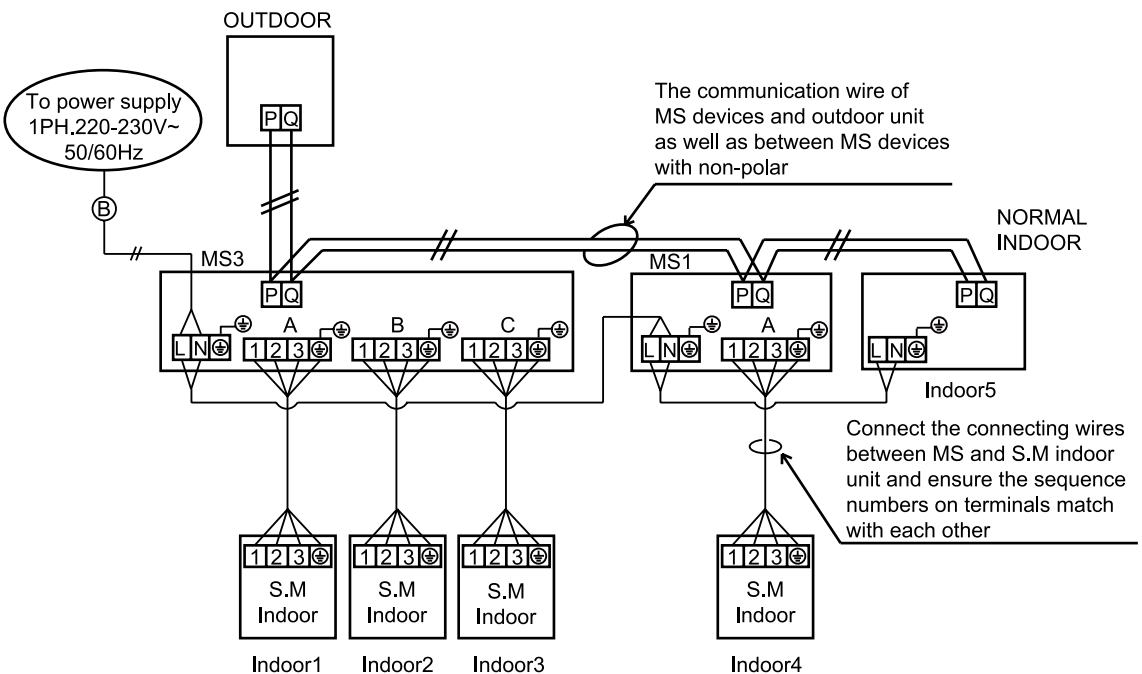

# Electrical wiring

## Notes:

- (1) The above wiring example is only for reference. The number of connection kits and indoor units shall be subject to the field installation.
- (2) Two-core non-polar communication line with shield shall be adopted for communication lines between the connection kit and the indoor/outdoor unit. The size for indoor unit and connection kit is H05RN-F4G 2.5mm
- (3) All connection kits within one system may share one over current breaker for power supply. But it's necessary to compute total current capacity specification.
- (4) For wiring harness connected to the power terminal block, the terminal shall be pressed with a round (refer to the following figure).

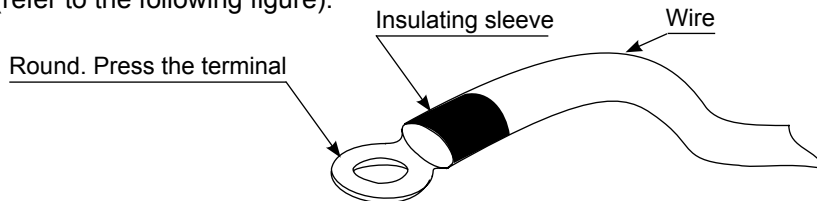

- 1) The power terminal block shall not be crimped with 2 wires of different diameters. Otherwise, poor crimp connection and looseness may lead to abnormal heating or sparking of the line.
- 2) Refer to the following figure for crimping wires with the same diameter.

Connect wires with the same diameter on both sides

It's forbidden to connect two wires on one side

Wires with different diameters are not allowed

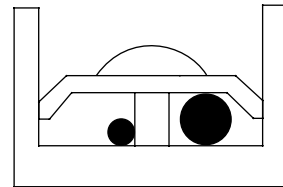
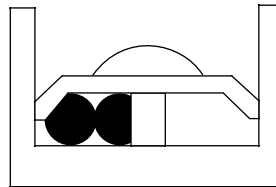
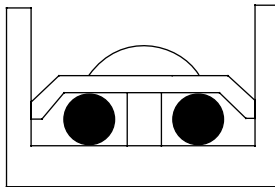

- (5) Tighten terminal screws with proper screw driver. Screw driver of small dimension will damage the screw head and fail to tighten properly.
- (6) If terminal screws are tightened excessively, they may be damaged. Refer to the following table for tightening torques of terminal screws:

Dimension of terminal screw	Tightening torque (N.m)
M3.5 (terminal block for communication line)	0.80~0.96
M4 (terminal block for power line)	1.18~1.44
M4 (terminal block for ground wire)	1.52~1.86

- (7) Power line is forbidden to the communication terminal block because it will damage the circuit control board.
- (8) Wiring of communication lines shall be within the following scope. Exceeding the limit will possibly lead to abnormal communication.
  - 1) The maximum wiring length between the outdoor machine and the valve cage, the valve cage and the indoor machine, and between valve cages is 1000 m at most. The total wiring length is 1000m at most.
  - 2) The maximum wiring length between the valve cage and the wire controller for switching working modes is 500 m at most.

# Electrical wiring

## Wiring connection

Refer to the following figure – Diagram of electrical wiring of a connection kit – for wiring connection of connection kit.

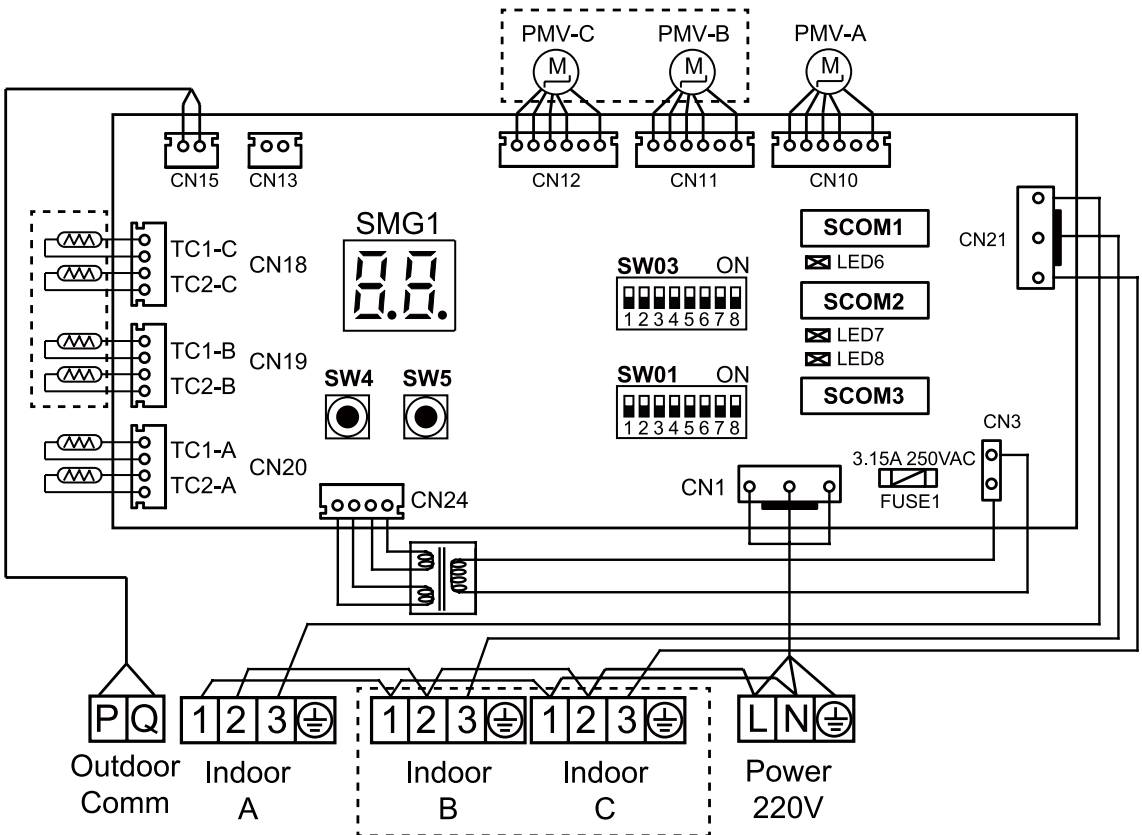

### (1) Connection communication line

Remove the cover of the electrical cabinet of the valve cage. Introduce communication lines for outdoor and indoor units to the through holes at the lower right of the electrical cabinet and crimp them on the communication terminal block respectively. Then fix the lead wires with crimping pliers to prevent the communication line from falling off under the effect of external force.

### (2) Connection of power line and ground wire

Remove the cover of the electrical cabinet of the connection kit. Introduce power lines to the through holes at the lower left of the electrical cabinet and crimp them on the communication terminal block. Then fix the power lines with crimping pliers to prevent them from falling off under the effect of external force.

- 1) Don't route communication lines and power lines together. Otherwise, it may cause malfunction or fault due to electrical disturbance.
- 2) Make sure that ground wires are properly crimped. Otherwise, grounding may be ineffective.

# Initial setting

Operate according to the following setting as necessary after refrigerant piping construction and electrical wiring construction are finished.

## 1. The choice of indoor unit:

SW01 is used for INDOOR choice, 1 is ON, 0 is OFF.

SW01_1	Indoor unit A	0	inexistence
		1	existence
SW01_2	Indoor unit B	0	inexistence
		1	existence
SW01_3	Indoor unit C	0	inexistence
		1	existence
SW01_4 ~ SW01_8	Factory Setting	0	Default setting

## 2. Code setting for the postal address of the connection kit:

SW03 is used for MS devices address setting, 1 is ON, 0 is OFF

SW03_1	Manner of set address	0		Set the address with automatism (default)						
		1		Set the address with dip switch						
		[2]	[3]	[4]	[5]	[6]	[7]	[8]	Communication address	Center controller address
		0	0	0	0	0	0	0	0# (default)	0# (default)
		0	0	0	0	0	0	1	1#	1#
		0	0	0	0	0	1	0	2#	2#
		0	0	0	0	0	1	1	3#	3#
		0	0	0	0	1	0	0	4#	4#
		0	0	0	0	1	0	1	5#	5#
		0	0	0	0	1	1	0	6#	6#
		0	0	0	0	1	1	1	7#	7#
		0	0	0	1	0	0	0	8#	8#
		0	0	0	1	0	0	1	9#	9#
		0	0	0	1	0	1	0	10#	10#
		0	0	0	1	0	1	1	11#	11#
		0	0	0	1	1	0	0	12#	12#
		0	0	0	1	1	0	1	13#	13#
		0	0	0	1	1	1	0	14#	14#
		0	0	0	1	1	1	1	15#	15#
		0	0	1	0	0	0	0	16#	16#
		0	0	1	0	0	0	1	17#	17#
		0	0	1	0	0	1	0	18#	18#
		0	0	1	0	0	1	1	19#	19#
		0	0	1	0	1	0	0	20#	20#
		0	0	1	0	1	0	1	21#	21#
		0	0	1	0	1	1	0	22#	22#
		0	0	1	0	1	1	1	23#	23#
		0	0	1	1	0	0	0	24#	24#

# Initial setting

		[2]	[3]	[4]	[5]	[6]	[7]	[8]	Communication address	Center controller address
		SW03_2 ~ SW03_8	The communication address of first indoor unit address	0	0	1	1	0	0	1
		0	0	1	1	0	1	0	26#	26#
		0	0	1	1	0	1	1	27#	27#
		0	0	1	1	1	0	0	28#	28#
		0	0	1	1	1	0	1	29#	29#
		0	0	1	1	1	1	0	30#	30#
		0	0	1	1	1	1	1	31#	31#
		0	1	0	0	0	0	0	32#	32#
		0	1	0	0	0	0	1	33#	33#
		0	1	0	0	0	1	0	34#	34#
		0	1	0	0	0	1	1	35#	35#
		0	1	0	0	1	0	0	36#	36#
		0	1	0	0	1	0	1	37#	37#
		0	1	0	0	1	1	0	38#	38#
		0	1	0	0	1	1	1	39#	39#
		0	1	0	1	0	0	0	40#	40#
		0	1	0	1	0	0	1	41#	41#
		0	1	0	1	0	1	0	42#	42#
		0	1	0	1	0	1	1	43#	43#
		0	1	0	1	1	0	0	44#	44#
		0	1	0	1	1	0	1	45#	45#
		0	1	0	1	1	1	0	46#	46#
		0	1	0	1	1	1	1	47#	47#
		0	1	1	0	0	0	0	48#	48#
		0	1	1	0	0	0	1	49#	49#
		0	1	1	0	0	1	0	50#	50#
		0	1	1	0	0	1	1	51#	51#
		0	1	1	0	1	0	0	52#	52#
		0	1	1	0	1	0	1	53#	53#
		0	1	1	0	1	1	0	54#	54#
		0	1	1	0	1	1	1	55#	55#
		0	1	1	1	0	0	0	56#	56#
		0	1	1	1	0	0	1	57#	57#
		0	1	1	1	0	1	0	58#	58#
		0	1	1	1	0	1	1	59#	59#
		0	1	1	1	1	0	0	60#	60#
		0	1	1	1	1	0	1	61#	61#
		0	1	1	1	1	1	0	62#	62#
		0	1	1	1	1	1	1	63#	63#

# Initial setting

SW03_2 ~ SW03_8	The communication address of first indoor unit address	[2]	[3]	[4]	[5]	[6]	[7]	[8]	Communication address	Center controller address	
		1	0	0	0	0	0	0	0	0#	64#
		1	0	0	0	0	0	0	1	1#	65#
		1	0	0	0	0	0	1	0	2#	66#
		...	...	...	...	...	...	...	...	.....	.....
		1	1	1	1	1	1	1	0	62#	126#
1	1	1	1	1	1	1	1	63#	127#		

## Notes:

The postal address setting is written in the chip during energization of the connection kit

1) Make sure that the postal address code is set before the connection kit is energized.

a. Dip switch setting by hand when connect with center controller, gate way and BMS

b. Dip switch setting method as below:

SW03\_2 = OFF, center controller address = communication address + 0 = communication address

SW03\_2 = ON, center controller address = communication address + 64= communication address

c. In the system, when PCB code of indoor unit is 0010451181A, you must use dip switch for address setting. SW03\_1=ON, SW03\_2=OFF, SW03\_3/SW03\_4/SW03\_5/SW03\_6/SW03\_7/SW03\_8 are address No.

d. The corresponding relation of connection kits address and indoor communication address

MS1 connection kit address= indoor communication address;

MS3 connection kit address= indoor A communication address,

MS3 connection kit address +1= indoor B communication address

MS3 connection kit address +2= indoor C communication address

Example: a system contains four connection kits (such as No. 1, No. 2, No. 3, No. 4), then connection kit address can be set as follow:

MS1 No. 1	MS1 address	Indoor address		
	0#	0#		
	MS3 address	Indoor A address	Indoor B address	Indoor C address
MS3 No. 2	1#	1#	2#	3#
MS3 No. 3	4#	4#	5#	6#
MS3 No. 4	7#	7#	8#	9#

2) Be sure to close the cover of the electrical cabinet after setting.



# Initial setting

---

## 3. Setting for LED display

### 1- SW4, SW5 button function

SW4: select the indoor unit (like SW9/10 on MRVIII-C outdoor PCB)

SW5: select the different parameter (like SW11)

### 2- The details

The LED shows 0 when the kit and indoor unit work correctly, and shows the error code if any problem happened on kit and indoor unit.

SW4: select the indoor unit (like SW9/10 on MRVIII-C outdoor PCB)

Press SW4, the LED shows "A0" & "data" alternately. "A0" -> "data"->"A0" -> "data"... Press SW4 once more, the LED shows "b0" & "data" alternately. Press SW4 once more, the LED shows "C0" & "data" alternately.

SW5: select the different parameter (like SW11)

Press SW5, the LED shows "A0" & "data" alternately. "A0" -> "data"->"A0" -> "data"... Press SW5 once more, the LED shows "A1" & "data" alternately. Press SW5 once more, the LED shows "A2" & "data" alternately. You do repeat this operation till A6 displayed.

Quit this query mode after 30 seconds automatically. The LED show the last data your queried when you entry this query mode next time.

### LED display

Code	Data content
"A0"	INDOOR UNIT A room temp(decimal)
"A1"	INDOOR UNIT A TC1 gas pipe temp. (decimal)
"A2"	INDOOR UNIT A TC2 liquid pipe temp. (decimal)
"A3"	INDOOR UNIT A Tm indoor coil temp. (decimal)
"A4"	INDOOR UNIT A physical address (hex)
"A5"	INDOOR UNIT A central address (hex)
"A6"	INDOOR UNIT A error code (decimal)
"b0"	INDOOR UNIT B room temp(decimal)
"b1"	INDOOR UNIT B TC1 gas pipe temp. (decimal)
"b2"	INDOOR UNIT B TC2 liquid pipe temp. (decimal)
"b3"	INDOOR UNIT B Tm indoor coil temp. (decimal)
"b4"	INDOOR UNIT B physical address (hex)
"b5"	INDOOR UNIT B central address (hex)
"b6"	INDOOR UNIT B error code (decimal)
"C0"	INDOOR UNIT C room temp(decimal)
"C1"	INDOOR UNIT C TC1 gas pipe temp. (decimal)
"C2"	INDOOR UNIT C TC2 liquid pipe temp. (decimal)
"C3"	INDOOR UNIT C Tm indoor coil temp. (decimal)
"C4"	INDOOR UNIT C physical address (hex)
"C5"	INDOOR UNIT C central address (hex)
"C6"	INDOOR UNIT C error code (decimal)

# Commissioning

---

1. Confirm that the cover of the electrical cabinet of the connection kit is of good sealing.
2. Conduct commissioning in accordance with the installation and use specification attached to the outdoor unit.

At the time of energization, because electronic expansion valve will start initialization (open/close), there may be click lasting for about 20s, which is normal.

## Connection kit failure code list

Failure code	Failure code definition	Resumable
1	TC1-A fault	Resumable
2	TC1-B fault	Resumable
3	TC1-C fault	Resumable
4	TC2-A fault	Resumable
5	TC2-B fault	Resumable
6	TC2-C fault	Resumable
7	Connection kit EEPROM data fault	Un-resumable
8	Communication fault between connection kit with outdoor unit	Resumable
9	Duplicate indoor unit address fault	Resumable
10	Indoor unit A fault	Resumable
11	Indoor unit B fault	Resumable
12	Indoor unit C fault	Resumable
13	Communication fault between connection kit with indoor unit A	Resumable
14	Communication fault between connection kit with indoor unit B	Resumable
15	Communication fault between connection kit with indoor unit C	Resumable
20	Outdoor unit fault	Resumable



