

Residential and Light Commercial

Catalogue 2024/25



Haier BRAND STORY

Today, in the diverse and unconventional age of the Internet, "one size fits all" products and solutions are not enough to satisfy the customer. Customers want to be treated as autonomous individuals and respected for who they are.

Everyone wants their unique lifestyle acknowledged. That is why we listen carefully to our customers in order to gain a genuine understanding of their lifestyle and requirements. Each of us deserves to live an extraordinary smart home experience, which can be simple, sophisticated, organised and enjoyable.

As a global leader, Haier, in addition to innovating its products and solutions, transforms its organisation into a connected platform. In doing so, internal and external resources are connected quickly and easily. We believe only by doing so, we can best meet our customers' expectations in this rapidly evolving world.

Join the Haier network. Create new possibilities.



CONTENTS



This warranty includes parts only.
For further details and requirement,
please contact your Haier partner

01	INTRODUCTION & FEATURES	2
02	CONTROL SYSTEMS	40
03	MONOSPLIT	42
	PEARL R290	52
	JADE SUPERMATCH	54
	EXPERT - NEW	56
	FLEXIS PLUS	58
	PEARL PREMIUM - NEW	60
	REVIVE PLUS - NEW	62
	EXPERT NORDIC - NEW	64
	PEARL NORDIC - NEW	66
	FLAIR	68
	CONSOLE - NEW	70
	1-WAY CASSETTE - NEW	72
	CASSETTE 620 - NEW	76
	ROUND FLOW CASSETTE - NEW	78
	CEILING FLOOR - NEW	84
	SLIM DUCT LOW PRESSURE - NEW	92
	DUCTED MEDIUM PRESSURE	94
	DUCTED HIGH PRESSURE	102
	AHU SOLUTION - NEW	110
	TOWER - NEW	112
	CABINET - NEW	114
04	MULTISPLIT	116
	OUTDOOR UNITS - NEW	120
	3S TANK - NEW	122
	JADE SUPERMATCH	124
	EXPERT - NEW	125
	FLEXIS PLUS	126
	PEARL PREMIUM - NEW	127
	REVIVE PLUS - NEW	128
	CONSOLE - NEW	129
	1-WAY CASSETTE - NEW	130
	CASSETTE 620 - NEW	131
	ROUND FLOW CASSETTE - NEW	132
	CEILING FLOOR - NEW	133
	SLIM DUCT LOW PRESSURE	134
	DUCTED MEDIUM PRESSURE	135
	OUTDOOR UNITS TECHINCAL DRAWINGS	136
05	MAXI SPLIT	164
	MAXI SPLIT RANGE	166
	BRANCH PIPES	168

Haier GLOBAL POSITION



WORLD'S NO.1 MAJOR APPLIANCES BRAND

Haier has been accredited with global No.1 in major household appliances by retail sales from 2008-2023, according to data from Euromonitor.



WORLD'S NO.1 SMART AC BRAND

Haier has been world's No.1 connected air conditioner brand, by retail sales in 2023, according to data from Euromonitor.



"ESG" INTERNATIONAL AWARDS

2021 ESG award 2021 BDO Environmental, Social and Governance Reporting Awards.



FORTUNE'S MOST ADMIRABLE COMPANIES

Haier Smart Home was named one of Fortune's most admired companies in the world since 2019 and is the only appliance company from Asia to receive this award.



TOP 100 MOST VALUABLE BRANDS

Haier, the world's only IoT ecosystem brand on the list for four consecutive years.



TOP 100 GLOBAL CHALLENGERS

With the global landing of the Smart Home ecosystem brand, Haier Smart Home was once again listed on the Fortune Global 500.

Haier GLOBAL NETWORK

Haier currently has 10+ R&D centres, 29 industrial parks, 122 manufacturing centres and 108 marketing centres around the world, reaching out to more than 200 countries and regions and serving 1 billion user households.

Haier has 7 major home appliance brands worldwide: Haier, Casarte, Leader, AQUA, Fisher & Paykel, GE Appliances and Candy.

Each of these brands offers the best user experience to various consumer groups in many regions and countries around the world.



10+N R&D Centers	108 Marketing Centers	29 Industrial Parks	122 Factories	200+ Countries or Regions
----------------------------	---------------------------------	-------------------------------	-------------------------	-------------------------------------

The data in this catalogue is purely indicative as the data may vary. Please be advised to check the accuracy of the data with the supplier before purchasing products.

Haier AC MILESTONES



1984

Foundation of the Haier Group in Qingdao, China.

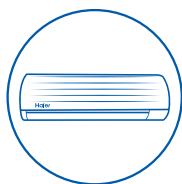

1993

Launch of the first inverter air conditioner in China.



1994

Obtaining ISO 9001 certification. Haier starts exporting air conditioners to Europe.



1996

Launch of the full Light Commercial range in China.



1999

Starts exporting air conditioners to the United States.



2014

Establishing the new R&D centre for air conditioning systems.



2015

Construction of a factory for the production of air conditioners based on the IoT (Internet of Things).



2016

Acquisition of GE Appliances. Haier obtains an absolute RAC market share in the United State



2018

2018 Acquisition of Candy. Launch of Puri-Clean air conditioners.



2023

Haier enters the renewable energy market, introducing their new range of storage solutions and photovoltaics for residential use.

Haier AC R&D CENTER



R&D Labs



Evaluation of comfort



Rain simulation



Performance testing



Safety testing



Noise testing



Electromagnetic compatibility testing



Snow simulation



Sun simulation



Reliability testing



Humidity control test



Double 85 test



Drop test

Global Certifications



Haier AC IN EUROPE

Haier is a global leading provider of smart and comfort solutions with an ambition to continuously deliver unique and advance technologies, superior design and tailor-made experiences when it comes to the environment you're in and the air you breath. We have truly increased our presence in Europe as a trustworthy brand with a premium product offering, a growing network of distributors, post-sale service and 6-year warranty.

Haier Group was established in 1984 in Qingdao by Zhang Ruimin who has centred the business around the RenDanHeYi philosophy. The well-respected model, developed and implemented by Mr. Ruimin, is revolutionary as no other company operates in this way. RenDanHeYi puts the needs of the user first, with the model's core component being "zero distance" to the customers. At Haier are empowered to provide outstanding commitment and value to our partners and end customers, keeping them at the forefront at all times.

We have since gone from strength to strength, by continuously striving for the best in class and working towards developing premium products for Global markets with IoT at the heart of our R&D and product development. We have been on the list of BrandZ

Top 100 Most Valuable Global Brands for four consecutive years as the world's first and only IoT ecosystem brand. Haier has also topped Global Major Appliances Brand Rankings by Euromonitor International for 15 consecutive years.

Haier's European HVAC operations has been active for over 30 years where we are fully supported by some of the most talented and dedicated partners and teams across Europe including, Italy, Spain, Portugal, UK, France, Central Europe and Germany. These markets carry a wide range of products which includes, Residential & Light Commercial solutions as well as Large Commercial and Heating Solutions, giving us a truly diverse offering to suit various applications from residential to larger Hotels and Retail applications.

Our total production capacity is over 27 million sets per year, supported by 16 Air Conditioning factories with 8 of them being in overseas markets. This outstanding capacity enables us to continually strive to lead the market in delivering Smart and Healthy solutions across Europe.



HVAC EUROPEAN TRAINING HUB

In 2022 Haier celebrated the opening of its new HVAC European training centre in Barcelona. The new Training Hub can facilitate a range of training programmes which is tailored to the needs of our professional network including installers and consultants. So far the Hub has welcomed close to 3000 visitors who have all been able to get close to the brand and solutions we have on offer.

The facilities are fully operational with 3 dedicated rooms, which includes products from our entire portfolio from Residential, Heating and Commercial solutions, giving visitors a truly hands on experience.

We look forward to welcoming our Distributors, Installers and Designers to come and experience Haier's HVAC Solutions first-hand.



NEW

Low Carbon Comfort, High Temperature Heating Advance Heat Pump Technology



R290
GWP=3



Monobloc
4kW-16kW



Hydro Split
4kW-16kW



Hydro All in One
4kW-16kW

Thanks to the excellent thermodynamic performance of R290 and advanced heat pump technology, the new Haier R290 high temperature series helps to reduce carbon emissions and achieve carbon neutrality goals.



Ultimate Comfort



High Efficiency



High Reliability



Super Convenience

Wide Temperature Range

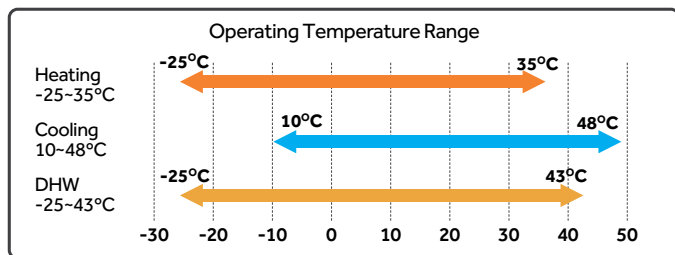

Smart Operation



Energy Monitoring + Touch Screen



Find more information in our Heating brochure

R290

More Friendly To Nature

R290 with zero Ozone Depletion Potential and Low Global Warming Potential is Eco & Ozone-friendly, which reduces the harmful effects of the planet.

Transition towards lower GWP refrigerants

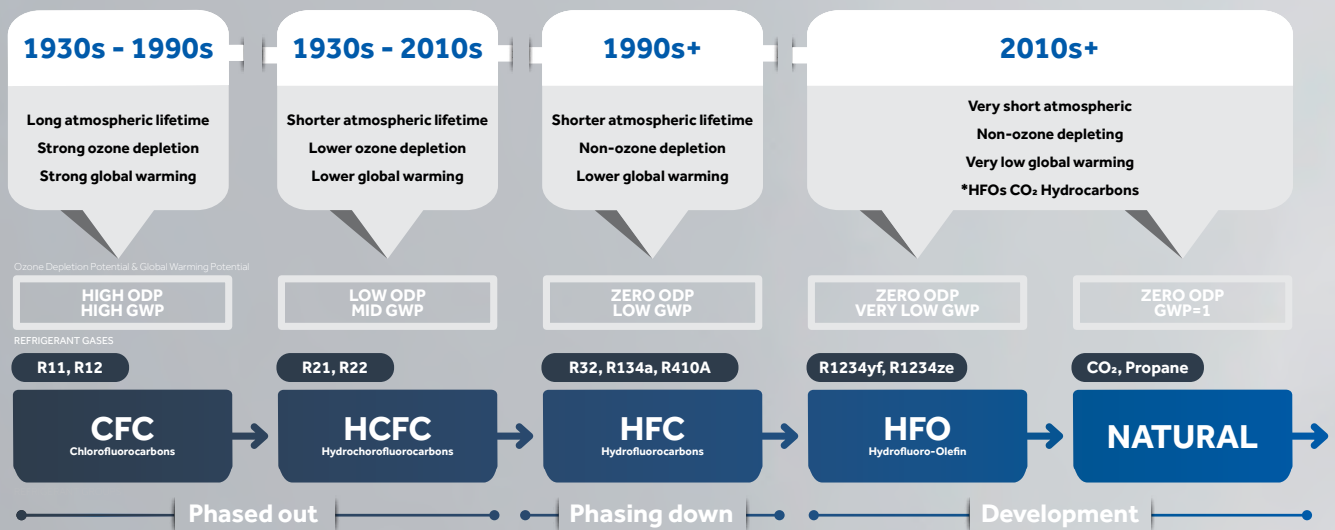

100 Year Global Warming Potential of Different Refrigerants*

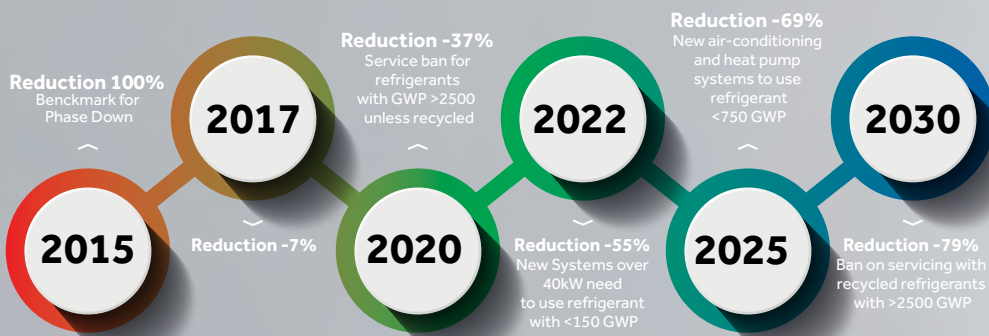
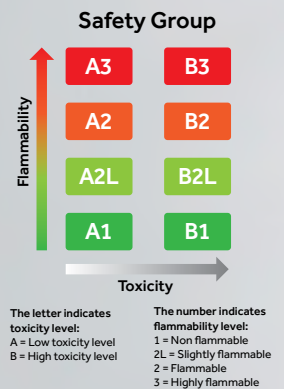
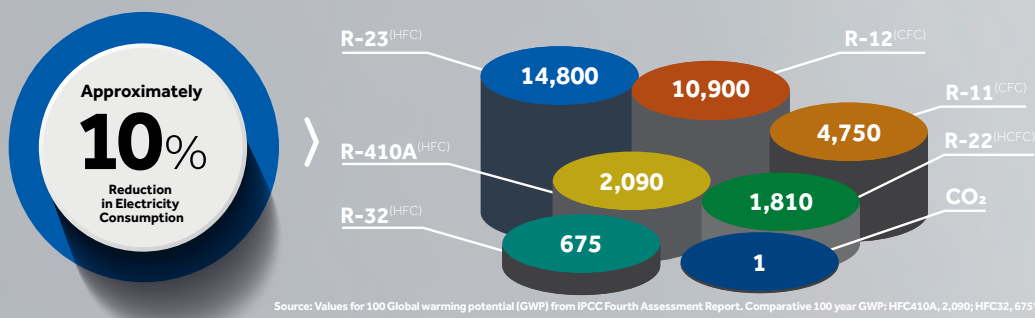

R290 Refrigerant type: Natural GWP: 3 Safety Group: A3	R744 (CO ₂) Refrigerant type: Natural GWP: 1 Safety Group: A1
R717 (Ammonia) Refrigerant type: Natural GWP: 0 Safety Group: B2L	R32 Refrigerant type: HFC GWP: 675 Safety Group: A2L
R410A Refrigerant type: HFC GWP: 2090 Safety Group: A1	

NEW

Introducing the R32 Super Match Plus Multi 3S

Revolutionary Integrated Solution of Air-conditioning and Domestic Hot Water with Heat Recovery



Integrated Heat Recovery Technology

Haier's R32 Multi 3S System integrated with a Heat Pump Water Heater is combined to provide an air to air Heating and Cooling as well as a domestic hot water. This is a perfect solution to reduce the consumption of power and replace ineffective or outdated water heating systems.

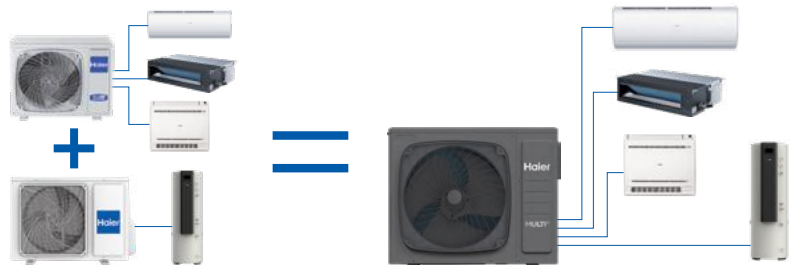

High Efficiency

The Multi 3S outdoor unit adopts DC inverter Twin Rotary compressor to ensure high energy efficiency, as an ideal solution to replace the old air electrical water heater systems.



Cooling A+++ / Heating A++



Heating DHW

Heat Recovery

The Multi 3S system adopts Heat Recovery Technology to deliver simultaneous Cooling or Heating and Domestic Hot Water (DHW). Under cooling mode, the system reuses the heat exhausted from the outdoor unit to heat the tank, which means users can enjoy free DHW.

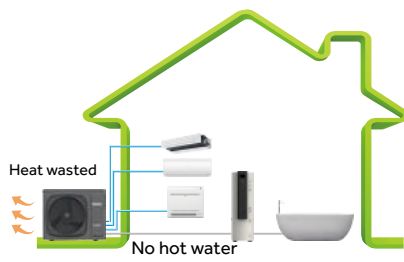

Without Heat Recovery

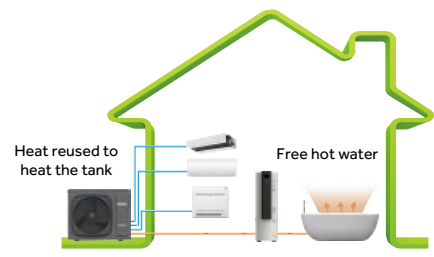

With Heat Recovery

ULTIMATE SMART

Recent years have seen the rapid development of telecommunication and IoT technology. Smart appliances have become the new household trend where Haier has taken the lead. With smart functions, you can customise the services to your needs, by controlling your air conditioner from anywhere and anytime, and so much more.

Since earlier exports to Italy in 2013, we are selling smart air conditioners to over 130 countries and regions, with sales volume exceeding 25 million units globally. In 2023, Euromonitor International, a leading market research company, named Haier as the world's leading brand for connected air conditioners (including smart air conditioners) with a 31% market share in terms of sales volumes in 2020.



Voice Control



Wi-Fi



Eco Sensor



Wi-Fi Easy Pair



3-Level-Eco



Certified as the global No.1 connected AC brand.
(Data: Euromonitor, March, 2023)

WI-FI CONTROL



Haier's new Wi-Fi "hOn" app, enables you to take control of all the Haier group appliances in your Smart Home from a single app on your smartphone or tablet.

The hOn app allows you to manage all the basic functions and much more. The app can also respond to voice commands because it is compatible with Google Assistant and Alexa.

TECHNOLOGY

Integrated Wi-Fi module

The Wi-Fi module is already built into the air conditioner. In order to control the units via smartphone or tablet it is necessary to download the hOn app from the App Store, Google Play and Huawei AppGallery. You can also use the QR Code here to locate the app.



BENEFIT

Customised Service

Here are some of the functions you can enjoy with "hOn" app.



Group Control
Control multiple units on one single smart phone device.



Smart Reminder
Sends regular notifications to user to clean the filter mesh.

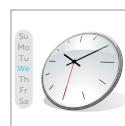

Weekly Timer
Sets temperature and fan speed for the week ahead.



Error Alert
Error code is shown on the app when it malfunctions.



Convenient Control
Controls air conditioner from anywhere and anytime via network.



Custom Program
One button for user DIY program.



Voice In APP
Built-in voice control for easy for the interaction.



Holiday Mode
Set holiday mode with one simple touch.



Energy Consumption
Know your electricity consumption in real time.

VOICE-CONTROL



Total comfort is also when words are worth more than actions. With Haier's voice control function, you can manage the main functions of one or more air conditioners, simply through verbal communication.

To use this function, you must ensure that the Haier air conditioning units are connected to the Wi-Fi network and configured with a Smart Home. (Smart Home device not supplied by Haier for compatible devices, please contact head office).

TECHNOLOGY

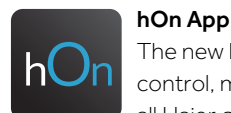

hOn App

The new hOn App is a single digital environment to control, manage and enjoy, getting the most out of all Haier group products.

With the hOn App, it is possible to control all your Haier Group smart appliances, using voice control via the most popular voice assistants. It was created, using the latest technologies for smart appliances, to make it simpler and easier to use.

BENEFIT

Customised Service

Here are some of the functions you can enjoy with "hOn" app.

Turn on/off the air conditioner.

Is the air conditioner on/off?

Set the air conditioner to 20 degree.

What is the temperature set on air conditioner?



Set the air conditioner to heat/cool/smart mode.

What mode is the air conditioner set?

Set the air conditioner to low/medium/high/auto speed.

What is the air conditioner speed?

ECO SENSOR



TECHNOLOGY

The smart sensor detects the condition of air and people's movement in real time, automatically adjusting the operating mode of the air conditioner to improve energy efficiency and optimise the users experience.

With two built-in modules, the Eco sensor uses a double area detection with a maximum angle of 120 degrees and a distance of 8m. The sensor automatically detects the presence of people inside a room and adjusts the air flow by activating the "Follow" or "Avoid" mode according to your specific needs.

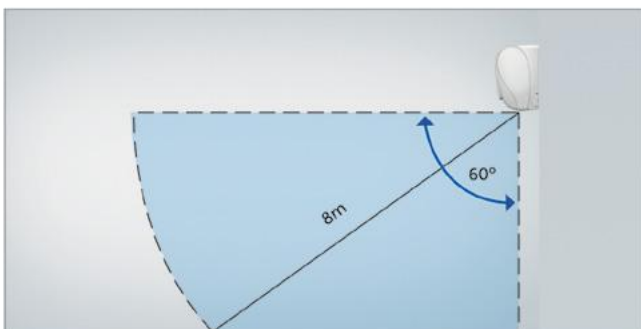

Vertical Detection Area

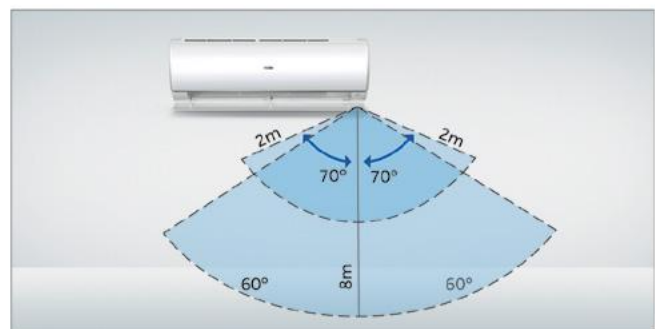

Horizontal Detection Area

A larger area of detection and the identification of people's exact location ensure the best possible user experience. The brightness sensor detects any change in light intensity. When night falls or the light goes out, the air conditioner enters "sleep" mode.

BENEFIT

Increased Comfort

If a high body temperature is detected, the fresh air flow is directed towards the person. If a low body temperature is detected, the air flow is diverted.



Energy Saving

The Echo sensor automatically detects the location and movements of people in the room. If the room is empty, the air conditioner activates the power saving mode within 20 minutes.

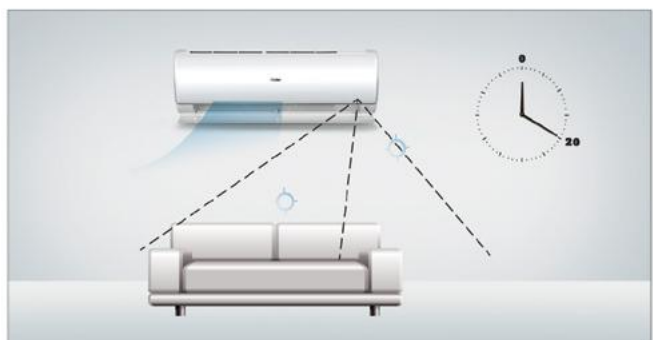

ULTIMATE HEALTH

Air pollution is becoming widespread in emerging economies. Long exposure to polluted air threatens our health. When you breathe, pollutants such as PM2,5 are inhaled. They cause discomfort, and may lead to lung or heart disease. Besides, there are numerous allergen and asthma sufferers worldwide who are vulnerable to pollen, mold spores, smoke, gases and chemicals. They need cleaner air to have better health and peace of mind. In 2020, the Covid-19 pandemic brought large-scale disruption to our lives. Therefore, having healthy air for us to breathe has become more important than ever before.

Haier has been always been dedicated to healthy air innovations. With our advanced technologies, research and development, we aim keep our air conditioner clean all the time, and ensure gentle, healthy airflow for continuous comfort.

Delivering Clean Air

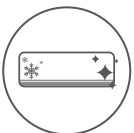

Self Clean



56° Steri-Clean



Self Hygiene

Deliver Healthy Air



Puri Clean



IFD Sterilisation



UVC Sterilisation

DELIVERING CLEAN AIR



SELF-CLEAN

Freezes the evaporator with moisture in the air and removes dirt during the defrost process, ensuring healthy air output.

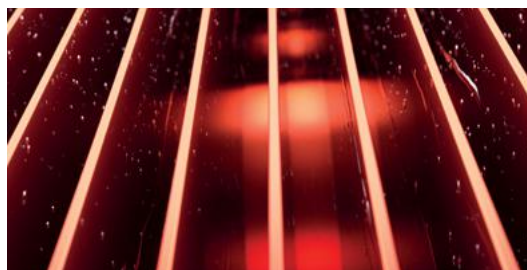

56°C STERI-CLEAN

Kills bacteria and viruses by heating the evaporator to 56°C high temperature for 30 minutes.

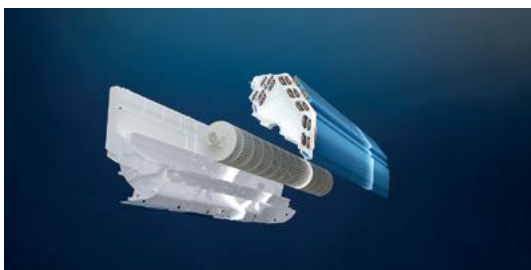

SELF-HYGIENE

The surface area of the heat exchanger of all units in the residential range is coated with silver ions to prevent the creation of mould and bacteria.

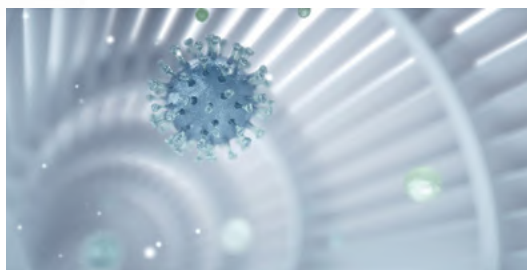

EASY-TO-CLEAN

Easy access to the fan and filter allows for deep cleaning to ensure healthy clean airflow



DELIVERING HEALTHY AIR

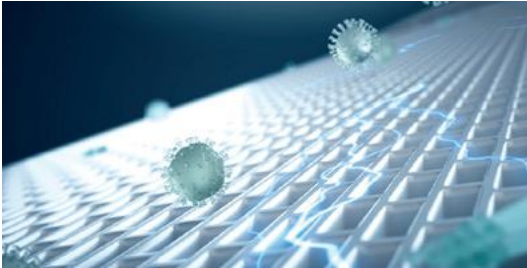

SUPER-IFD

IFD filter capable of filtering out pollutants, allergens and bacteria in the air with up to 99.9% efficiency (TÜV certified).

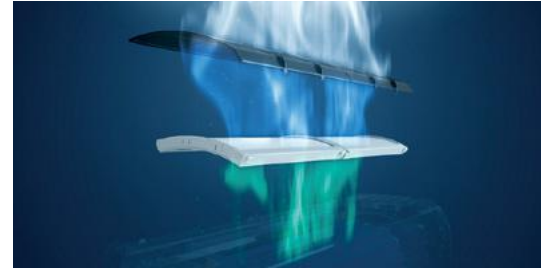

PURI-CLEAN

Utilises advanced IFD purification filter to remove all kinds of airborne pollutants and allergens with efficiency up to 99.9% while enjoy comfortable air conditioning.

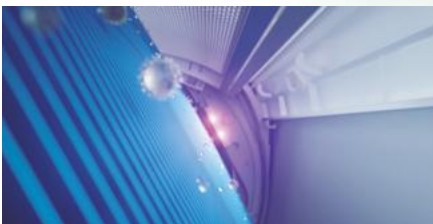
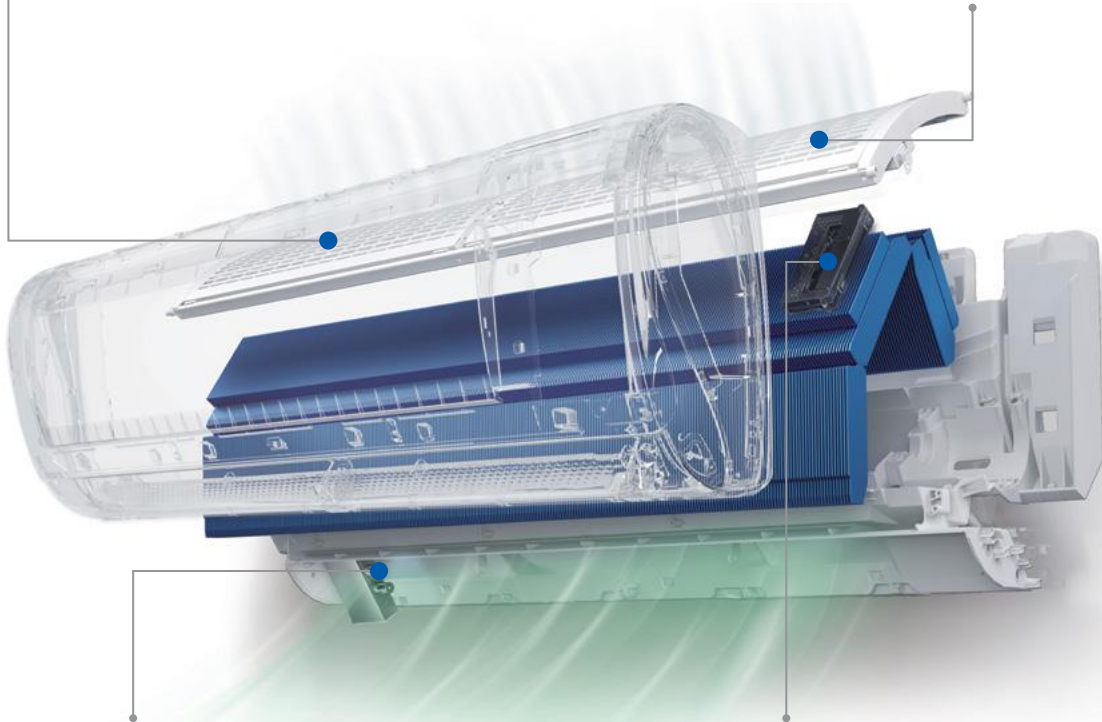

UVC STERILISATION

Emits UV light to sterilise the air passing through with efficiency up to 99.998%.



UVC PRO

Inhibits the reproduction of bacteria, by breaking down hydron and oxygen molecule and generates ionic group which inhibits bacteria and sterilises virus after contacting.



EASY CLEANING

Thanks to the easy disassembly of components it is possible to carry out a more thorough cleaning of the internal surfaces, therefore ensuring the healthiest air comes out of the air conditioner.



SELF-CLEAN FUNCTION



During operation, dirt accumulates on the evaporator. If the evaporator is not cleaned regularly, accumulated dirt reduces the thermal exchange by 15-30% and also promotes the proliferation of bacteria and mould.

TECHNOLOGY

Cold expansion technology

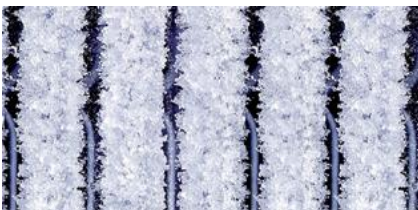

The layer of frost that forms on the evaporator/condenser generates a strong force of cold expansion that easily removes dirt from the surface.

Express washing technology

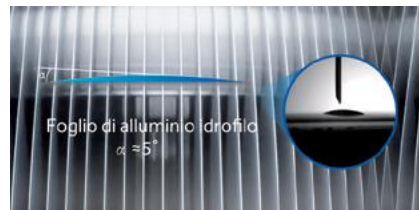

Low-angle hydrophilic aluminium foil speeds up water drainage by 20%.

Antibacterial technology



The coating contains silver nanoparticles capable of effectively killing 99% of the bacteria by inhibiting their proliferation.

The new Self Clean technology is the first of its kind to integrate the self-cleaning function of both the evaporator and the condenser. It starts with cleaning the evaporator, then switches to cleaning the condenser without stopping the compressor.

BENEFIT



Cleaner air

This innovative technology allows you to kill bacteria and keep the evaporator clean.



Increased energy efficiency

Our air conditioner always works at maximum cooling capacity with very high energy efficiency.



Savings on cleaning costs

The automated cleaning process eliminates the frequency of manual cleaning by a service engineer.

TUV Certification



SUPER-IFD STERILISATION

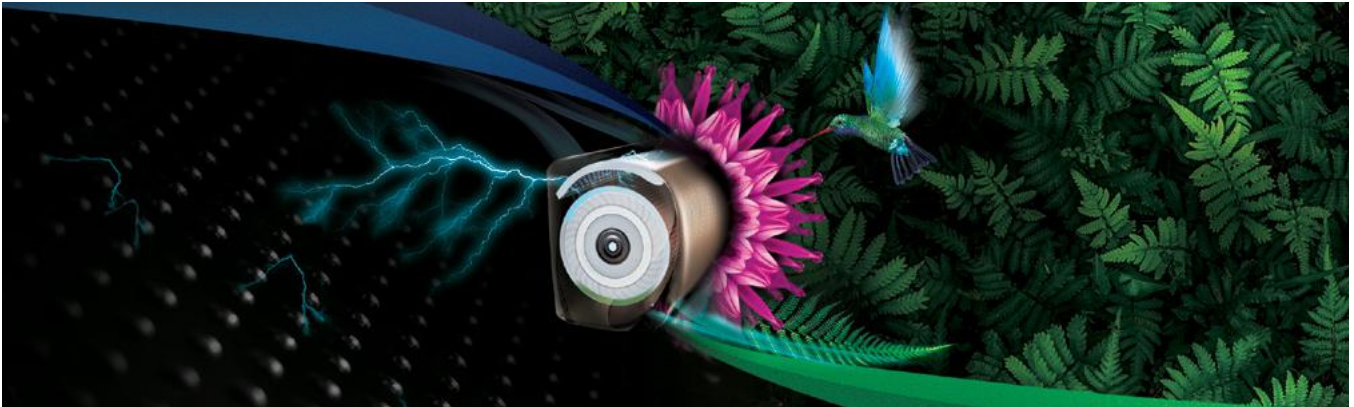

Absorbs and kills virus and bacteria in your environment with an efficiency of up to 99%.

TECHNOLOGY

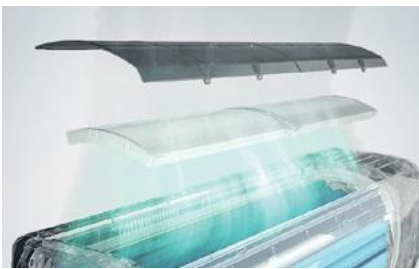

Super filter IFD

This innovative filter consists of 6818 ventilation holes, spread over a total area of 8180 cm². When air purification is activated, the generated static electricity absorbs pollutants in the environment.



Smart air quality sensor

A high-definition precision sensor installed on the suction grid detects the presence of dust and allergens in the air and displays the information on the screen in real time. When the air quality is good, the green light is turned on. When it is poor, the red alarm light is turned on.

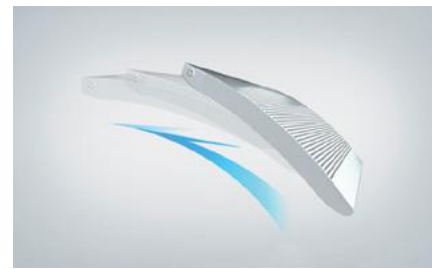

Smart purification

The IFD filter is located at the front of the evaporator. When the air quality detected in the room is poor and purification mode is activated, the IFD filter flows upwards to completely cover the air input.

BENEFIT



Deliver Healthy Air

Super-IFD Sterilisation can efficiently kill airborne bacteria & mold and effectively filter out anaphylactogen such as pollen, dust (PM2.5 & PM0.3).
Sterilisation Rate: > 99%



Easy-to-Clean

The IFD filter is in detachable design. When the filter is dirty after long-time usage. It can be washed and reused.

SGS Certification*



56°C STERI-CLEAN

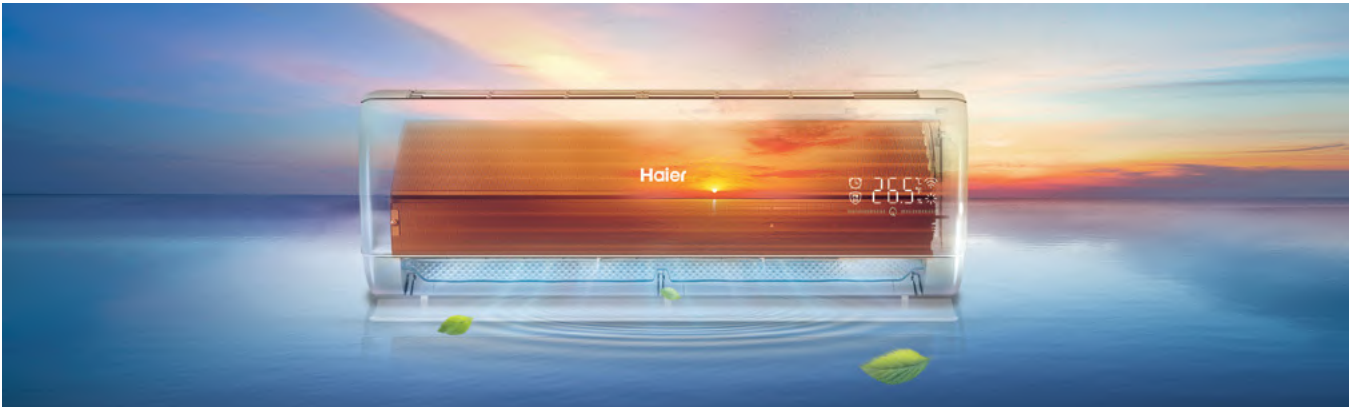

Kills bacteria and viruses by heating the evaporator to 56°C high temperature for 30+ minutes.

TECHNOLOGY

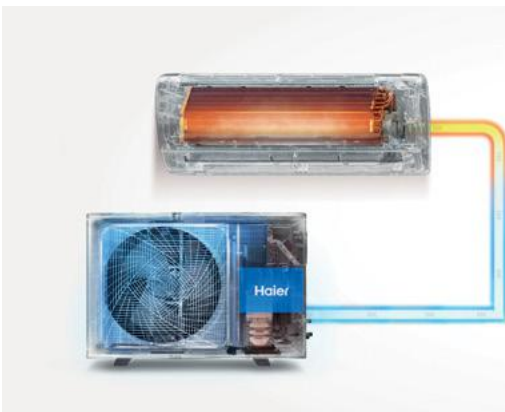

High Temperature Sterilisation

Almost no bacteria and virus can survive at 56°C for 30+ minutes based on latest research. Once the heating process is done, the evaporator is cooled down instantly to achieve better Sterilisation performance.

Smart Frequency Control

It intelligently adjusts the compressor frequency to control the coil temperature and then maintains the evaporator at 56°C high temperature.

BENEFIT

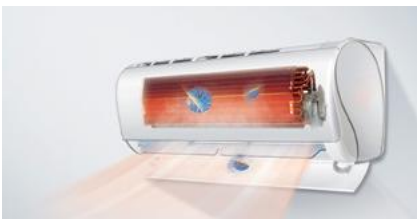

Delivering Healthier Air

56°C high temperature sterilisation dries the components inside, and kills bacteria and virus, ensuring healthy air coming out of air conditioner.



Eliminates Bacteria

As a result of this process the viruses and bacteria are eliminated from both the exchanger and other surrounding components of the machine. The result is also tested by the SGS laboratories which have shown its effectiveness.



Easy-to-Operate

The function is available via hOn APP and you can turn it on with just a simple tap.

SGS Certification*



SELF-HYGIENE

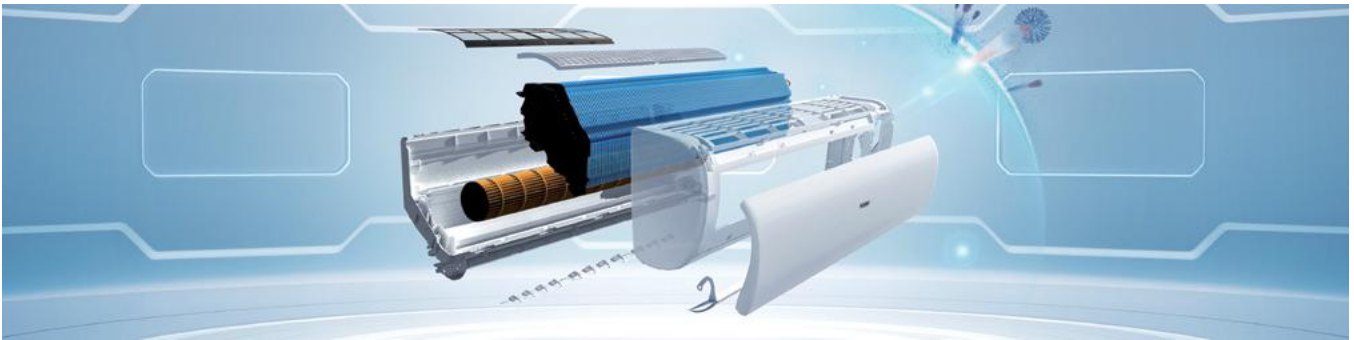

Mould and bacteria are diffused in the air. Although not all microbes compromise air quality and cause disease, some harm our health if we don't manage them well. Haier air conditioning with the Self-Hygiene incorporate silver nanoparticles into the heat exchanger surface to inhibit bacterial growth.

TECHNOLOGY

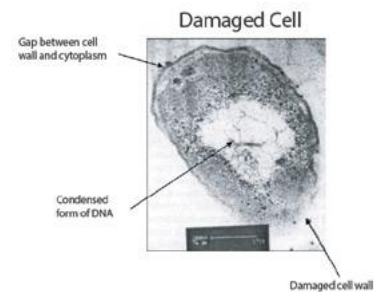
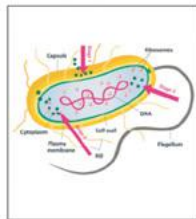
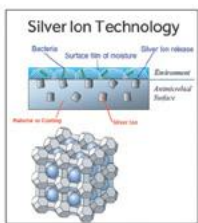

Silver nanoparticles

Molds and bacteria are widespread in the room air. They compromise air quality and cause diseases. When the air conditioner is turned on, the fan blows, and the dirt is attached to the components of the indoor unit. These elements lead to the growth of mold and bacteria. Silver nanoparticles continuously release a low level of silver ions to provide protection against molds and bacteria.

BENEFIT



Healthier air

Mould and bacteria are no longer able to grow and proliferate in the components through which air passes, and the silver ions do not cause any damage to the human body. Therefore, the air coming out of the air conditioner is always healthy.



Savings on cleaning costs

It is necessary to regularly clean and sterilise the equipment to keep the internal surface clean. This saves you money on the cost of a cleaning service technician.

SGS Certification



UVC STERILISATION



The built-in LED UV light kills airborne hazards when the air circulates from air inlet, and delivers healthy air to your room. Haier integrates UVC technology to the Commercial range, allowing duct systems to sterilise the air we breathe in offices, hotels and other commercial buildings.

TECHNOLOGY

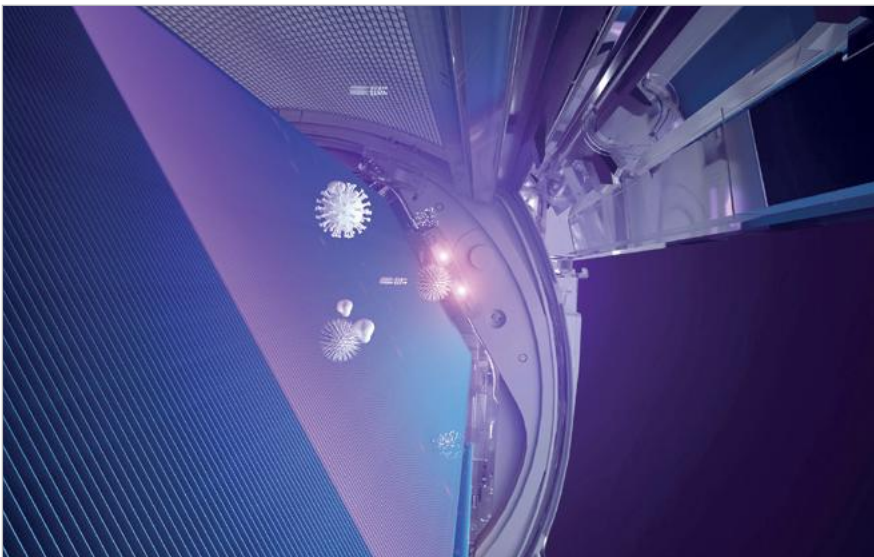

UVC Wavelength

UVC is the shorter, and more energetic wavelength ranging from 200-280nm of the sunlight spectrum. It is particularly efficient in destroying genetic material.

Built-in UV Lights

The UV lights emit rays near the air inlet where room air circulates into the AC. The airborne hazards are instantly killed when passes through the area.

Safety Lock

When the front panel is open, the air conditioner will automatically turn off the UVC lights. It avoids potential risks of direct exposure.

BENEFIT



Safe, Reliable Operation

It eliminates airborne hazards, with no harmful chemicals, no residuals, and no burden to the environment.

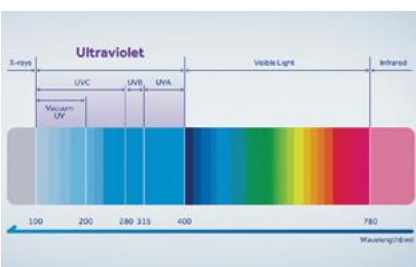

Efficient Sterilisation

Haier UVC sterilisation utilises the wave-length between 265-275 nm, which is stronger in destroying the invisible pollutants in the air.

TUV Certification*



UVC STERILISATION

Haier's UVC generator has received a Certificate of Inactivation on the Novel Coronavirus, from leading Texcell S.A, an independent viral testing laboratory in France.

The global research organisation, concluded that the Haier UVC generator inhibits **99.998%** of Novel Coronavirus (SARS-CoV-2) within their sealed test facilities.

The test was conducted in a 45L enclosed box in laboratory conditions, where the Haier UVC GENERATOR effectively inhibited SARS-CoV-2, with an efficiency up to **99.998% in 1 hour**.



TEXCELL Certification*

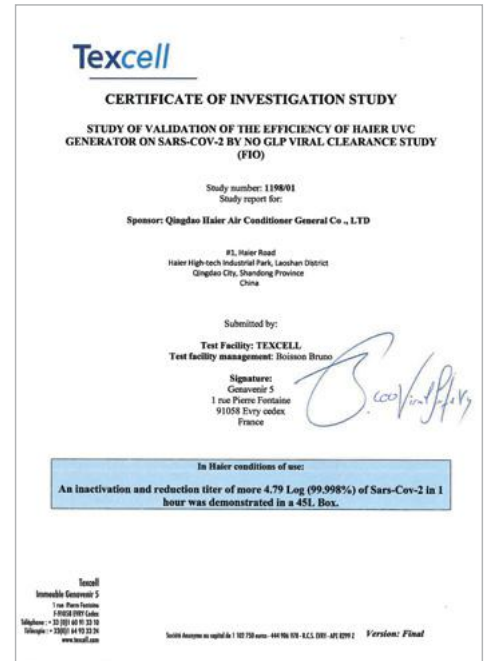

UVC PRO

UVC Pro is a technology that works in the UV ray spectre and, in particular, in two wavelengths:

- **UVC rays** inhibit bacteria and virus present in the airflow that goes through the rays generated by the lamp.
- **Vacuum UV** rays generate hydroxyl radicals that release into the environment improving the efficiency of airborne virus and bacteria inhibition.

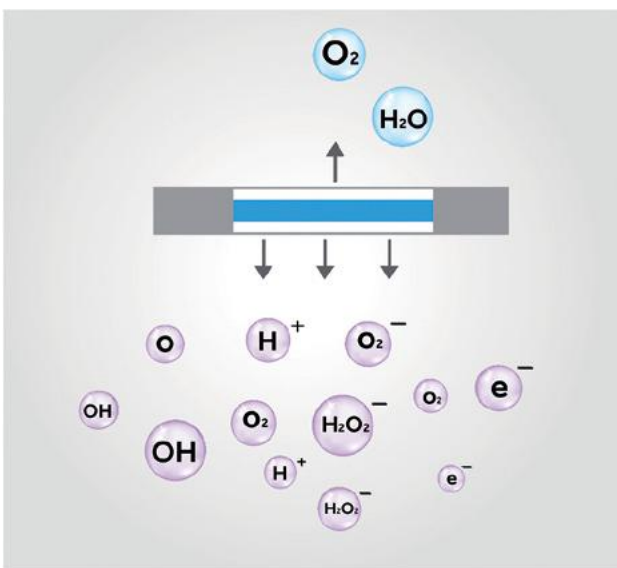

The UV Vacuum ray absorption induces the osmose and the following ionization of the water molecules. Several studies show that the irradiation of the water molecule with a lamp that has a wavelength of 185nm causes a quick elimination of the microscopic organisms, caused by the decomposition of the organic molecules present in the environment.

BENEFIT

Powerful air purification

Doubles the efficiency in air purification with UVC rays and the hydroxyl radicals generated through photolysis. Furthermore, no substance is released into the air making it environmentally conscious.

Easy to activate and manage

This function is available through the hOn APP and can be activated with a simple touch.



ULTIMATE COMFORT

As the constant advancement of air conditioning innovations, conventional cooling and heating solutions can no longer meet the evolving consumer demands. Haier provides the most comfortable air conditioning experiences to users. The PID inverter technology enables air conditioner to reach desired temperature much quicker, and maintain it precisely. It delivers faster, and more comfortable cooling performance. With innovative Triple Airflow, we utilise unique dual-blade air deflector that generates stronger, more concentrated airflow, and sends it to every corner of your room. Our solutions also provide whispering air that is quiet to down to 15db (A), and so much more.



Hyper PCB



Anti-Corrosion



Inverter PLUS



Coanda Plus



I Feel



Silence

COANDA PLUS AIRFLOW



Coanda Plus Airflow enables the air to flow further, faster and strong for even air distribution through out the room.

TECHNOLOGY

The Coanda plus airflow, made up of 3 parts under micro-perspective, delivers air in a more intuitive way, and forms the all-space circulation.

Air deflection

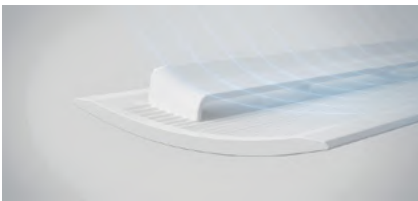

The application of the dual-layer wind deflector structure creates the unique Archimedean spiral that directs the cold airflow to the ceiling with 35° elevation.

Air speeds up



The optimal pressure expansion duct that is narrow inside and wide outside between dual layers where Venturi Effect occurs when air flows through the duct. Thus, the airflow is instantly released at high speed.

Supplemented Airflow

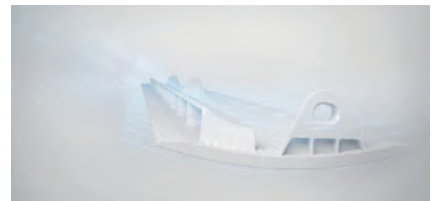

The airflow below the air deflector, absorbed tightly by the negative pressure generated by the faster airflow in-between, joins the main airflow and makes it even more stronger.

BENEFIT

Archimedean Spiral

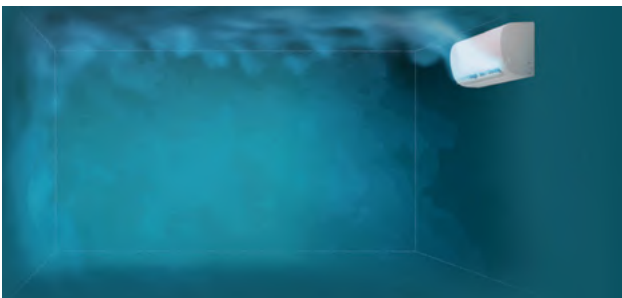

When the cooling mode is turned on, the cool air rises with 35° elevation to the ceiling, so users can avoid direct exposure to the cold airflow blowing out of the air conditioner. It is evenly dispersed from the ceiling to the floor of your room in a much more faster and more comfortable way.

Venturi Effect

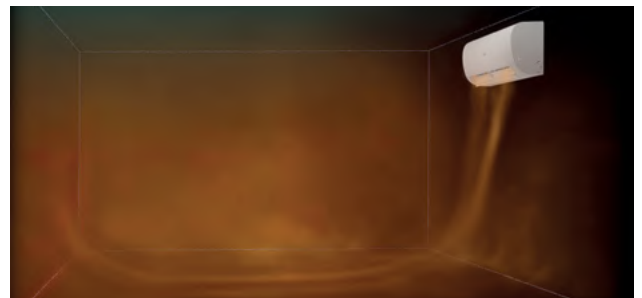

When the heating mode is turned on, the warm air is delivered directly to cover the floor. And then the warm air circulates to the whole space, and ensures the temperature is balanced at every corner of your room.

INVERTER PLUS



Compared to conventional inverter technology, Haier Inverter Plus integrates the TLFM, PID and A-PAM inverter controls to achieve intelligent control of the air conditioner, and at the same time provide maximum comfort, reliability and highly efficient performance.

TECHNOLOGY

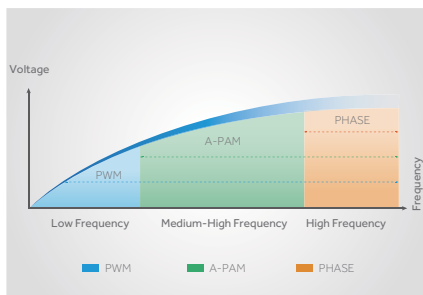

TLFM Inverter Control

TLFM (Triple Link Frequency Modulation) technology uses 3 different voltage controls to optimally manage operational efficiency at each frequency stage.

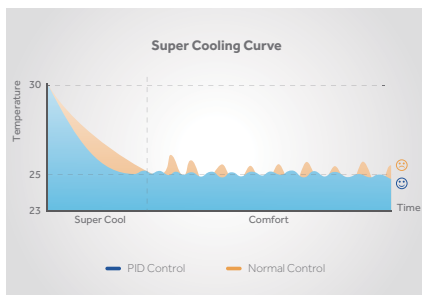

PID Inverter Control

The PID (Proportion Integration Differentiation) regulation technology optimises the operating frequency before reaching the desired temperature and then constantly makes real-time adjustments to keep the air temperature at the desired temperature.

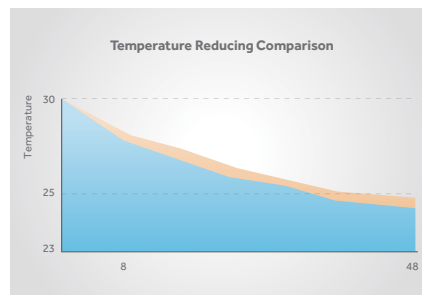

A-PAM Inverter Control

The A-PAM (Adoption-Pulse Amplitude Modulation) inverter control technology automatically adjusts the voltage of the DC bus based on the compressor load, increasing the range of operating voltage.

BENEFIT



Energy saving Performance

Inverter Plus reaches high operational efficiency at all frequency stages. The cooling/heating performance is much faster and more powerful.

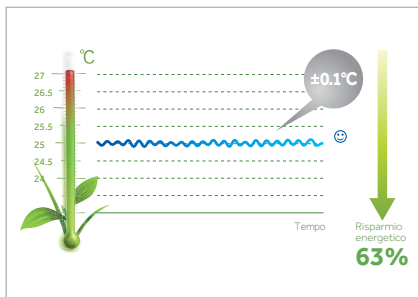

Fresh & comfortable airflow

When the air conditioner is on, Inverter Plus reaches the desired temperature much faster than a traditional system, Keeping it at a difference of $\pm 0,1$ °C thanks to a precise temperature control.



Reliability

Inverter Plus adjusts the CC voltage by achieving stable operation between 120V-264V and ideal voltage control. The fresh air is able to reach even the most distant points of the room despite the current changes.

LOW NOISE LEVEL



Have you ever been disturbed by the constant hum of an air conditioner during the day or night? In most instances having a powerful air conditioning system simply isn't enough. Power as well as comfort, and quiet operation matters whilst enjoying your free time. With a noise level of 15 dB(A) you can have it all.*

TECHNOLOGY



Optimised design of air ducts

The surface of the suction grill has been increased by 17%. The space between the evaporator, the front panel and the suction grille has also been increased. This reduces the noise level.

Optimised cross-flow fan

By improving the inclination angle of the fan to 25 degrees, the surrounding airflow undergoes a smaller deviation, minimising the fan noise.

Electronic control system

The electronic control system uses DC inverter A-PAM technology and DC fan motor. It provides high static pressure, thereby reducing the noise produced by the indoor unit during its operation.

BENEFIT

Fresh air with a low level of noise

A noise level of only 15dB(A) guarantees a silence that you can't even imagine. It's so quiet that you don't even notice it's on and it doesn't distract you from what you're doing.



75
dB(A) 10 meters
from a car



46
dB(A) Outdoor Unit



20
dB(A) the countryside at night



50
dB(A) a normal
conversation



30
dB(A) The desert
at night



15
dB(A) Enjoy silence with
optimised airflow

(Note: 15 dB(A) refers to the 9000 BTU model of the Jade Supermatch series.)

*(Source: Data tested on 9000 BTU models of the Jade Supermatch series)

HYPER PCB



Provides consistent, powerful cooling with optimised design to cope with voltage fluctuations and unexpected damages that may lead to malfunction of the air conditioner.

TECHNOLOGY

Thicker Conformal Coating

The PCB is covered with thicker conformal coating that is better than the conventional to protect against moisture, chemicals, insects and extreme temperatures.

FR-4 Material

The property of FR-4 material is flame-resistant and excelled in retaining its high mechanical values and electrical insulating qualities in both dry and humid conditions.



Compact Design

The design is smaller and takes less space than the conventional. It minimizes its influences to heat exchange efficiency of the condenser, and gives larger room to other components.

Smart Power Module

Built-in high definition temperature sensor controls the working efficiency of the compressor to achieve superior cooling and heating performance.

BENEFIT



More Stable

The PCB works stably between 130V-264V, It can start at the minimum of 130V. It enables air conditioner to provide consistent cooling in harsh environment.

More Durable

Special design and better conformal coating protect its components against various elements that reduce its lifespan.

ANTI-CORROSION



Protects the air conditioner from possible damaging caused by harsh environment in costal regions where the air is high in humidity, salt, chemicals and acid, to enhance the reliability and air conditioning performance.

TECHNOLOGY

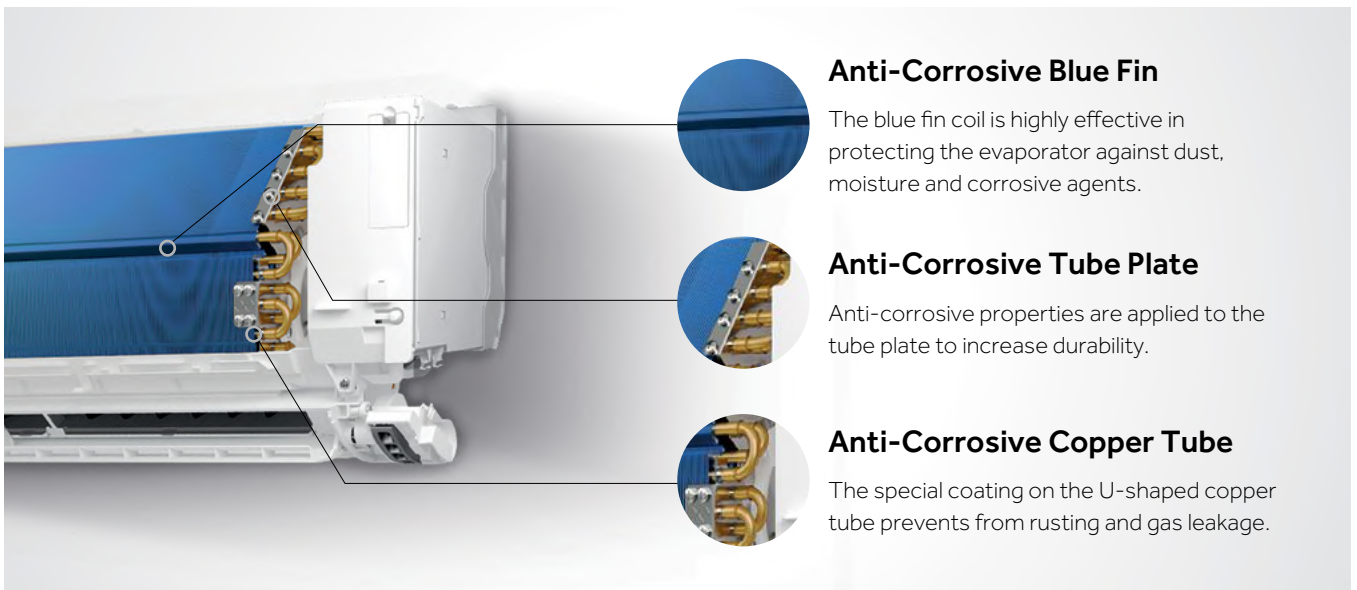

BENEFIT



More Durable

The anti-corrosive design increases the durability of the AC, and saves our money from sending for service technicians.

More Reliable

The anti-corrosive design prevents the copper tube damaging and gas leakage, to ensure the best air conditioning performance.

I FEEL



Detects the temperature around you with the remote controller no matter where you are in the room. So the air conditioner will optimise its operation based on the information to provide better air conditioning experience.

TECHNOLOGY

 A square, dark-colored device with the text "I FEEL" on its top surface. It is set against a background of a white grid with blue lines and a glowing blue light effect at the bottom.

The performance of air conditioner may vary in different working conditions. If the room temperature is higher/lower than expected, you will feel uncomfortable. I FEEL is the latest innovation in Haier's design to bring you total comfort.

Built-in Temperature Sensor

With the high definition temperature sensor built inside, the remote controller of the air conditioner can precisely monitor the temperature around the room.

Easy Control

With a simple click on the I FEEL button on the remote controller, the air conditioner receives real-time temperature data and optimise working conditions to match the desired temperature set by users.

BENEFIT

 A comparison diagram showing two air conditioner units. The left unit is labeled "Other: Without I FEEL" and has concentric circles representing temperature zones at 26°C, 27°C, and 28°C. The right unit is labeled "Haier: With I FEEL" and has concentric circles representing temperature zones at 26°C and 28°C. Below the diagram, a family of four is shown relaxing on a brown sofa.

Comfortable Experience

The function optimises the working conditions of the air conditioner to deliver airflow at the best temperature that you need.



ULTIMATE FIT

Easy installation allows the installer to work more efficiently and save time during the peak season. Haier air conditioning systems are easy to install thanks to the various optimised components. The optimised wall mounting plate provides detailed information for quick installation. At the same time, it facilitates disassembly and maintenance of the air conditioner by providing easy access to the fan motor and circuit board.



Easy Installation

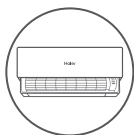

Easy Disassembly

EASY INSTALLATION



TECHNOLOGY

Positioning specifications

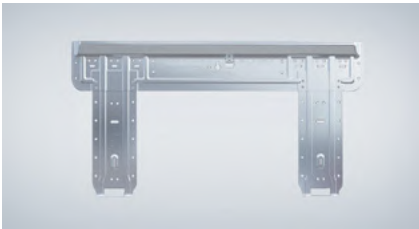

Install the mounting plate and fix the air conditioner at the appropriate height.

Easy clip (larger tubing space)



Facilitates installation with a larger workspace.

Easily accessible control panel



Simplified disassembly and maintenance without the need to dismantle the housing.

More spacing for pipes



Reduces installation time by increasing operating space to easily access the piping and electrical connections area.

Easily accessible fan motor

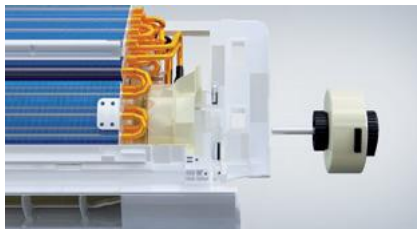

Simplifies disassembly and maintenance without the need to remove the evaporator.

Removable bottom panel



Allows the installer to connect pipes and cables without the aid of a screwdriver.

EASY-TO-DISASSEMBLE



TECHNOLOGY

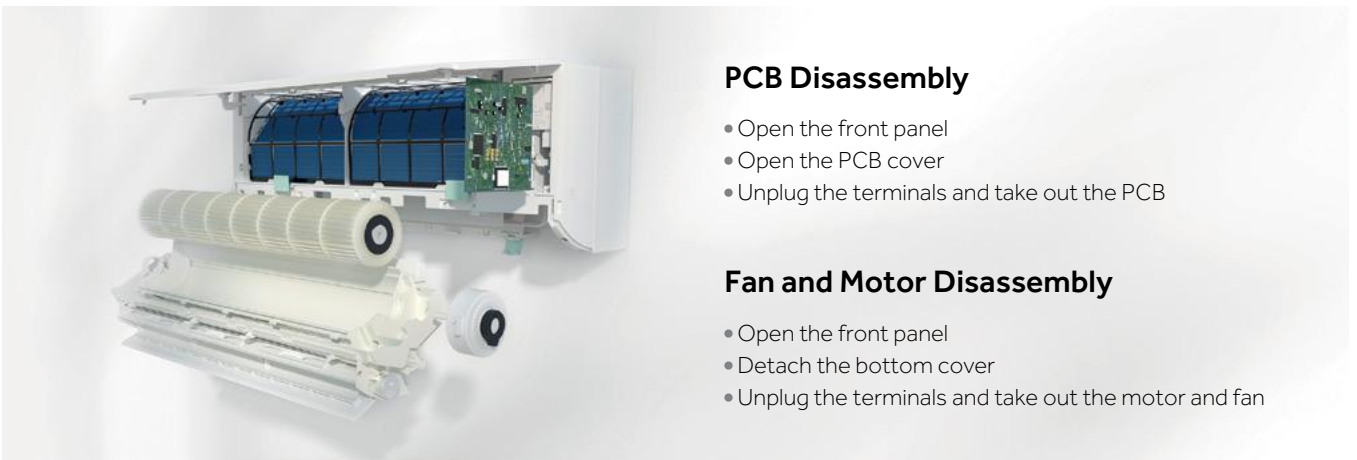

BENEFIT



80% faster PCB disassembly









90% faster motor disassembly



95% faster fan disassembly

CONTROL SYSTEMS

REMOTE CONTROLLERS						
						
SERIES	YR-HE	YR-HE2	YR-HRS01 <small>WHILE STOCKS LAST</small>	YR-HQS01	YR-HQ	HQ-HJ
PEARL R290	●	-	-	-	-	-
JADE SUPERMATCH	-	-	-	-	-	●
EXPERT	-	-	-	-	-	●
FLEXIS PLUS	-	-	-	-	-	●
PEARL PREMIUM	-	●	-	-	-	-
REVIVE PLUS	-	●	-	-	-	-
EXPERT NORDIC	-	-	-	-	-	●
PEARL NORDIC	-	●	-	-	-	-
CONSOLE	-	-	●	●	-	-
1-WAY CASSETTE	-	-	●	●	-	-
CASSETTE 620	-	-	●	●	-	-
CASSETTE ROUND FLOW	-	-	●	●	-	-
CEILING FLOOR	-	-	●	●	-	-
SLIM DUCT LOW PRESSURE	-	-	■	■	-	-
DUCTED MEDIUM PRESSURE	-	-	● HA-SB101DB module	● HA-SB101DB module	-	-
DUCTED HIGH PRESSURE	-	-	● HA-SB101DB module	● HA-SB101DB module	-	-
ALL COMFORT TOWER / TOWER	-	-	-	-	●	-
CABINET	-	-	●	●	-	-

■ *WITHOUT PANEL requires HA-SB101DB module





THE PANEL KIT (OPTIONAL) INCLUDES:

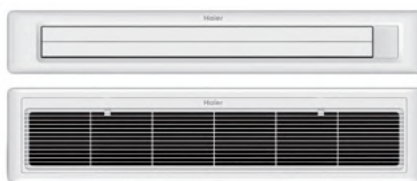

Air supply grill equipped with vertical and horizontal fins motorised 3D effect - receiver - display

Air intake grill equipped with filter



IU	PANEL (OPTIONAL)	FEATURES
AD25 - AD35	P1B-890IA/D	With display including receiver
AD50 - AD71	P1B-1210IA/D	With display including receiver

WIRED CONTROLLERS					CABLE CONNECTOR
<ul style="list-style-type: none"> ● Standard ● Optional 					 Connector cable for group connections
SERIES	HW-BA101ABT	HW-BA116ABK	HW-SA201ABK	YR-E16B	0010452854
PEARL R290	(+ WK-B interface) ●	(+ WK-B interface) ●	-	(+ WK-B interface) ●	●
JADE SUPERMATCH	(+ WK-B interface) ●	(+ WK-B interface) ●	-	(+ WK-B interface) ●	●
EXPERT	(+ WK-B interface) ●	(+ WK-B interface) ●	-	(+ WK-B interface) ●	●
FLEXIS PLUS	(+ WK-B interface) ●	(+ WK-B interface) ●	-	(+ WK-B interface) ●	●
PEARL PREMIUM	(+ WK-B interface) ●	(+ WK-B interface) ●	-	(+ WK-B interface) ●	●
REVIVE PLUS	(+ WK-B interface) ●	(+ WK-B interface) ●	-	(+ WK-B interface) ●	●
EXPERT NORDIC	(+ WK-B interface) ●	(+ WK-B interface) ●	-	(+ WK-B interface) ●	●
PEARL NORDIC	(+ WK-B interface) ●	(+ WK-B interface) ●	-	(+ WK-B interface) ●	●
CONSOLE	●	●	●	●	●
1-WAY CASSETTE	●	●	●	●	●
CASSETTE 620	●	●	●	●	●
CASSETTE ROUND FLOW	-	-	●	●	●
CEILING FLOOR	●	●	●	●	●
SLIM DUCT LOW PRESSURE	●	●	●	●	●
DUCTED MEDIUM PRESSURE	●	●	●	●	●
DUCTED HIGH PRESSURE	●	●	●	●	●
ALL COMFORT TOWER / TOWER	-	-	-	-	-

CENTRAL CONTROLLERS			
<ul style="list-style-type: none"> ● Standard ● Optional 		 Wi-Fi Accessory HIW164DBI	
SERIES	HC-SA164DBT		YCZ-A004
MULTI 1:2	●	requires YCJ-A002 for each IU	●
MULTI 1:3	●	requires 2503320A2	●
MULTI 1:4	●	requires 2503320A2	●
MULTI 1:5	●	requires 2503320A2	●
MONO R32	●	requires YCJ-A002 for each IU	●
MONO R410A	●	requires YCJ-A002 for each IU	●
MAXISPLIT	●		●



WK-B



YCJ-A002

Interfaces required for connection to wired or centralised control (see table above).



2503320A2 Unit

MONOSPLIT





FUNCTION GUIDE

ULTIMATE HEALTH



Self-Clean

CleanCool technology freezes the surface of the evaporator in contact with moisture in the air and eliminates dust in the defrosting process, thus ensuring the release of clean air.



56°C Steri-Clean

Kills bacteria and viruses by heating the evaporator to 56°C high temperature for 30 minutes.



Self-Hygiene

There are silver nanoparticles on the main components through which the air passes, this inhibits bacterial growth.



Easy to Clean

Marks another monumental step in the upgrade of healthy air innovations that ensures clean airflow out of air conditioner by allowing you to easily take out fan and filter for deep cleaning.



Puri-Clean

Puri-Clean uses an innovative IFD filter to eliminate all air pollutants and allergens with up to 99.9% efficiency, while providing comfortable air conditioning.



UVC Sterilisation

Emits UV light to sterilise the air passing through with an efficiency of 99.998%.



UVC PRO

The UVC-PRO lamp inhibits the reproduction of bacteria and sterilises viruses by generating ion clusters in the atmosphere, as a result of breaking up the hydrogen and oxygen molecules that destroy their structure after contact.



Precise Dehumidification

Keeps the air humidity at the ideal level while ensuring clean and comfortable air.



Blue Fin

Promotes the passage of condensation thanks to its hydrophilic and anti-corrosion properties.



HAF Filter

Utilises strong electrostatic charge on its surface to remove harmful micro-particles including dust, viruses and bacteria to provide healthier environment.

ULTIMATE SMART



Wi-Fi

The hOn app enables you to control and manage all Haier smart appliances in your home. All basic functions can be managed from the app such as, purification and planning functions from your smartphone. It is also compatible with Google Assistant and Alexa.



Wi-Fi Easy Pair

Easy Wi-Fi pairing now through the remote controller which has a clear Wi-Fi button for ease of use.



Voice Control

Hands-free voice control feature for Google Assistant-compatible with Haier smart air conditioners.



Eco Sensor

The air conditioner will detect the intensity of the light, the movement of people and level of activity. It will then automatically adjusting the cooling enabling the reduction of energy consumption.



3 Level Eco

New energy saving function which gives you the flexibility to set your Eco mode at 3 different levels. The savings can be up to 20%, 35% and 55% by limiting the compressor frequency.

ULTIMATE COMFORT



3D

The continuous movement of vertical and horizontal deflectors directs air flow to any point in the room.



I Feel

The remote controller has an inbuilt sensor that can measure the temperature of the room, and adjusts the temperature according to the users needs for complete comfort.



-15°C Heating

Provides optimal thermal performance during the winter thanks to the rotary compressor.



-30°C Heating

This special feature allows an optimal performance at extreme temperatures.



-10°C/-15°C/ -20°C Cooling

Works at low room temperature thanks to the high-frequency rotary compressor, optimised refrigerant system and special defrosting program.



COANDA PLUS

The special aerodynamic design of the air louvers let the airflow go further and more powerfully, while keeping low noise and energy consumption with the smoother airflow.



Long Distance Airflow

The indoor unit has been improved thanks to a special motor, fan and optimised air ducts, thus reaching up to 20 meters of range.



0.5°C Temperature Control

Allows the user to adjust the temperature in half a degree steps for more precise comfort and greater energy savings.



Double Deflector Horizontal

Provides an airflow in multiple directions to improve the user experience.

ULTIMATE FIT



Easy Clip

Facilitates installation with a larger workspace that simplifies assembly and maintenance.



Removable bottom panel

Allows the installer to connect pipes and cables without the aid of a screwdriver.



Supermatch

100% possibility of combinations of indoor and outdoor units, providing maximum flexibility of solutions.



Display Led

Clearly shows the room temperature in real time or the desired temperature on the panel.



Easy Maintenance





















Optimises the structure of the indoor unit of air conditioner by simplifying the disassembly of core components including PCB, motor and fan, making the maintenance and cleaning easier than ever before.







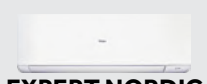













10°C vacation mode

It is activated when the ambient temperature drops below 10 °C to protect pipes during the winter period, unoccupied vacation homes, garages and basements.





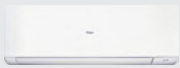









ICON GUIDE

FUNCTIONS			ULTIMATE HEALTH							ULTIMATE SMART				
<ul style="list-style-type: none"> ● Standard ● Optional 			Self Clean	Steri Clean 56°	Self Hygiene	Puri-Clean	UVC	Easy to Clean	Blue Fin	HAF Filter	Voice Control	Wi-Fi hOn	Wi-Fi EasyPair	3 Level Eco
PRODUCT LINE	kbtu /h	kW												
 PEARL R290	9-12	2,6-3,5	●						●	●	●	●		
 JADE SUPERMATCH	9-12	2,6-3,5	●	●	●	●			●		●	●		
 EXPERT	7-21	2,0-6,2	●	●			PRO	●	●	●	●	●		
 FLEXIS PLUS	7-24	2,0-7,1	●	●			●		●	●	●	●		
 NEW PEARL PREMIUM	7-24	2,0-7,0	●	●			PRO		●	●	●	●	●	●
 NEW REVIVE PLUS	9-24	5,0-6,8	●						●	●	●	●	●	●
 EXPERT NORDIC	9-12	2,6-3,5	●	●			PRO	●	●	●	●	●		
 NEW PEARL NORDIC	9-18	2,0-5,2	●	●			PRO		●	●	●	●	●	●





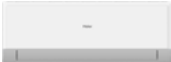
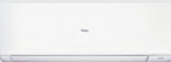















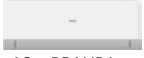

ICON GUIDE

FUNCTIONS			ULTIMATE COMFORT										
● Standard ● Optional			Eco Sensor	Precise Dehumidification	Control Temp. 0,5°C	3D Flow	Long Distance Airflow	-10°C Cooling	-15°C Cooling	-20°C Cooling	-15°C Heating	-20°C Heating	-30°C Heating
PRODUCT LINE	kbtu /h	kW											
 PEARL R290	9-12	2,6-3,5						●			●		
 JADE SUPERMATCH	9-12	2,6-3,5	●	●	●	●		●				●	
 EXPERT	7-12	2,0-3,5	●			●					●	●	
	18-21	5,0-6,2	●			●	●				●	●	
 FLEXIS PLUS	7-12	2,0-3,5	●			●					●	●	
	18-24	5,0-7,0	●			●	●				●	●	
 NEW PEARL PREMIUM	7-12	2,0-3,5			●	●					●	●	
	18-24	5,0-7,0			●	●	●				●	●	
 NEW REVIVE PLUS	9-24	5,0-6,8			●		5/6,8kW				●	●	
 EXPERT NORDIC	9-12	2,6-3,5	●			●					●		●
 NEW PEARL NORDIC	9-18	2,0-5,2			●	●	5		●				●

ICON GUIDE

FUNCTIONS			ULTIMATE COMFORT				ULTIMATE FIT		
<ul style="list-style-type: none"> ● Standard ○ Optional M Only for MultiSplit 			I Feel	Horizontal Double Deflector	Coanda Plus Airflow	10°C vacation mode	Removable bottom panel	Easy Maintenance	Super-match
PRODUCT LINE	kbtu /h	kW							
 PEARL R290	9-12	2,6-3,5			●				
 JADE SUPERMATCH	9-12	2,6-3,5	●			●	●		M
 EXPERT	7-12	2,0-3,5	●		●	●	●	●	●
	18-21	5,0-6,2	●		●	●	●	●	●
 FLEXIS PLUS	7-12	2,0-3,5	●			●	●	●	●
	18-24	5,0-7,0	●	●		●	●	●	●
 NEW PEARL PREMIUM	7-24	2,0-7,0	●		●				M
 NEW REVIVE PLUS	9-24	5,0-6,8	●		●				M
 EXPERT NORDIC	9-12	2,6-3,5	●		●	●	●	●	
 NEW PEARL NORDIC	9-18	2,0-5,2	●		●				

MONOSPLIT INVERTER

MONOSPLIT				
SERIES	2,5 kW	3,5 kW	5,0 kW	7,0 kW
PEARL R290	 AS25PBBHRA	 AS35PBBHRA		
	 1U25YEBGRA	 1U35YEBGRA		
JADE SUPERMATCH	 AS25S2SJ1FA-3	 AS35S2SJ1FA-3		
	 1U25MECFRA-3	 1U35MECFRA-3		
NEW PEARL PREMIUM	 AS25PBBHRA-PRE	 AS35PBBHRA-PRE	 AS50DPHRA-PRE	 AS71PEPHRA-PRE
	 1U25YEPFRA-PRE	 1U35MEPFRA-PRE	 1U50KEPFRA-PRE	 1U71WEPFRA-PRE
NEW REVIVE PLUS	 AS25RBAHRA-3	 AS35RBAHRA-4	 AS50RCBHRA-4	 AS68DAHRA-4
	 1U25YEGFRA-3	 1U35YESFRA-4	 1U50MERFRA-4	 1U68MRAFRA-4
EXPERT NORDIC	 AS25XCHHRA-NR	 AS35XCHHRA-NR		
	 1U25KEHFRA-NR	 1U35KEHFRA-NR		
NEW PEARL NORDIC	 AS25PCHHRA-NR	 AS35PCHHRA-NR	 AS50PDHRA-NR	
	 1U25KEFFRA-NR	 1U35KEFFRA-NR	 1U50WEFFRA-NR	
SERIES	7,1 kW			
NEW TOWER	 AP71DFMHRA		 1U71WEMFRA	

The expressed kW/Btu is for cooling classification. For exact values, see the technical data tables of the individual models.













The data in this catalogue is purely indicative as the data may vary. Please be advised to check the accuracy of the data with the supplier before purchasing products.

Range SUPER MATCH Single Split Inverter



SUPERMATCH: 100% COMBINATIONS - 50% STOCK REDUCTION

Universal indoor units for MonoSplit systems.

OUTDOOR UNIT MONOSPLIT		1U25S2SM1FA-2	1U35S2SM1FA-2	1U42S2SM1FA	1U50S2SJZFA-2	1U71S2ST1FA
INDOOR UNIT	kW	2,5 kW	3,5 kW	4,2 kW	5,0 kW	7,1 kW
 EXPERT WHITE + BLACK	2,5	●				
	3,5		●			
	5,0				●	
	7,1					●
 FLEXIS PLUS WHITE + BLACK	2,5	●				
	3,5		●			
	4,2			●		
	5,0				●	
	7,1					●
 FLAIR	10,5					
 CONSOLE	2,5	●				
	3,5		●			
	4,2			●		
	5				●	
 1-WAY CASSETTE	2,5	●				
	3,5		●			
	5				●	
	7,1					●
 CASSETTE 620	2,5	●				
	3,5		●			
	5,0				●	
 CASSETTE ROUND FLOW	7,1					●
	10,5					
	12,5					
	14,0					
	16,0					
 CEILING FLOOR	2,5	●				
	3,5		●			
	5,0				●	
	7,1					●
	10,5					
	12,5					
	14,0					
16,0						
 SLIM DUCT LOW PRESSURE	2,5	●				
	3,5		●			
	5,0				●	
	7,1					●
 DUCTED MEDIUM PRESSURE	3,5		●			
	5,0				●	
	7,1					●
	10,5					
	12,5					
	14,00					
	16,00					
 DUCTED HIGH PRESSURE	12,5					
	14,0					
	16,0					
	20,0					
	25,0					
 CABINET	10,5					
	14,0					
	16,0					
 AHU	2,5-16,0	●	●	●	●	●

The expressed kW/Btu is for cooling classification. For exact values, see the technical data tables of the individual models.

PEARL R290



AS25 - AS35



1U25 - 1U35

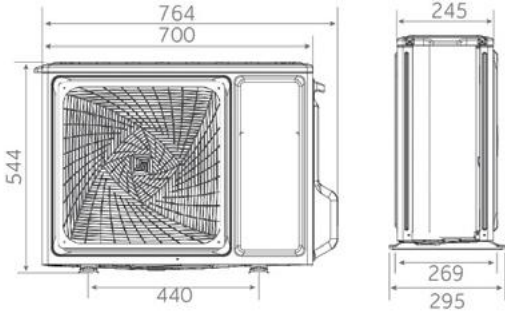

2,5 kW - 3,5 kW

PEARL R290

Haier

2,5 kW

3,5 kW

MONOSPLIT



A++ / A++



Standard YR-HE



Coanda Plus

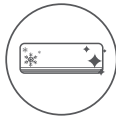

Self Clean



Integrated Wi-Fi Control



Easy Installation

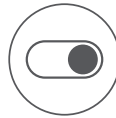

On-Off Card



Silence

- Coanda Plus Airflow
- Self-Clean
- Integrated Wi-Fi control
- Easy installation
- On - Off Card
- Low noise level

INDOOR UNIT	Model		AS25PBBHRA	AS35PBBHRA
OUTDOOR UNIT	Model		1U25YEBGRA	1U35YEBGRA
Performance data				
Output power - COOLING	nom (min-max)	kW	2,60 (0,80-2,90)	3,50 (0,80-4,00)
Output power - HEATING	nom (min-max)	kW	2,80 (0,80-3,20)	3,50 (0,80-4,10)
Absorbed power - COOLING	nom (min-max)	kW	0,804 (0,30-1,50)	1,291 (0,30-1,50)
Absorbed power - HEATING	nom (min-max)	kW	0,754 (0,30-1,50)	0,969 (0,80-4,10)
Energy class	EER	W/W	3,23	2,71
	COP	W/W	3,71	3,61
COOLING Pdesign	35 °C	kW	2,60	3,50
HEATING Pdesign	(-10 °C)	kW	2,10	2,50
Energy class	SEER		6,8 (A++)	6,2 (A++)
	SCOP		4,6 (A++)	4,6 (A++)
Annual Energy Consumption - COOLING		kWh/a	134	198
Annual Energy Consumption - HEATING		kWh/a	639	761
Indoor Unit				
Power supply		Ph/V/Hz	1/220-240/50	1/220-240/50
Treated air volume	H	m ³ /h	580	650
Dehumidification		L/h	1,2	1,4
High sound power - COOLING		dB	56	57
High sound power - HEATING		dB	56	57
Sound pressure - COOLING		dB(A)	37/32/28/18	37/33/29/19
Sound pressure - HEATING		dB(A)	37/32/28/18	37/33/29/19
Net dimensions	WxDxH	mm	805x200x292	805x200x292
Packaging dimensions	WxDxH	mm	876x272x365	876x272x365
Net/gross weight		kg	8,3/ 10,6	8,3/ 10,6
Outdoor Unit				
Power supply		Ph/V/Hz	1/220-240/50	1/220-240/50
Power cable		N x mm ²	3 x 1,0	3 x 1,5
Interconnection cable		N x mm ²	4 x 1,0	4 x 1,0
Sound power	H	dB	62	63
Sound pressure	H	dB(A)	48	49
Running current cooling/heating	Max	A	6,4/ 6,4	7,0/ 7,0
Starting current cooling/heating	Max	A	1,5/ 1,5	1,5/ 1,5
Net dimensions	WxDxH	mm	700x245x544	700x245x544
Packaging dimensions	WxDxH	mm	819x320x592	819x320x592
Net/gross weight		kg	24,5/27	24,5/27
Compressor type			Rotary Inverter	Rotary Inverter
Installation data				
Refrigerant			R290	R290
Liquid pipe	Ø	mm (inch)	6,35 (1/4)	6,35 (1/4)
Gas pipe	Ø	mm (inch)	9,52 (3/8)	9,52 (3/8)
Standard pipe length without refrigerant charge		m	10	10
Maximum pipe length		m	10	10
Maximum IU - OU elevation		m	10	10
Refrigerant charge in the factory		kg	0,31	0,31
Refrigerant charge in the factory		TCO ₂ eq	-0	-0
Additional ref. charge over std length		g/m	no additional charge allowed	
Operating limits - COOLING (in/out)	min-max	°C	21~35°C/-10~43°C	
Operating limits - HEATING (in/out)	min-max	°C	10~27°C/-15~24°C	

JADE SUPERMATCH



AS25 - AS35

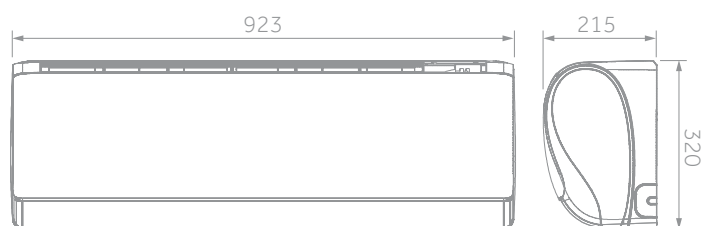

1U25 - 1U35

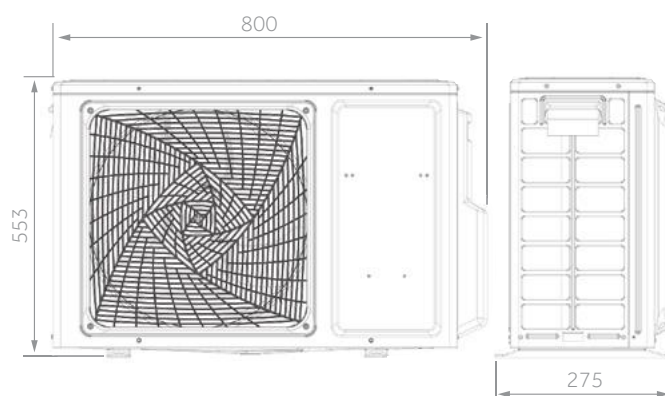

2,5 kW - 3,5 kW

JADE SUPERMATCH WHILE STOCKS LAST

Haier

2,5 kW

3,5 kW

MONOSPLIT



A+++ / A+++



Standard HR-HJ



PM 2.5
Detection

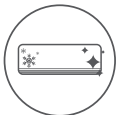

Self Clean



Precise
Dehumidification



Silence



Integrated
Wi-Fi Control



I Feel



3D



Eco Sensor



Puri Clean

- PM 2,5 detection
- Self-Clean
- Precise dehumidification
- Low noise level
- Integrated Wi-Fi control
- Easy installation
- 3D airflow: continuous movement of horizontal and vertical deflectors
- Eco Sensor
- Puri Clean

INDOOR UNIT	Model		AS25S2SJ1FA-3	AS35S2SJ1FA-3
OUTDOOR UNIT	Model		1U25MECFRA-3	1U35MECFRA-3
Performance data				
Output power - COOLING	nom (min-max)	kW	2,60 (1,00-4,00)	3,50 (1,00-4,00)
Output power - HEATING	nom (min-max)	kW	3,20 (1,10-5,40)	4,20 (1,30-5,80)
Absorbed power - COOLING	nom (min-max)	kW	0,577 (0,30-1,25)	0,795 (0,30-1,35)
Absorbed power - HEATING	nom (min-max)	kW	0,666 (0,30-1,85)	0,893 (0,30-1,85)
Energy class	EER	W/W	4,50	4,40
	COP	W/W	4,80	4,70
COOLING Pdesign	35 °C	kW	2,60	3,50
HEATING Pdesign	(-10 °C)	kW	2,60	2,65
Energy class	SEER		8,75 (A+++)	8,75 (A+++)
	SCOP		5,10 (A+++)	5,10 (A+++)
Annual Energy Consumption - COOLING		kWh/a	104	140
Annual Energy Consumption - HEATING		kWh/a	714	727
Indoor Unit				
Power supply		Ph/V/Hz	1/220-240/50	1/220-240/50
Treated air volume	H	m ³ /h	550	600
Dehumidification		L/h	1,2	1,6
High sound power - COOLING		dB	56	57
High sound power - HEATING		dB	56	57
Sound pressure - COOLING		dB(A)	36/32/29/15	37/33/30/16
Sound pressure - HEATING		dB(A)	36/32/29/15	37/33/30/16
Net dimensions	WxDxH	mm	923x215x320	923x215x320
Packaging dimensions	WxDxH	mm	1032x318x418	1032x318x418
Net/gross weight		kg	12,0/15,2	12,0/15,2
Outdoor Unit				
Power supply		Ph/V/Hz	1/220-240/50	1/220-240/50
Power cable		N x mm ²	3 x 1,5	3 x 1,5
Interconnection cable		N x mm ²	4 x 1,0	4 x 1,0
Sound power	H	dB	61	62
Sound pressure	H	dB(A)	48	49
Running current cooling/heating	Max	A	8,0/8,0	8,0/8,0
Starting current cooling/heating	Max	A	1,5/1,5	1,5/1,5
Net dimensions	WxDxH	mm	800x275x553	800x275x553
Packaging dimensions	WxDxH	mm	902x375x607	902x375x607
Net/gross weight		kg	29,8/33,6	29,8/33,6
Compressor type			Rotary Inverter	Rotary Inverter
Installation data				
Refrigerant			R32	R32
Liquid pipe	∅	mm (inch)	6,35 (1/4)	6,35 (1/4)
Gas pipe	∅	mm (inch)	9,52 (3/8)	9,52 (3/8)
Standard pipe length without refrigerant charge		m	7	7
Maximum pipe length		m	20	20
Maximum IU - OU elevation		m	10	10
Refrigerant charge in the factory		kg	0,74	0,74
Refrigerant charge in the factory		TCO ₂ eq	0,50	0,50
Additional ref. charge over std length		g/m	20	20
Operating limits - COOLING (in/out)	min-max	°C	21-35°C/-10-43°C	
Operating limits - HEATING (in/out)	min-max	°C	10-27°C/-20-24°C	

The data in this catalogue is purely indicative as the data may vary. Please be advised to check the accuracy of the data with the supplier before purchasing products.



reddot winner 2022



AS25 - AS35 - AS50 - AS71

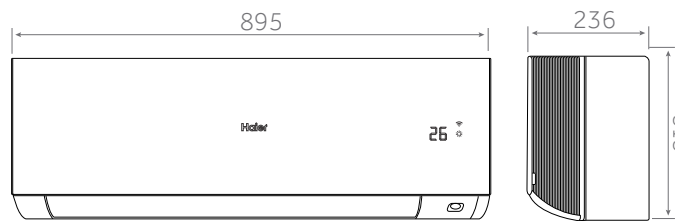

1U25 - 1U35

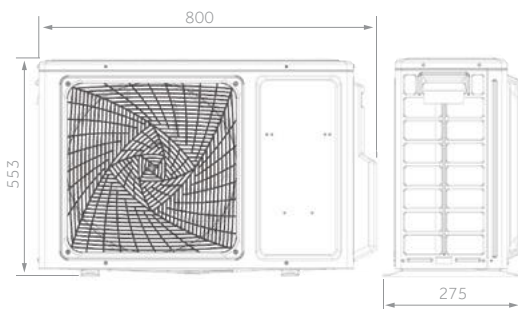

1U50

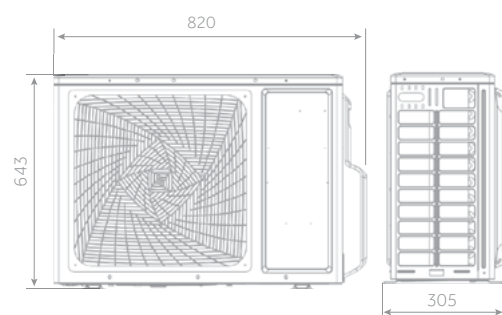

1U71

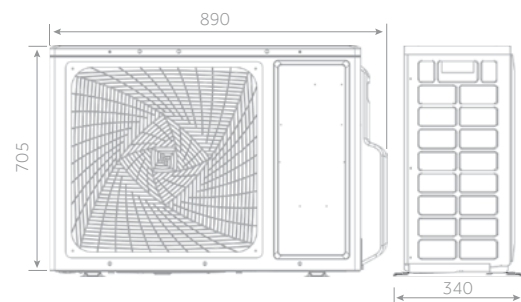

2,5 kW - 3,5 kW

5,0 kW

7,1 kW

EXPERT ^{NEW}

Haier

MONOSPLIT

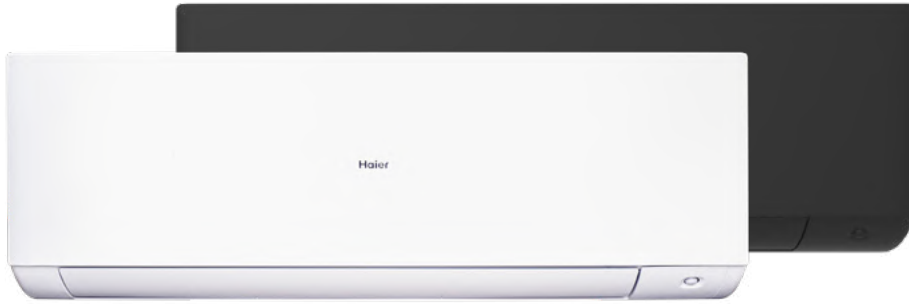

A+++ / A++

2,8 kW

3,5 kW

5,0 kW

7,1 kW



Standard HR-HJ



Easy Installation



I Feel

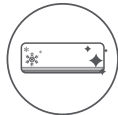

Self Clean



Eco Sensor



Integrated Wi-Fi Control

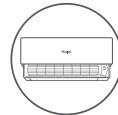

Easy to Disassemble

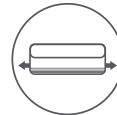

2-Way Piping Design



UVC Pro

- Easy Installation
- I Feel
- Self-Clean
- Eco Sensor
- Integrated Wi-Fi control
- Easy to Clean
- 2-Way Pipe Design
- UVC Pro
- 3D airflow: continuous movement of horizontal and vertical deflectors

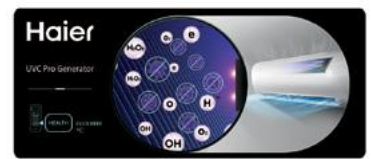

INDOOR UNIT WHITE	Model		AS25XCAHRA	AS35XCAHRA	AS50XCAHRA	AS71XCAHRA
INDOOR UNIT BLACK	Model		AS25XCAHRA-MB	AS35XCAHRA-MB	AS50XCAHRA-MB	AS71XCAHRA-MB
OUTDOOR UNIT	Model		1U25S2SM1FA-2	1U35S2SM1FA-2	1U50S2S2JFA-2	1U71S2ST1FA
Performance data						
Output power - COOLING	nom (min-max)	kW	2,80 (0,80-3,20)	3,50 (1,00-4,00)	5,00 (1,40-5,50)	6,20(2,20-7,00)
Output power - HEATING	nom (min-max)	kW	3,20 (0,80-4,20)	4,20 (1,00-5,20)	5,60 (1,70-6,20)	6,80(2,40-7,80)
Absorbed power – COOLING	nom (min-max)	kW	0,651 (0,20-1,20)	0,875 (0,30-1,40)	1,470 (0,50-2,00)	1,92(0,70-2,60)
Absorbed power – HEATING	nom (min-max)	kW	0,761 (0,30-1,50)	1,037 (0,50-1,60)	1,509 (0,52-2,30)	1,83(0,60-2,90)
Energy class	EER	W/W	4,30	4,00	3,40	3,23
	COP	W/W	4,20	4,05	4,00	3,71
COOLING Pdesign	35 °C	kW	2,80	3,50	5,00	6,20
HEATING Pdesign	(-10 °C)	kW	2,50	2,80	4,60	5,60
Energy class	SEER		8,80 (A+++)	8,50 (A+++)	6,60 (A++)	6,80 (A++)
	SCOP		4,75 (A++)	4,75 (A++)	4,60 (A++)	4,00 (A+)
Annual Energy Consumption - COOLING		kWh/a	111	144	265	320
Annual Energy Consumption - HEATING		kWh/a	737	825	1400	1960
Indoor Unit						
Power supply		Ph/V/Hz	1/220-240/50	1/220-240/50	1/220-240/50	1/220-240/50
Treated air volume	H	m ³ /h	730	800	880	920
Dehumidification		L/h	1,2	1,6	2,0	2,8
High sound power - COOLING		dB	56	57	60	65
High sound power - HEATING		dB	56	57	60	65
Sound pressure - COOLING		dB(A)	39/32/25/16	40/33/26/17	45/37/29/20	47/45/37/29
Sound pressure - HEATING		dB(A)	39/32/25/16	40/33/26/17	45/37/29/20	47/45/37/29
Net dimensions	WxDxH	mm	895x236x313	895x236x313	895x236x313	895x313x236
Packaging dimensions	WxDxH	mm	964x386x316	964x386x316	964x386x316	964x386x316
Net/gross weight		kg	11,3/14,0	11,3/14,0	11,6/14,2	12,4/14,8
Outdoor Unit						
Power supply		Ph/V/Hz	1/220-240/50	1/220-240/50	1/220-240/50	1/220-240/50
Power cable		N x mm ²	3 x 1,5	3 x 1,5	3 x 2,5	3 x 2,5
Interconnection cable		N x mm ²	4 x 1,0	4 x 1,0	4 x 1,0	4 x 1,0
Sound power	H	dB	59	63	63	68
Sound pressure	H	dB(A)	48	49	50	53
Running current cooling/heating	Max	A	6,8/6,8	7,2/7,2	10,68/10,68	11,8/13
Starting current cooling/heating	Max	A	1,5/1,5	1,5/1,5	2,0/2,0	2,0/2,0
Net dimensions	WxDxH	mm	800x275x553	800x275x553	820x305x643	890x340x705
Packaging dimensions	WxDxH	mm	902x375x607	902x375x607	940x390x697	1046x460x780
Net/gross weight		kg	27,6/30,4	30/32,9	35,7/38,5	44/48
Compressor type			Rotary Inverter	Rotary Inverter	Twin rotary inverter	Twin rotary inverter
Installation data						
Refrigerant			R32	R32	R32	R32
Liquid pipe	∅	mm (inch)	6,35 (1/4)	6,35 (1/4)	6,35 (1/4)	9,52 (3/8)
Gas pipe	∅	mm (inch)	9,52 (3/8)	9,52 (3/8)	12,70 (1/2)	15,88(5/8)
Standard pipe length without refrigerant charge		m	7	7	7	7
Maximum pipe length		m	20	20	25	50
Maximum IU - OU elevation		m	10	10	15	30
Refrigerant charge in the factory		kg	0,63	0,78	1,10	1,23
Refrigerant charge in the factory		TCO2eq	0,43	0,53	0,74	0,83
Additional ref. charge over std length		g/m	20	20	20	20
Operating limits - COOLING (in/out)	min-max	°C	21-35/-20-43			
Operating limits - HEATING (in/out)	min-max	°C	10-27/-20-24			

FLEXIS PLUS



AS25 - AS35 - AS42

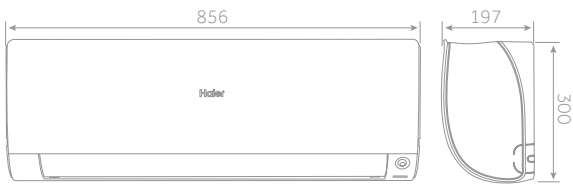

AS50



AS71

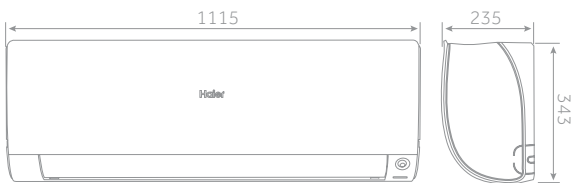

MOUNTING DIMENSIONS

AS25-AS35-AS42-AS50

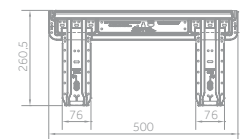

AS71

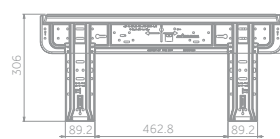

2,5 kW - 4,2 kW

5,0 kW

7,1 kW

1U25 - 1U35 - 1U42

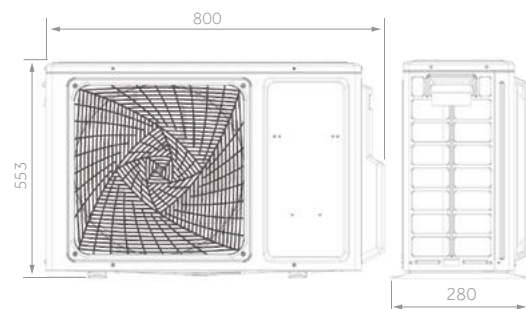

1U50

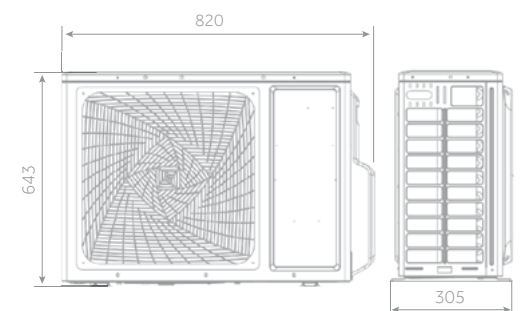

1U71

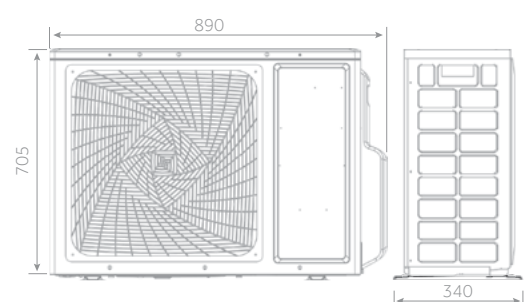

FLEXIS PLUS

Haier



A+++ / A++

2,6 kW

3,5 kW

5,2 kW

7,0 kW



Standard HQ-HJ



- Self-Clean
- Eco sensor
- Easy installation
- Low noise level
- Integrated Wi-Fi control
- 56°C Steri-Clean
- 3D airflow: continuous movement of horizontal and vertical deflectors
- Heating cable w/Nordic version
- UVC Sterilisation



INDOOR UNIT BLACK	Model	AS25S2SF1FA-MB3	AS35S2SF1FA-MB3	AS50S2SF1FA-MB3	AS71S2SF1FA-MB3	
INDOOR UNIT WHITE	Model	AS25S2SF1FA-MW3	AS35S2SF1FA-MW3	AS50S2SF1FA-MW3	AS71S2SF1FA-MW3	
OUTDOOR UNIT STANDARD	Model	1U25S2SM1FA-2	1U35S2SM1FA-2	1U50S2SJ2FA-2	1U71S2ST1FA	
OUTDOOR UNIT NORDIC	Model	1U25MEHFRA-1	1U35MEHFRA-1	1U50KEFRA-1	-	
Performance data						
Output power - COOLING	nom (min-max)	kW	2,60 (0,80-3,20)	3,50 (1,00-4,00)	5,20 (1,40-6,00)	7,00 (2,20-7,50)
Output power - HEATING	nom (min-max)	kW	3,20 (0,80-4,20)	4,20 (1,00-5,20)	6,00 (1,40-6,90)	8,00 (2,40-8,50)
Absorbed power - COOLING	nom (min-max)	kW	0,650 (0,20-1,20)	0,870 (0,30-1,50)	1,413 (0,50-2,00)	2,167 (0,70-2,50)
Absorbed power - HEATING	nom (min-max)	kW	0,800 (0,30-1,50)	1,102 (0,50-1,60)	1,500 (0,52-2,35)	2,156 (0,70-2,90)
Energy class	EER	W/W	4,00	4,00	3,60	3,23
	COP	W/W	4,00	3,81	4,00	3,71
COOLING Pdesign	35 °C	kW	2,60	3,50	5,20	7,00
HEATING Pdesign	(-10 °C)	kW	2,40	2,80	4,60	5,60
Energy class	SEER		8,50 (A+++)	8,50 (A+++)	7,20 (A++)	7,10 (A++)
	SCOP		4,60 (A++)	4,60 (A++)	4,60 (A++)	4,00 (A+)
Annual Energy Consumption - COOLING		kWh/a	107	144	253	345
Annual Energy Consumption - HEATING		kWh/a	731	854	1400	1959
Indoor Unit						
Power supply		Ph/V/Hz	1/220-240/50	1/220-240/50	1/220-240/50	1/220-240/50
Treated air volume	H	m ³ /h	600	650	900	1100
Dehumidification		L/h	1,2	1,6	2,0	2,8
High sound power - COOLING		dB	53	55	57	60
High sound power - HEATING		dB	53	55	57	60
Sound pressure - COOLING		dB(A)	38/32/25/16	39/33/26/17	45/41/37/28	47/43/37/33
Sound pressure - HEATING		dB(A)	38/32/25/19	39/33/26/20	45/41/37/28	47/43/37/33
Net dimensions	WxDxH	mm	856x197x300	856x197x300	999x225x323	1115x235x343
Packaging dimensions	WxDxH	mm	952x283x389	952x283x389	1100x314x420	1202x319x432
Net/gross weight		kg	9,5/12,0	9,5/12,0	12,0/15,0	15,2/18,2
Outdoor Unit						
Power supply		Ph/V/Hz	1/220-240/50	1/220-240/50	1/220-240/50	1/220-240/50
Power cable		N x mm ²	3 x 1,5	3 x 1,5	3 x 2,5	3 x 2,5
Interconnection cable		N x mm ²	4 x 1,0	4 x 1,0	4 x 1,0	4 x 1,0
Sound power	H	dB	59	61	63	70
Sound pressure	H	dB(A)	47	48	51	57
Running current cooling/heating	Max	A	6,8/6,8	7,2/7,2	10,68/10,68	13,0/13,0
Starting current cooling/heating	Max	A	1,5/1,5	1,5/1,5	2,0/2,0	2,0/2,0
Net dimensions	WxDxH	mm	800x280x553	800x280x553	820x305x643	890x340x705
Packaging dimensions	WxDxH	mm	902x375x614	902x375x614	940x390x697	1046x460x780
Net/gross weight		kg	27,6/30,4	30,0/32,9	37,8/40,5	45,0/50,0
Compressor type			Rotary inverter	Rotary inverter	Twin rotary inverter	Twin rotary inverter
Installation data						
Refrigerant			R32	R32	R32	R32
Liquid pipe	∅	mm (inch)	6,35 (1/4)	6,35 (1/4)	6,35 (1/4)	9,52 (3/8)
Gas pipe	∅	mm (inch)	9,52 (3/8)	9,52 (3/8)	12,70 (1/2)	15,88 (5/8)
Standard pipe length without refrigerant charge		m	7	7	7	7
Maximum pipe length		m	20	20	25	50
Maximum IU - OU elevation		m	10	10	15	30
Refrigerant charge in the factory		kg	0,63	0,78	1,10	1,30
Refrigerant charge in the factory		TCO ₂ eq	0,43	0,53	0,74	0,88
Additional ref. charge over std length		g/m	20	20	20	45
Operating limits - COOLING (in/out)	min-max	°C	21-35/-20-43			
Operating limits - HEATING (in/out)	min-max	°C	10-27/-20-24			

The data in this catalogue is purely indicative as the data may vary. Please be advised to check the accuracy of the data with the supplier before purchasing products.



AS25 - AS35

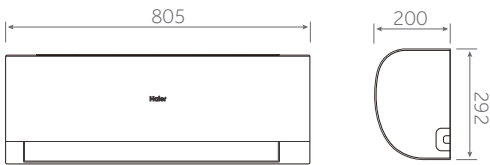

AS50

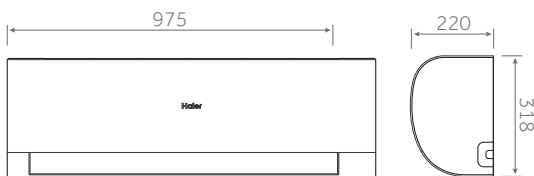

AS71

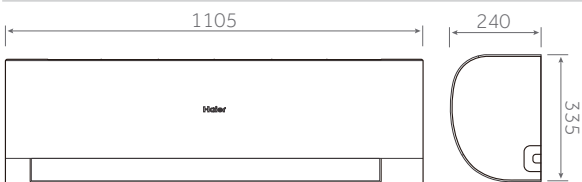

MOUNTING DIMENSIONS

AS25 - AS35

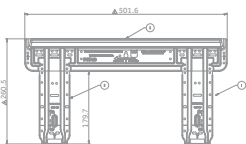

AS50

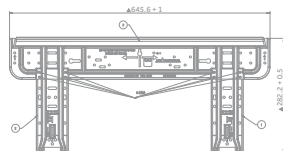

AS71

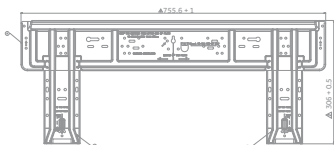

1U25 - 1U35

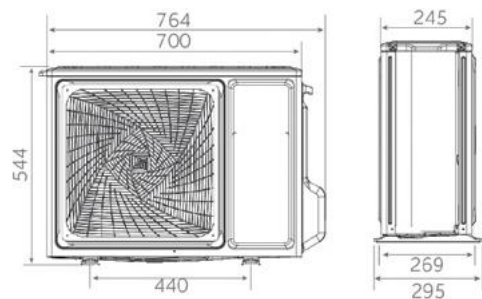

1U50

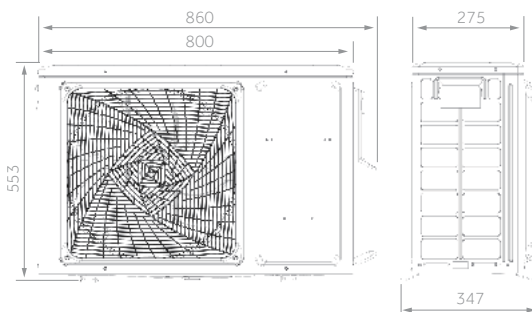

1U71

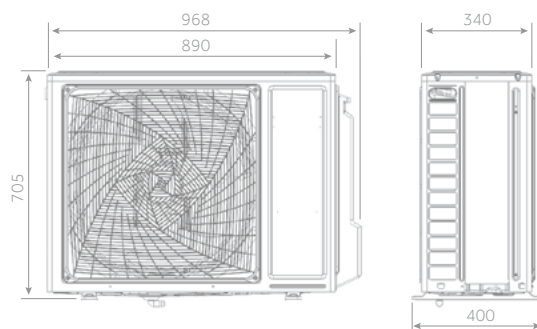

2,5 kW - 3,5 kW

5,0 kW

7,1 kW

PEARL PREMIUM NEW

Haier

MONOSPLIT

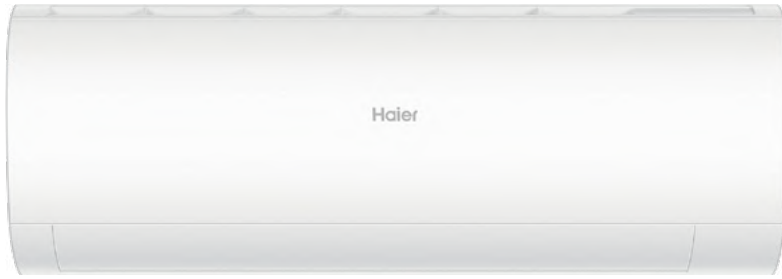

A+++ / A++

2,5 kW

3,5 kW

5,0 kW

7,1 kW



Standard YR-HE2

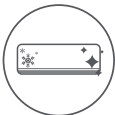

Self Clean



56°C Steri-Clean



UVC Pro



Integrated Wi-Fi Control



Easy Installation



3-Level-Eco



Wi-Fi Easy Pair



I Feel

New features vs PEARL

- Increased energy efficiency to A+++
- Upgraded remote controller to HE2
- I Feel functionality for added comfort
- Wi-Fi quick pair
- 3-Level Eco
- UVC PRO



INDOOR UNIT	Model		AS25PBPHRA-PRE	AS35PBPHRA-PRE	AS50DPHRA-PRE	AS71PEPHRA-PRE
OUTDOOR UNIT	Model		1U25YEPFRA-PRE	1U35MEPFRA-PRE	1U50KEPFRA-PRE	1U71WEPFRA-PRE
Performance data						
Output power - COOLING	nom (min-max)	kW	2,7 (0,8-3,6)	3,6 (0,8-4,0)	5,3 (2,0-6,3)	7,1 (2,1-8,0)
Output power - HEATING	nom (min-max)	kW	3,1 (0,8-4,3)	3,9(0,8-4,5)	5,8 (1,35-6,8)	7,4 (1,5-8,5)
Absorbed power – COOLING	nom (min-max)	kW	0,711 (0,4-1,06)	1,11 (0,4-1,31)	1,51 (0,21-2,2)	1,97 (0,32-2,9)
Absorbed power – HEATING	nom (min-max)	kW	0,835 (0,4-1,39)	1,051 (0,4-1,53)	1,45 (0,5-2,7)	1,95 (0,6-3,2)
Energy class	EER	W/W	3,8	3,23	3,50	3,60
	COP	W/W	3,71	3,71	4,00	3,80
COOLING Pdesign	35 °C	kW	2,7	3,3	5,30	7,10
HEATING Pdesign	(-10 °C)	kW	2,4	2,8	4,60	5,10
Energy class	SEER		8,5 (A+++)	8,5 (A+++)	8,5 (A+++)	8,5 (A+++)
	SCOP		4,6 (A+++)	4,6 (A++)	4,6 (A++)	4,6 (A++)
Annual Energy Consumption - COOLING		kWh/a	111	136	218	292
Annual Energy Consumption - HEATING		kWh/a	730	852	1400	1704
Indoor Unit						
Power supply		Ph/V/Hz	1/220-240/50	1/220-240/50	1/220-240/50	1/220-240/50
Treated air volume	H	m ³ /h	550	640	830	910
Dehumidification		L/h	1,2	1,4	2,3	3,0
High sound power - COOLING		dB	56	60	60	65
High sound power - HEATING		dB	56	60	60	65
Sound pressure - COOLING		dB(A)	37/32/28/18	38/33/29/18	44/40/36/31	48/42/35/27
Sound pressure - HEATING		dB(A)	37/32/28/18	38/33/29/18	44/40/36/31	48/42/35/27
Net dimensions	WxDxH	mm	805x200x292	805x200x292	975x220x318	1105x240x335
Packaging dimensions	WxDxH	mm	876x272x365	876x272x365	1050x397x301	1185x428x331
Net/gross weight		kg	8,1/10,3	8,6/10,8	11,6/14,4	15,4/18,9
Outdoor Unit						
Power supply		Ph/V/Hz	1/220-240/50	1/220-240/50	1/220-240/50	1/220-240/50
Power cable		N x mm ²	3 x 1,0	3 x 1,0	3 x 2,5	3 x 2,5
Interconnection cable		N x mm ²	4 x 1,0	4 x 1,0	4 x 1,0	4 x 1,0
Sound power	H	dB	62	65	65	70
Sound pressure	H	dB(A)	49	51	55	57
Running current cooling/heating	Max	A	4,81/6,31	4,82/6,95	10,0/12,3	13,2/14,5
Starting current cooling/heating	Max	A	1,5/1,5	1,5/1,5	2,0/2,0	2,0/2,0
Net dimensions	WxDxH	mm	700x245x544	800x280x553	820x306x642	890x340x705
Packaging dimensions	WxDxH	mm	819x320x592	902x375x614	940x390x697	1046x460x780
Net/gross weight		kg	24,6/27	28,5/31,4	37,8/40,5	43,0/47,0
Compressor type			Rotary Inverter	Rotary Inverter	Twin rotary inverter	Twin rotary inverter
Installation data						
Refrigerant			R32	R32	R32	R32
Liquid pipe	Ø	mm (inch)	6,35 (1/4)	6,35 (1/4)	6,35 (1/4)	6,35 (1/4)
Gas pipe	Ø	mm (inch)	9,52 (3/8)	9,52 (3/8)	12,7 (1/2)	15,88 (5/8)
Standard pipe length without refrigerant charge		m	5	5	7	7
Maximum pipe length		m	20	20	25	25
Maximum IU - OU elevation		m	10	10	15	15
Refrigerant charge in the factory		kg	0,58	0,65	1,1	1,35
Refrigerant charge in the factory		TCO ₂ eq	0,39	0,44	0,74	0,91
Additional ref, charge over std length		g/m	20	20	20	20
Operating limits - COOLING (in/out)	min-max	°C	21-35/-20-43			
Operating limits - HEATING (in/out)	min-max	°C	10-27/-20-24			

The data in this catalogue is purely indicative as the data may vary. Please be advised to check the accuracy of the data with the supplier before purchasing products.

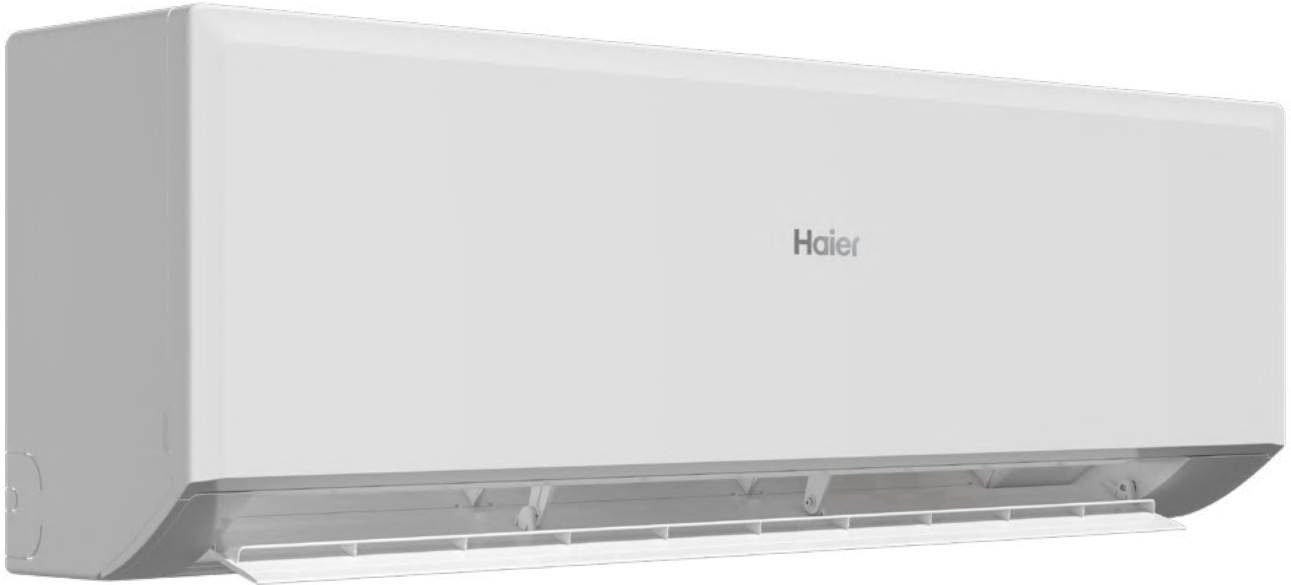

AS25 - AS35

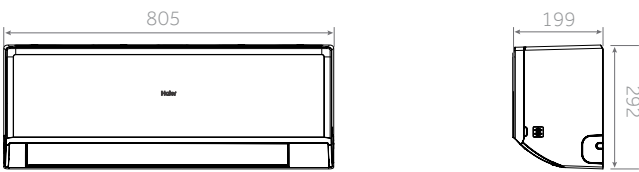

AS50

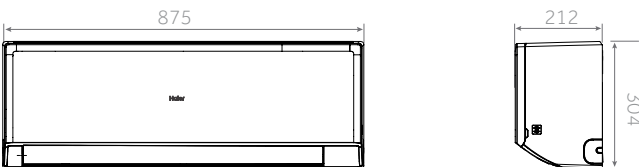

AS68

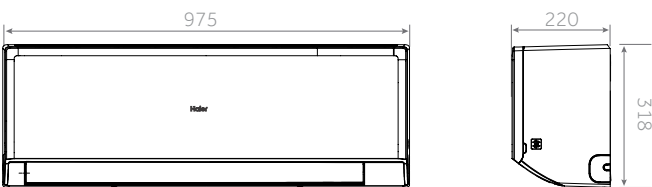

1U25 - 1U35

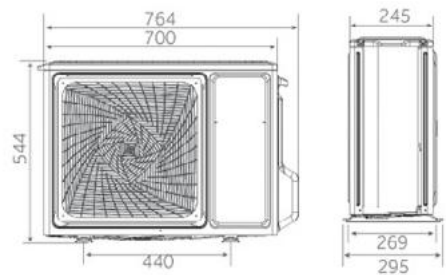

1U50 - 1U68

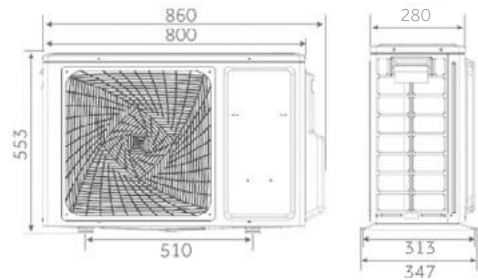

2,5 kW - 3,5 kW

5,0 kW - 6,8 kW

REVIVE PLUS NEW

Estimated Launch Date June 2024

Haier

MONOSPLIT



A++ / A+

2,7 kW

3,5 kW

4,8 kW

6,2 kW



Standard YR-HE2



Coanda Plus



Self Clean



Integrated Wi-Fi Control



Easy Installation



56°C Steri-Clean



3-Level-Eco



Wi-Fi Easy Pair



I Feel

New features vs Revive

- Outdoor power supply
- Indoor works with multi
- Room card
- Increased efficiency
- Upgraded controller to HE2
- I Feel functionality for added comfort
- Wi-Fi quick pair
- 3-Level Eco

INDOOR UNIT	Model	AS25RBAHRA-3	AS35RBAHRA-4	AS50RCBHRA-4	AS68RDAHRA-4	
OUTDOOR UNIT	Model	1U25YEGFRA-3	1U35YESFRA-4	1U50MERFRA-4	1U68MRAFRA-4	
Performance data						
Output power - COOLING	nom (min-max) kW	2,7 (0,7-3,4)	3,2 (0,8-3,8)	4,8 (1,3-5,4)	6,2 (1,3-7,4)	
Output power - HEATING	nom (min-max) kW	2,9 (0,7-3,6)	3,9 (0,7-4,0)	4,8 (1,3-5,4)	6,3 (1,4-7,5)	
Absorbed power - COOLING	nom (min-max) kW	0,84 (0,3-1,1)	1,19 (0,3-1,3)	1,7 (0,4-1,9)	2,0 (0,4-2,2)	
Absorbed power - HEATING	nom (min-max) kW	0,78 (2,3-1,2)	1,42 (0,4-1,6)	1,33 (0,4-1,9)	1,75 (0,6-2,3)	
Energy class	EER	W/W	3,23	2,94	2,81	3,1
	COP	W/W	3,71	2,74	3,6	3,61
COOLING Pdesign	35 °C	kW	2,7	3,2	4,8	6,2
HEATING Pdesign	(-10 °C)	kW	2,6	3,0	3,6	4,6
Energy class	SEER		6,5 (A++)	6,1 (A++)	6,3 (A++)	6,7 (A++)
	SCOP		4 (A+)	4,0 (A+)	4 (A+)	4 (A+)
Annual Energy Consumption - COOLING		kWh/a	145	184	267	324
Annual Energy Consumption - HEATING		kWh/a	910	1050	1260	1610
Indoor Unit						
Power supply		Ph/V/Hz	1/220-240/50	1/220-240/50	1/220-240/50	1/220-240/50
Treated air volume	H	m ³ /h	610/550	620	770/810	1100/1000
Dehumidification		L/h	1,2	1,2	2	2,8
High sound power - COOLING		dB	54	59	60	64
High sound power - HEATING		dB	54	59	60	64
Sound pressure - COOLING		dB(A)	37/32/28/18	38/33/29/18	44/40/35/28	47/45/37/29
Sound pressure - HEATING		dB(A)	37/32/28/18	38/33/29/18	44/40/35/28	47/45/37/29
Net dimensions	WxDxH	mm	805x199x292	805x199x292	875x212x304	975x222x318
Packaging dimensions	WxDxH	mm	876x365x272	876x272x365	945x390x296	1050x397x301
Net/gross weight		kg	8,8/10,5	8,8/10,9	10,0/12,0	11,6/14,4
Outdoor Unit						
Power supply		Ph/V/Hz	1PH/220-240/50	1PH/220-240/50	1PH/220-240/50	1PH/220-240/50
Power Cable		N x mm ²	3 x 1,0	3 x 1,0	3 x 2,5	3 x 2,5
Interconnection cable		N x mm ²	4 x 1,0	4 x 1,0	4 x 1,0	4 x 1,0
Sound power	H	dB	63	64	65	68
Sound pressure	H	dB(A)	49	51	54	57
Running current cooling/heating	Max	A	5,3/6,4	5,6/7,3	8,6	10/10,5
Starting current cooling/heating	Max	A	1,5/1,5	1,5/1,5	2,0/2,0	2,0/2,0
Net dimensions	WxDxH	mm	700x245x544	700x245x544	800x275x553	800x275x553
Packaging dimensions	WxDxH	mm	819x320x592	819x320x592	902x375x607	902x375x607
Net/gross weight		kg	23,6/26	22,0/24,6	29,2/32,1	32,7/36,5
Compressor type			Rotary inverter	Rotary Inverter	Rotary Inverter	Twin rotary inverter
Installation data						
Refrigerant			R32	R32	R32	R32
Liquid pipe	∅	mm (inch)	6,35 (1/4)	6,35 (1/4)	6,35 (1/4)	6,35 (1/4)
Gas pipe	∅	mm (inch)	9,52 (3/8)	9,52 (3/8)	12,70 (1/2)	12,70 (1/2)
Standard pipe length without refrigerant charge		m	5	5	7	7
Maximum pipe length		m	20	20	20	25
Maximum IU - OU elevation		m	10	10	15	15
Refrigerant charge in the factory		kg	510	0,51	780	900
Refrigerant charge in the factory		TCO ₂ eq	0,34	0,34	0,53	0,61
Additional ref, charge over std length		g/m	20	20	20	20
Operating limits - COOLING (in/out)	min-max	°C	21-35/-20-43			
Operating limits - HEATING (in/out)	min-max	°C	10-27/-20-24			

The data in this catalogue is purely indicative as the data may vary. Please be advised to check the accuracy of the data with the supplier before purchasing products.

EXPERT NORDIC



AS25 - AS35

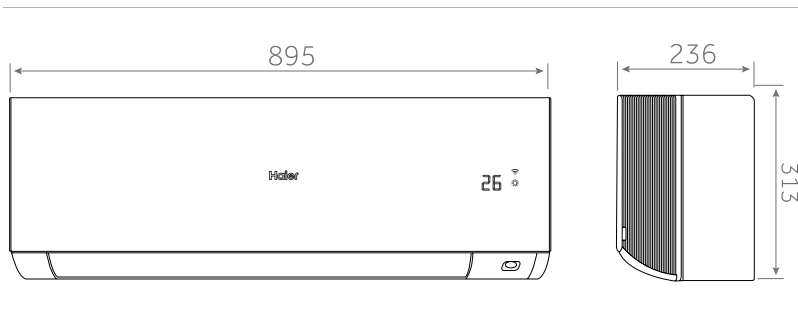

1U25 - 1U35

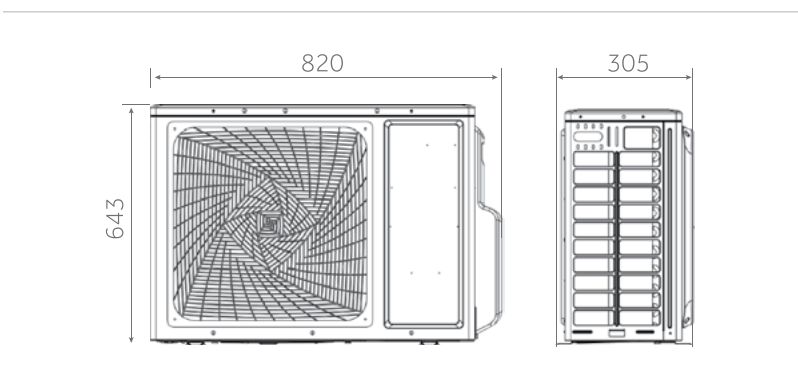

2,5 kW - 3.5kW

EXPERT NORDIC

Haier

2,5 kW

3,5 kW



A+++ / A+++



Standard HQ-HJ



- I Feel
- Self-Clean
- Eco Sensor
- Integrated Wi-Fi control
- Easy to Clean
- UVC Pro
- -30°C Heating
- Freeze-Prevention Technology
- Compressor preheating technology

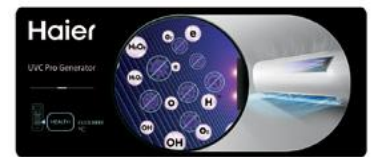

INDOOR UNIT	Model		AS25XCHHRA-NR	AS35XCHHRA-NR
OUTDOOR UNIT	Model		1U25KEHFRA-NR	1U35KEHFRA-NR
Performance data				
Output power - COOLING	nom (min-max)	kW	2,6 (1,00-3,50)	3,5 (1,00-4,40)
Output power - HEATING	nom (min-max)	kW	3,20 (1,00-7,40)	4,20 (1,30-7,90)
Absorbed power - COOLING	nom (min-max)	kW	0,577 (0,30-1,14)	0,823 (0,40-1,21)
Absorbed power - HEATING	nom (min-max)	kW	0,761 (0,40-2,40)	1,000 (0,40-2,40)
Energy class	EER	W/W	4,50	4,25
	COP	W/W	4,50	4,25
COOLING Pdesign	35 °C	kW	2,60	3,50
HEATING Pdesign	(-10 °C)	kW	3,00	3,60
Energy class	SEER		8,50 (A+++)	8,50 (A+++)
	SCOP		5,10 (A+++)	5,10 (A+++)
Annual Energy Consumption - COOLING		kWh/a	107	144
Annual Energy Consumption - HEATING		kWh/a	824	988
Indoor Unit				
Power supply		Ph/V/Hz	1/230/50	1/230/50
Treated air volume	H	m ³ /h	750	810
Dehumidification		L/h	1,2	1,6
High sound power - COOLING		dB	55	56
High sound power - HEATING		dB	55	56
Sound pressure - COOLING		dB(A)	42/32/24/18	43/33/24/18
Sound pressure -HEATING		dB(A)	42/32/24/18	43/33/24/18
Net dimensions	WxDxH	mm	895x236x313	895x236x313
Packaging dimensions	WxDxH	mm	964x386x316	964x386x316
Net/gross weight		kg	12,4/14,8	12,4/14,8
Outdoor Unit				
Power supply		Ph/V/Hz	1/230/50	1/230/50
Power cable		N x mm ²	3 x 1,5	3 x 1,5
Interconnection cable		N x mm ²	4 x 1,0	4 x 1,0
Sound power	H	dB	62	63
Sound pressure	H	dB(A)	55	56
Running current cooling/heating	Max	A	10,9/10,9	11,36/11,36
Starting current cooling/heating	Max	A	1,5/1,5	1,5/1,5
Net dimensions	WxDxH	mm	820x305x643	820x305x643
Packaging dimensions	WxDxH	mm	940x390x697	940x390x697
Net/gross weight		kg	35,7/38,5	35,7/38,5
Compressor type			Rotary Inverter	Rotary Inverter
Installation data				
Refrigerant			R32	R32
Liquid pipe	∅	mm (inch)	6,35 (1/4)	6,35 (1/4)
Gas pipe	∅	mm (inch)	9,52 (3/8)	9,52 (3/8)
Standard pipe length without refrigerant charge		m	7	7
Maximum pipe length		m	20	20
Maximum IU - OU elevation		m	10	10
Refrigerant charge in the factory		kg	1,1	1,1
Refrigerant charge in the factory		TCO ₂ eq	0,743	0,743
Additional ref. charge over std length		g/m	20	20
Operating limits - COOLING (in/out)	min-max	°C	21-35/-20-43	
Operating limits - HEATING (in/out)	min-max	°C	10-27/-30-24	

The data in this catalogue is purely indicative as the data may vary. Please be advised to check the accuracy of the data with the supplier before purchasing products.



AS25 - AS35

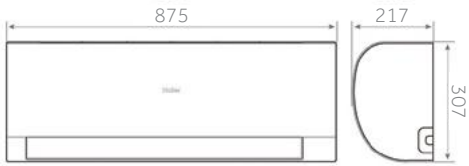

AS50



1U25 - 1U35

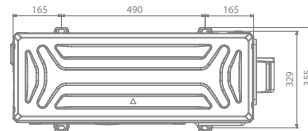
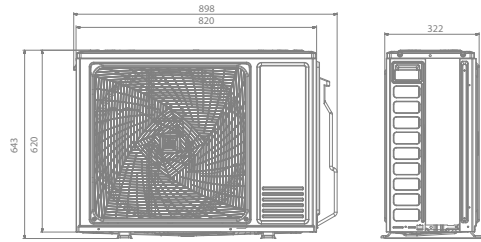

1U50

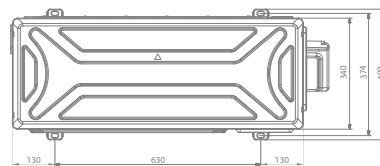
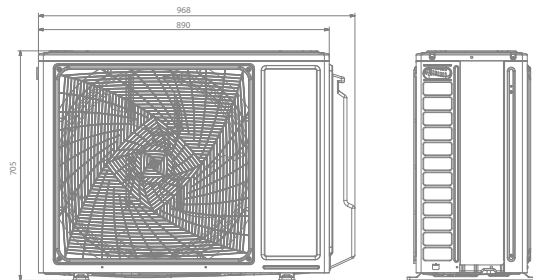

2,5 kW - 3.5kW

5,0 kW

PEARL NORDIC NEW

Estimated Launch Date September 2024

Haier

MONOSPLIT

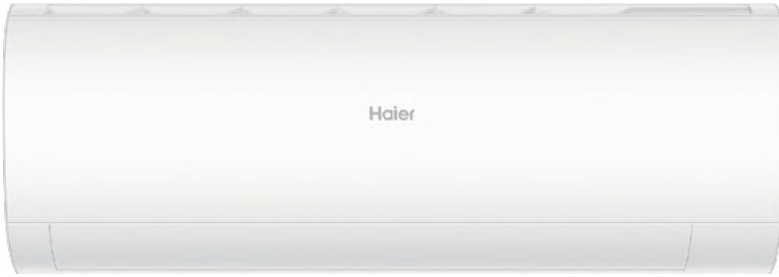

A++ / A++

2,5 kW

3,5 kW

5,0 kW



Standard YR-HE2



Self Clean



56°C Steri-Clean



UVC Pro



Integrated Wi-Fi Control



Easy Installation



-30°C Heating



Freeze Prevention



Compressor Preheating

- Self-Clean
- 56°C Steri-Clean
- UVC Pro
- Integrated Wi-Fi control
- Easy installation
- -30°C Heating
- Freeze-Prevention Technology
- Compressor preheating technology



INDOOR UNIT	Model		AS25PCHHRA-NR	AS35PCHHRA-NR	AS50PDHRA-NR
OUTDOOR UNIT	Model		1U25KEFFRA-NR	1U35KEFFRA-NR	1U50WEFFRA-NR
Performance data					
Output power - COOLING	nom (min-max)	kW	2,6 (0,8-3,9)	3,5 (1,0-4,5)	5,2 (1,4-7,00)
Output power - HEATING	nom (min-max)	kW	3,6 (0,8-6,4)	4,2 (1,0-7,4)	6,0 (1,5-8,3)
Absorbed power – COOLING	nom (min-max)	kW	0,6 (0,23-1,25)	0,86 (0,32-1,35)	1,39 (0,4-1,85)
Absorbed power – HEATING	nom (min-max)	kW	0,79 (0,3-2,2)	0,93 (0,3-2,4)	1,40 (0,5-3,0)
Energy class	EER	W/W	4,30	4,10	3,73
	COP	W/W	4,50	4,50	4,23
COOLING Pdesign	35 °C	kW	2,60	3,50	5,20
HEATING Pdesign	(-10 °C)	kW	3,60	4,20	6,00
Energy class	SEER		7,8 (A++)	7,7 (A++)	7,5 (A++)
	SCOP		4,6 (A++)	4,6 (A++)	4,6 (A++)
Annual Energy Consumption - COOLING		kWh/a	117	159	242
Annual Energy Consumption - HEATING		kWh/a	913	1187	1400
Indoor Unit					
Power supply		Ph/V/Hz	1/220-240/50	1/220-240/50	1/220-240/50
Treated air volume	H	m3/h	620/615	680/660	800/830
Dehumidification		L/h	1,0	1,2	2,3
High sound power - COOLING		dB	55	56	58
High sound power - HEATING		dB	55	56	58
Sound pressure - COOLING		dB(A)	38/33/26/18	40/34/29/19	42/39/36/30
Sound pressure - HEATING		dB(A)	38/33/26/18	40/34/29/19	42/39/36/30
Net dimensions	WxDxH	mm	875x217x307	875x217x307	975x220x318
Packaging dimensions	WxDxH	mm	945x390x296	945x390x296	1050x397x301
Net/gross weight		kg	10,0/12,0	10,0/12,0	11,6/14,4
Outdoor Unit					
Power supply		Ph/V/Hz	1/220-240/50	1/220-240/50	1/220-240/50
Power cable		N x mm2	3 x 1,5	3 x 1,5	3 x 2,5
Interconnection cable		N x mm2	4 x 1,0	4 x 1,0	4 x 1,0
Sound power	H	dB	62	63	63
Sound pressure	H	dB(A)	55	56	57
Running current cooling/heating	Max	A	5,7/9,5	6,1/10,5	8,5/14,0
Starting current cooling/heating	Max	A	1,5/1,5	1,5/1,5	2,0/2,0
Net dimensions	WxDxH	mm	820x306x642	820x306x642	890x340x705
Packaging dimensions	WxDxH	mm	940x390x697	940x390x697	1046x460x780
Net/gross weight		kg	37,8/40,5	37,8/40,5	43,0/47,0
Compressor type			Twin rotary inverter	Twin rotary inverter	Twin rotary inverter
Installation data					
Refrigerant			R32	R32	R32
Liquid pipe	Ø	mm (inch)	6,35(1/4)	6,35(1/4)	6,35(1/4)
Gas pipe	Ø	mm (inch)	9,52(3/8)	9,52(3/8)	12,7(1/2)
Standard pipe length without refrigerant charge		m	7	7	7
Maximum pipe length		m	20	20	25
Maximum IU - OU elevation		m	15	15	15
Refrigerant charge in the factory		kg	1,1	1,1	1,2
Refrigerant charge in the factory		TCO2eq	0,74	0,74	0,81
Additional ref, charge over std length		g/m	20	20	20
Operating limits - COOLING (in/out)	min-max	°C		21-35/-15-43	
Operating limits - HEATING (in/out)	min-max	°C		10-27/-30-24	

The data in this catalogue is purely indicative as the data may vary. Please be advised to check the accuracy of the data with the supplier before purchasing products.

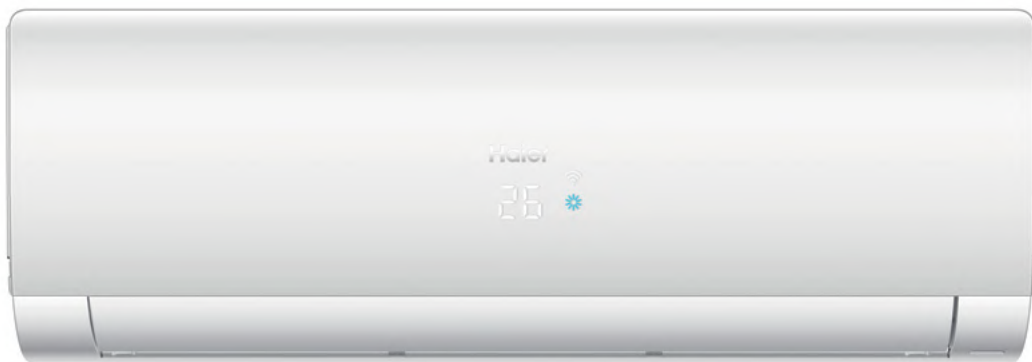

AS105S2SF2FA-2



1U105S2SF2FA

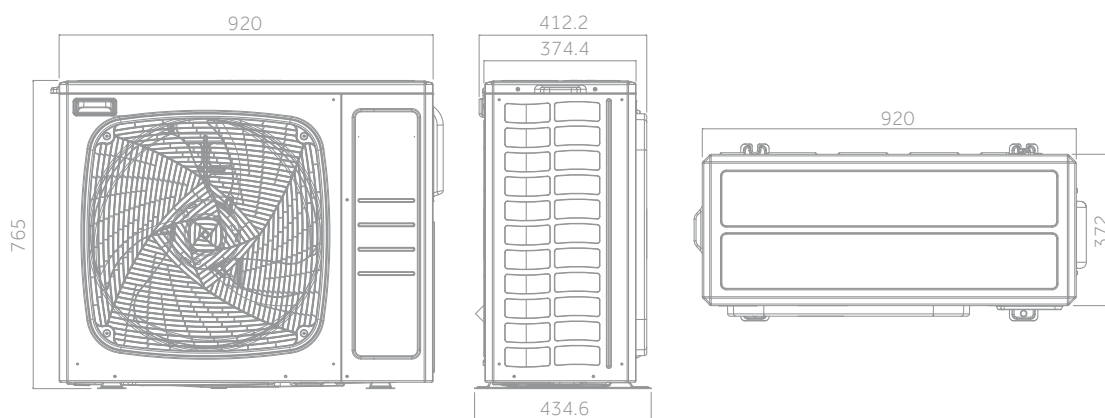

10,5 kW



A++ / A+



Standard YR-HE



Nano-Aqua Sterilisation



Easy Installation



Silence



Sleep

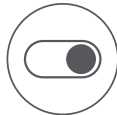

On-Off Card



3D

- Nano-Aqua Sterilisation
- Easy installation
- Low noise level
- Comfortable Sleep
- On-Off Card
- 3D airflow: continuous movement of horizontal and vertical deflectors
- 2-Way Pipe Design

INDOOR UNIT	Model	AS105S2SF2FA-2	
OUTDOOR UNIT	Model	1U105S2SF2FA	
Performance data			
Output power - COOLING	nom (min-max)	kW	9,00 (2,50-10,00)
Output power - HEATING	nom (min-max)	kW	9,50 (3,00-10,50)
Absorbed power - COOLING	nom (min-max)	kW	3,00 (0,80-3,70)
Absorbed power - HEATING	nom (min-max)	kW	2,56 (0,80-4,00)
Energy class	EER	W/W	3,00
	COP	W/W	3,71
COOLING Pdesign	35 °C	kW	9,00
HEATING Pdesign	(-10 °C)	kW	7,20
Energy class	SEER		6,10 (A++)
	SCOP		4,00 (A+)
Annual Energy Consumption - COOLING		kWh/a	516
Annual Energy Consumption - HEATING		kWh/a	2518
Indoor Unit			
Power supply		Ph/V/Hz	1/220-240/50/60
Treated air volume	Max	m ³ /h	1300
High sound power		dB	65
Sound pressure		dB(A)	48/44/40/36
Net dimensions	WxDxH	mm	1342x275x365
Packaging dimensions	WxDxH	mm	1418x402x478
Net/gross weight		kg	21,0/25,5
Outdoor Unit			
Power supply		Ph/V/Hz	1/220-240/50
Power cable		N x mm ²	3 x 4,0
Interconnection cable		N x mm ²	4 x 2,5
Sound power	H	dB	70
Sound pressure	H	dB(A)	60
Running current cooling/heating	Max	A	16,5
Starting current cooling/heating	Max	A	2,0
Compressor type			Twin rotary inverter
Net dimensions	WxDxH	mm	920x372x765
Packaging dimensions	WxDxH	mm	1050x485x1130
Net/gross weight		kg	85,0/90,0
Compressor type			Twin rotary inverter
Installation data			
Refrigerant			R32
Liquid pipe	∅	mm (inch)	9,52 (3/8)
Gas pipe	∅	mm (inch)	15,88 (5/8)
Standard pipe length without refrigerant charge		m	7
Maximum pipe length		m	50
Maximum IU - OU elevation		m	30
Refrigerant charge in the factory		kg	1,70
Refrigerant charge in the factory		TCO ₂ eq	1,15
Additional ref. charge over std length		g/m	45
Outdoor operating limits - COOLING	min-max	°C	-20-43
Outdoor operating limits - HEATING	min-max	°C	-20-24



MATT DESIGN: OPAQUE

AF25 - AF35 - AF42 - AF50

1U25 - 1U35 - 1U42

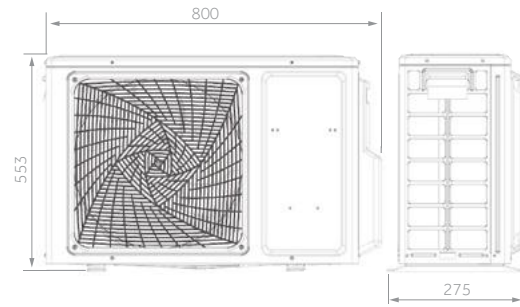
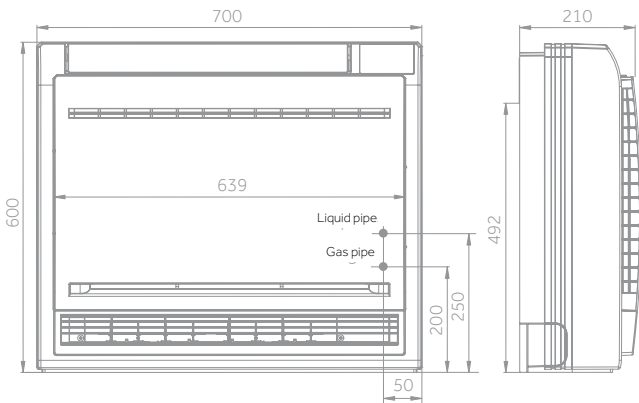

1U50

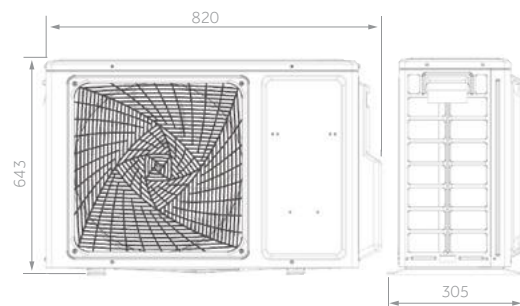

MOUNTING DIMENSIONS

MOUNTING DIMENSIONS

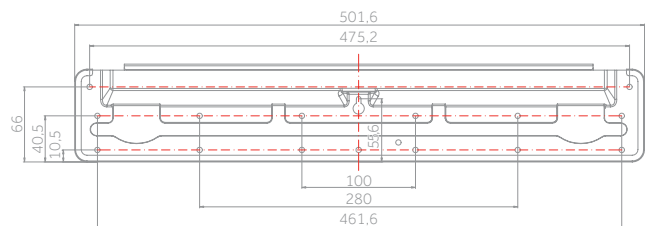
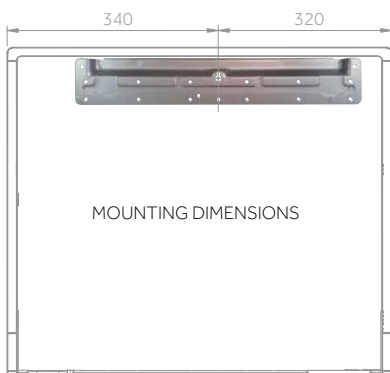

2,5 kW - 4,2 kW



5,0 kW

CONSOLE NEW

Haier

MONOSPLIT



A++ / A+

2,5 kW

3,5 kW

4,2 kW

5,0 kW



Standard YR-HQS01



Silence



Double Flow

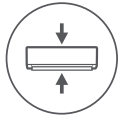

Compact Design



Sleep



Integrated Wi-Fi Control



56°C Steri-Clean



R32 Detector



Heating Cable w/Nordic ver

- Low noise level
- Double airflow
- Compact design
- Sleep function for greater night time comfort
- Integrated Wi-Fi control
- 56°C Steri-Clean
- R32 Detector

While Stocks Last

INDOOR UNIT	Model	AF25S2SD1FA(D)	AF35S2SD1FA(D)	AF42S2SD1FA(D)	AF50S2SD1FA(D)	
OUTDOOR UNIT STANDARD	Model	1U25S2SM1FA-2	1U35S2SM1FA-2	1U42S2SM1FA	1U50S2S2FA-2	
OUTDOOR UNIT NORDIC	Model	1U25MEHFRA-1	1U35MEHFRA-1	-	-	
Performance data						
Output power - COOLING	nom (min-max) kW	2,50 (0,80-3,20)	3,40 (1,00-4,00)	4,20 (1,40-4,50)	5,0 (1,80-5,20)	
Output power - HEATING	nom (min-max) kW	3,00 (0,80-3,80)	3,50 (1,00-4,50)	4,70 (1,40-5,00)	5,40 (1,80-5,60)	
Absorbed power - COOLING	nom (min-max) kW	0,65 (0,20-1,30)	0,94 (0,30-1,50)	1,30 (0,50-1,60)	1,59 (0,70-1,70)	
Absorbed power - HEATING	nom (min-max) kW	0,80 (0,30-1,60)	0,94 (0,50-1,60)	1,50 (0,60-1,90)	1,67 (0,70-2,10)	
Energy class	EER	3,80	3,60	3,23	3,23	
	COP	3,73	3,73	3,11	3,24	
COOLING Pdesign	35 °C kW	2,50	3,40	4,20	5,00	
HEATING Pdesign	(-10 °C) kW	2,40	2,90	3,20	3,40	
Energy class	SEER	8,00 (A++)	7,50 (A++)	7,00 (A++)	6,30 (A++)	
	SCOP	4,20 (A+)	4,20 (A+)	4,00 (A+)	4,05 (A+)	
Annual Energy Consumption - COOLING	kWh/a	107	157	208	278	
Annual Energy Consumption - HEATING	kWh/a	798	962	1115	1392	
Indoor Unit						
Power supply		Ph/V/Hz	1/220-240/50/60	1/220-240/50/60	1/220-240/50/60	1/220-240/50/60
Treated air volume	(H/M/L/Q)	m3/h	450/400/350/300/250	500/450/400/350/300	580/530/480/430/380	600/550/500/450/400
High sound power		dB	52	55	58	61
Sound pressure		dB(A)	40/32/25/20	42/34/26/21	46/37/33/28	50/42/37/32
Net dimensions	WxDxH	mm	700x210x600	700x210x600	700x210x600	700x210x600
Packaging dimensions	WxDxH	mm	783x303x695	783x303x695	783x303x695	783x303x695
Net/gross weight		kg	16,5/18,5	16,5/18,5	16,5/18,5	16,5/18,5
Outdoor Unit						
Power supply		Ph/V/Hz	1/220-240/50	1/220-240/50	1/220-240/50	1/220-240/50
Power cable		N x mm2	3 x 1,5	3 x 1,5	3 x 1,5	3 x 2,5
Interconnection cable		N x mm2	4 x 1,0	4 x 1,0	4 x 1,0	4 x 1,0
Sound power	H	dB	59	61	63	67
Sound pressure	H	dB(A)	47	48	50	53
Running current cooling/heating	Max	A	8,0	9,5	8,0	13
Starting current cooling/heating	Max	A	2,0	2,0	2,0	2,0
Net dimensions	WxDxH	mm	800x275x553	800x275x553	800x275x553	820x305x643
Packaging dimensions	WxDxH	mm	902x375x607	902x375x607	902x375x607	940x390x697
Net/gross weight		kg	27,6/30,4	30,0/32,9	31,5/34,0	35,7/38,5
Compressor type			Rotary inverter	Rotary inverter	Rotary inverter	Rotary inverter
Installation data						
Refrigerant			R32	R32	R32	R32
Liquid pipe	Ø	mm (inch)	6,35 (1/4)	6,35 (1/4)	6,35 (1/4)	6,35 (1/4)
Gas pipe	Ø	mm (inch)	9,52 (3/8)	9,52 (3/8)	9,52 (3/8)	12,70 (3/8)
Standard pipe length without refrigerant charge		m	7	7	7	7
Maximum pipe length		m	20	20	20	25
Maximum IU - OU elevation		m	10	10	10	15
Refrigerant charge in the factory		kg	0,63	0,78	0,94	1,1
Refrigerant charge in the factory		TCO2eq	0,43	0,53	0,63	0,74
Additional ref, charge over std length		g/m	20	20	20	20
Outdoor operating limits - COOLING	min-max	°C			-20-43	
Outdoor operating limits - HEATING	min-max	°C			-20-24	



185MM ULTRA-THIN UNIT

185mm of thickness for easy installation.

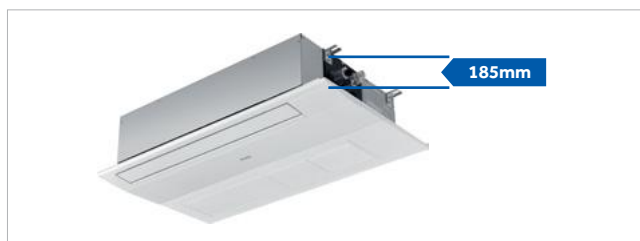

HIGH LIFT-UP DRAIN PUMP

It can lift condensed water up to 600mm, which make installation more flexible according to the layout.

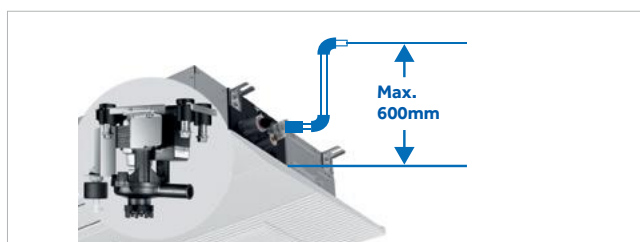

1-WAY CASSETTE ^{NEW}

ANTIBACTERIAL FILTER

With silver ion health filter, its bactericidal rate is as high as 99.9%, mildew grade is 0.



UVC STERILISATION

The built-in UVC Sterilisation module emits short-wave ultraviolet rays near the return air outlet to sterilise the air entering the air conditioner, without harmful chemicals and residues.



WI-FI

Besides normal wired/infrared control, Haier provides smart control with our hOn APP, including the ON/OFF, operation mode selection, fan speed, temperature, air flow adjustment, schedule and UVC function.



ROOM CARD

Allows the use of room cards to control the unit (on and off). Suitable for applications such as hotel.



10° TILT PANEL

10° tilt panel avoids the air blowing directly into people, providing a more even airflow.



NEW 1 WAY CASSETTE



AB25 - AB35 - AB50 - AB71

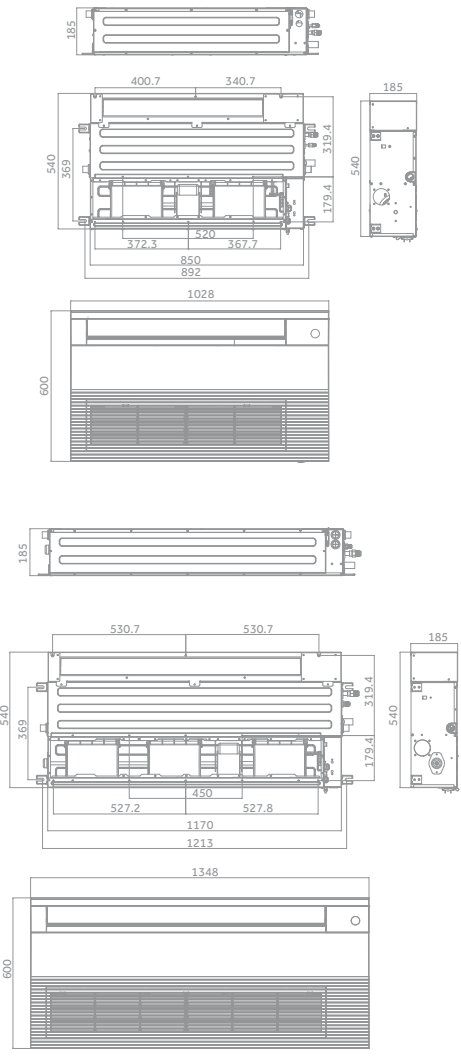

1U25 - 1U35

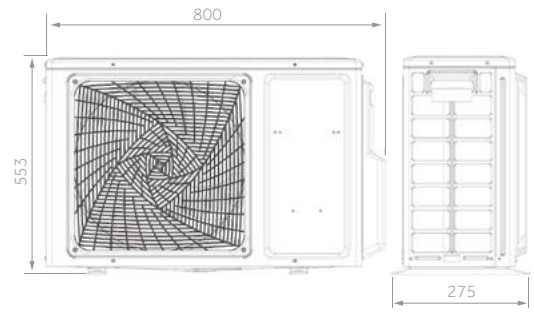

1U50

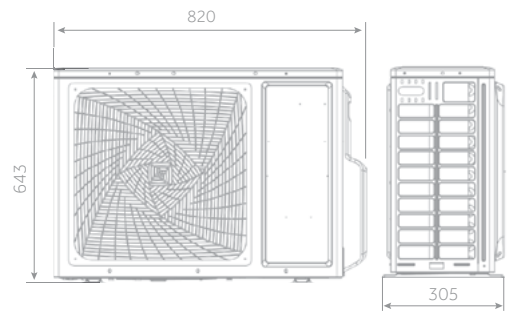

1U71

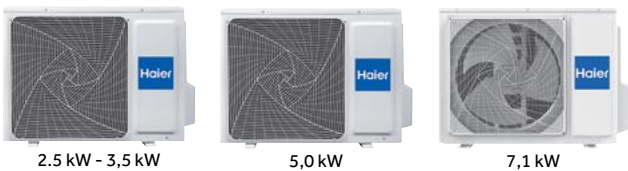
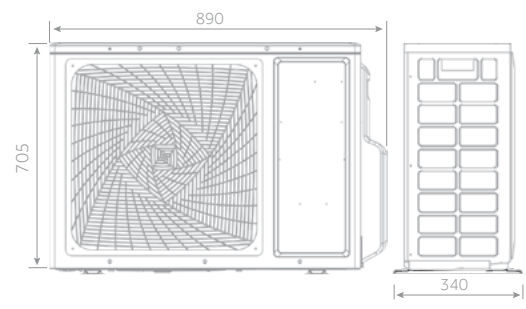

2.5 kW - 3.5 kW

5.0 kW

7.1 kW

1-WAY CASSETTE ^{NEW}

Haier

MONOSPLIT



A++ / A+

2,5 kW

3,5 kW

5,0 kW

7,1 kW

Please see pages 40 & 41
For Controller Options

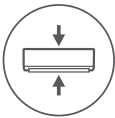

Compact Design



Integrated Wi-Fi Control



UVC Sterilisation



Fresh Air



- Compact Design (185 mm)
- Integrated Wi-Fi control
- UVC Sterilisation
- 'Fresh air' knockout is incorporated in the chassis to allow fresh air introduction

INDOOR UNIT	Model		AB25S2SA1FA(H)	AB35S2SA1FA(H)	AB50S2SA1FA(H)	AB71S2SA1FA(H)
OUTDOOR UNIT	Model		1U25S2SM1FA-2	1U35S2SM1FA-2	1U50S2SJ2FA-2	1U71S2ST1FA
Performance data						
Output power - COOLING	nom (min-max)	kW	2,6 (0,7-4,3)	3,5 (1,0-4,3)	5,0 (1,8-5,8)	6,9 (2-7,3)
Output power - HEATING	nom (min-max)	kW	3,2 (0,9-4,6)	4,0 (1,0-5,3)	5,5 (2-6,5)	7,6 (2,5-8)
Absorbed power - COOLING	nom (min-max)	kW	0,78 (0,25-1,6)	1,06 (0,3-1,5)	1,53 (0,55-2)	2,14 (0,5-2,6)
Absorbed power - HEATING	nom (min-max)	kW	0,86 (0,25-1,6)	1,08 (0,5-1,6)	1,48 (0,7-2,1)	2,04 (0,5-2,6)
Energy class	EER	W/W	3,31	3,31	3,26	3,23
	COP	W/W	3,72	3,72	3,72	3,72
COOLING Pdesign	35 °C	kW	2,6	3,5	5	6,9
HEATING Pdesign	(-10 °C)	kW	2,1	3	4	5
Energy class	SEER		6,2 (A++)	6,2 (A++)	6,2 (A++)	6,1 (A++)
	SCOP		4,0 (A+)	4,2 (A+)	4,0 (A+)	4,0 (A+)
Annual Energy Consumption - COOLING		kWh/a	210	199	363	406
Annual Energy Consumption - HEATING		kWh/a	1398	1020	1932	1831
Indoor Unit						
Power supply		Ph/V/Hz	1/220-240/50/60	1/220-240/50/60	1/220-240/50/60	1/220-240/50/60
Treated air volume	(H/M/L/Q)	m3/h	500/450/400/350	560/500/450/400	850/700/550/450	900/700/600/500
High sound power		dB	62	64	65	67
Sound pressure		dB(A)	43/40/37/34	45/42/39/36	47/44/41/38	49/46/43/40
Net dimensions	WxDxH	mm	850x540x185	850x540x185	1170x540x185	1170x540x185
Packaging dimensions	WxDxH	mm	1043x648x270	1043x648x270	1363x648x270	1363x648x270
Net/gross weight		kg	20,8/24,9	20,8/24,9	26/31	27/32
Panel	Model		P1B-1028IB	P1B-1028IB	P1B-1348IB	P1B-1348IB
Panel Net dimensions	WxDxH	mm	1028x600x45	1028x600x45	1348x600x45	1348x600x45
Panel Packaging dimensions	WxDxH	mm	1143x688x170	1143x688x170	1463x688x170	1463x688x170
Panel Net/gross weight			3,9/8,0	3,9/8,0	5,1/9,8	5,1/9,8
Outdoor Unit						
Power supply		Ph/V/Hz	1/220-240/50	1/220-240/50	1/220-240/50	1/220-240/50/60
Power cable		N x mm2	3 x 1,5	3 x 1,5	3 x 1,5	3 x 4,0
Interconnection cable		N x mm2	4 x 1,0	4 x 1,0	4 x 1,0	4 x 2,5
Sound power	H	dB	59	61	63	68
Sound pressure	H	dB(A)	47	48	50	54
Running current cooling/heating	Max	A	8,0	8,0	10,68	13,1
Starting current cooling/heating	Max	A	2,0	2,0	2,0	2,0
Net dimensions	WxDxH	mm	800x275x553	800x275x553	820x305x643	890x340x705
Packaging dimensions	WxDxH	mm	902x375x607	902x375x607	940x390x697	1046x460x780
Net/gross weight		kg	27,6/30,4	30/32,9	35,7/38,5	44/48
Compressor type			Rotary	Rotary	Rotary	Twin rotary
Installation data						
Refrigerant			R32	R32	R32	R32
Liquid pipe	Ø	mm (inch)	6,35 (1/4)	6,35 (1/4)	6,35 (1/4)	9,52 (3/8)
Gas pipe	Ø	mm (inch)	9,52 (3/8)	9,52 (3/8)	12,70 (1/2)	15,88 (5/8)
Standard pipe length without refrigerant charge		m	7	7	7	10
Maximum pipe length		m	20	20	25	50
Maximum IU - OU elevation		m	10	10	15	30
Refrigerant charge in the factory		kg	0,63	0,78	1,1	1,23
Refrigerant charge in the factory		TCO2eq	1,1	0,53	0,74	0,83
Additional ref, charge over std length		g/m	20	20	20	45
Outdoor operating limits - COOLING	min-max	°C	-20-43			
Outdoor operating limits - HEATING	min-max	°C	-20-24			

CASSETTE 620



AB25 - AB35 - AB50

1U25 - 1U35

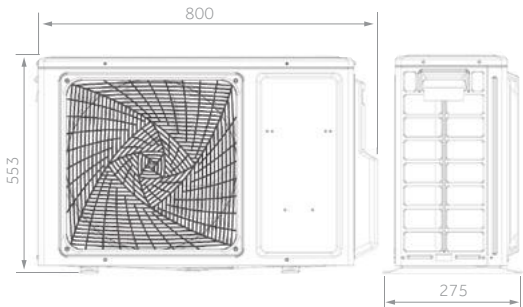
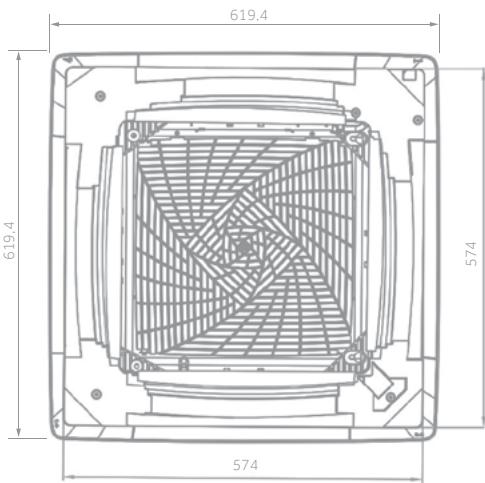

1U50

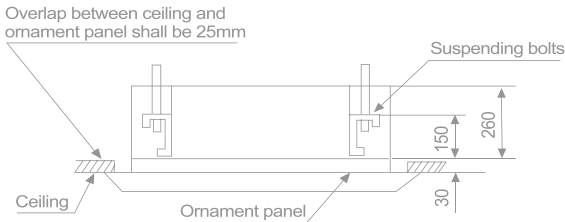
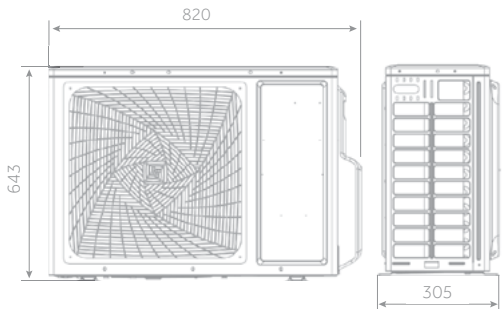

2,5 kW - 3,5 kW



5,0 kW

CASSETTE 620

Haier

2,5 kW

3,5 kW

5,0 kW

Please see pages 40 & 41
For Controller Options

MONOSPLIT



A++ / A



Silence



4 Way Independent



Integrated Wi-Fi Control



UVC Sterilisation



Fresh Air

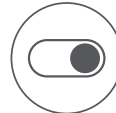

On-Off Card



- Low noise level
- Integrated Wi-Fi control
- 'Fresh air' knockout is incorporated in the chassis to allow fresh air introduction of up to 20% of nominal unit air flow without compromising the cooling capacity.
- On-Off card

INDOOR UNIT	Model		AB25S2SC2FA(H)	AB35S2SC2FA(H)	AB50S2SC2FA(H)
OUTDOOR UNIT	Model		1U25S2SM1FA-2	1U35S2SM1FA-2	1U50S2SJ2FA-2
Performance data					
Output power - COOLING	nom (min-max)	kW	2,5 (0,7-4,3)	3,50 (0,90-4,50)	5,00 (1,80-5,80)
Output power - HEATING	nom (min-max)	kW	3,23 (0,9-4,6)	4,00 (1,00-4,80)	5,50 (2,00-6,50)
Absorbed power - COOLING	nom (min-max)	kW	0,89 (0,25-1,6)	1,06 (0,28-1,80)	1,53 (0,55-2,00)
Absorbed power - HEATING	nom (min-max)	kW	0,87 (0,25-1,6)	1,08 (0,28-1,80)	1,52 (0,60-2,00)
Energy class	EER	W/W	2,8	3,31	3,26
	COP	W/W	3,71	3,71	3,42
COOLING Pdesign	35 °C	kW	2,5	3,50	5,00
HEATING Pdesign	(-10 °C)	kW	2,8	3,00	4,00
Energy class	SEER		6,10 (A++)	6,10 (A++)	6,10 (A++)
	SCOP		4,00 (A+)	3,80 (A)	4,00 (A+)
Annual Energy Consumption - COOLING		kWh/a	210	222	363
Annual Energy Consumption - HEATING		kWh/a	1398	1427	1932
Indoor Unit					
Power supply		Ph/V/Hz	1/220-240/50/60	1/220-240/50/60	1/220-240/50/60
Treated air volume	(H/M/L/Q)	m ³ /h	580/480/380/280	620/520/450/350	700/620/500/400
High sound power		dB	50	52	55
Sound pressure		dB(A)	35/32/28/26	36/33/30/27	42/37/35/32
Net dimensions	WxDxH	mm	570x570x260	570x570x260	570x570x260
Packaging dimensions	WxDxH	mm	718x680x380	718x680x380	718x680x380
Net/gross weight		kg	18,5/22	18,5/22,0	19,0/22,0
Panel	Model		PB-620KB(H)	PB-620KB(H)	PB-620KB(H)
Panel Net dimensions	WxDxH	mm	620x620x60	620x620x60	620x620x60
Panel Packaging dimensions	WxDxH	mm	660x660x115	660x660x115	660x660x115
Panel Net/gross weight			2,8/4,5	2,8/4,5	2,8/4,5
Outdoor Unit					
Power supply		Ph/V/Hz	1/220-240/50	1/220-240/50	1/220-240/50
Power cable		N x mm ²	3 x 1,5	3 x 1,5	3 x 1,5
Interconnection cable		N x mm ²	4 x 1,0	4 x 1,0	4 x 1,0
Sound power	H	dB	60	61	63
Sound pressure	H	dB(A)	47	48	50
Running current cooling/heating	Max	A	8,0	8,0	10,68
Starting current cooling/heating	Max	A	2,0	2,0	2,0
Net dimensions	WxDxH	mm	800x275x553	800x275x553	820x305x643
Packaging dimensions	WxDxH	mm	902x375x607	902x375x607	940x390x697
Net/gross weight		kg	27,6/30,4	30,0/32,9	35,7/38,5
Compressor type			Rotary inverter	Rotary inverter	Rotary inverter
Installation data					
Refrigerant			R32	R32	R32
Liquid pipe	∅	mm (inch)	6,35 (1/4)	6,35 (1/4)	6,35 (1/4)
Gas pipe	∅	mm (inch)	9,52 (3/8)	9,52 (3/8)	12,70 (1/2)
Standard pipe length without refrigerant charge		m	7	7	7
Maximum pipe length		m	20	20	25
Maximum IU - OU elevation		m	10	10	15
Refrigerant charge in the factory		kg	0,63	0,78	1,10
Refrigerant charge in the factory		TCO _{2eq}	0,43	0,53	0,74
Additional ref. charge over std length		g/m	20	20	20
Outdoor operating limits - COOLING	min-max	°C		-20-43	
Outdoor operating limits - HEATING	min-max	°C		-20-24	

ROUND FLOW CASSETTE



ROUND FLOW CASSETTE

360-DEGREE FLOW

Thanks to an 8 way flow of air, it is possible to ensure a 360-degree airflow without any blind spots.

NEW DESIGN +23% AIRFLOW

The increased surface area of the new grill ensures a greater distribution of air (+23%) compared to traditional models.



HEALTHY FILTER

Haier antibacterial filter has added silver ions and antibacterial organics to kill Escherichia coli & Staphylococcus aureus effectively, with long lasting effects.

Panel with antibacterial filter is PB-950KB(H) (Optional).



CONDENSATE DRAIN

The Cassette units include the condensation drain pump as standard, which guarantees a maximum prevalence of 1000 mm measured from the base of the machine.

There is the possibility of performing condensate drain by gravity (reversible on both sides).

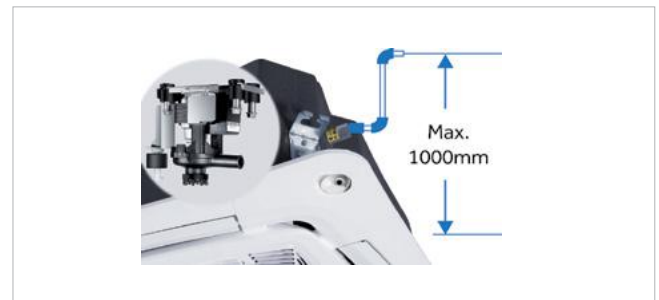

FRESH AIR

Air exchange allows introduction of clean air into the ambient.

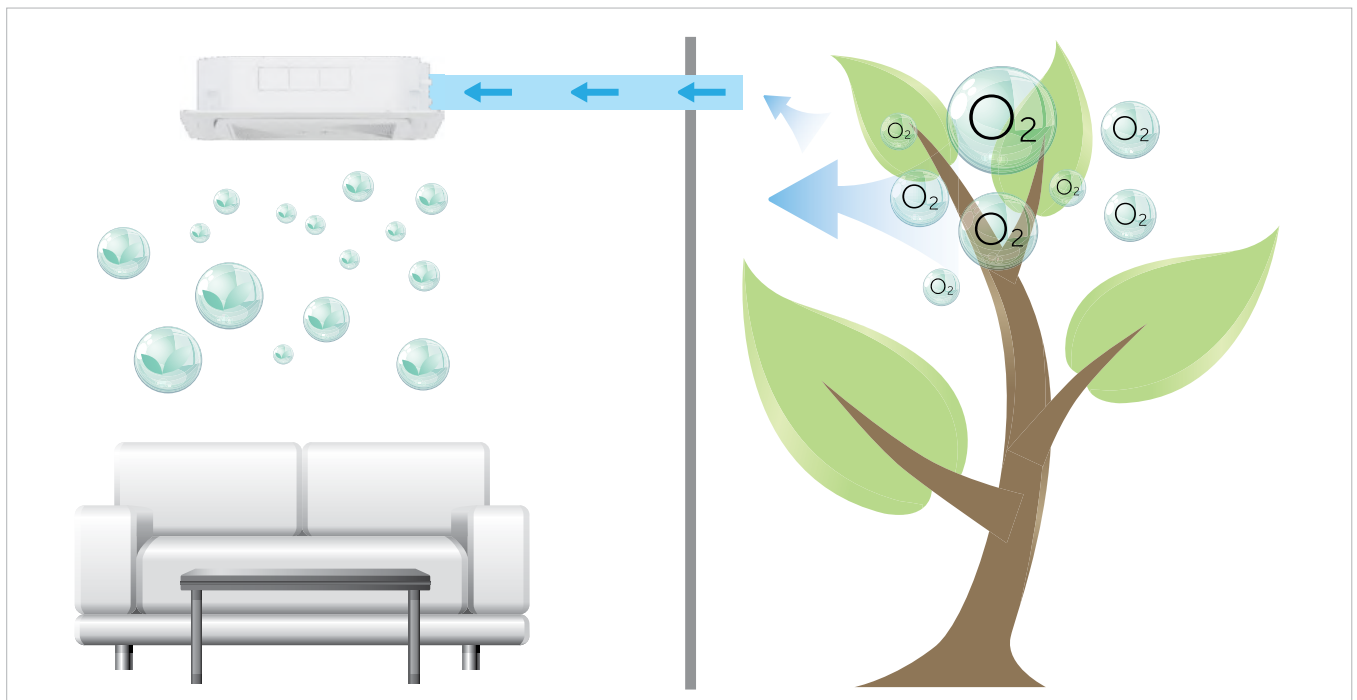

ROUND FLOW CASSETTE



AB71 - ABH105 - ABH125

1U71

1U105

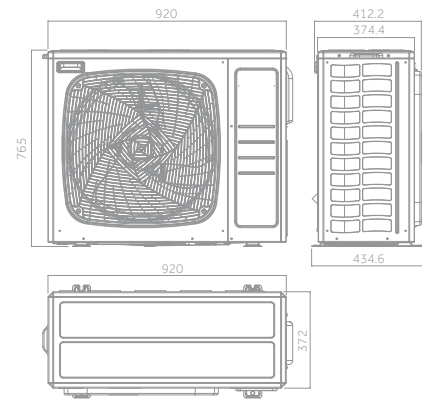
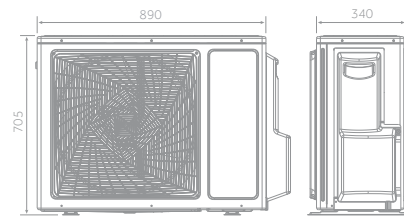
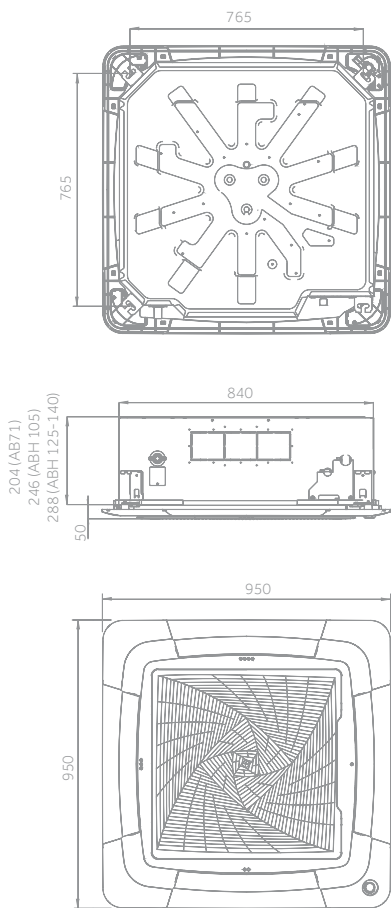

1U125

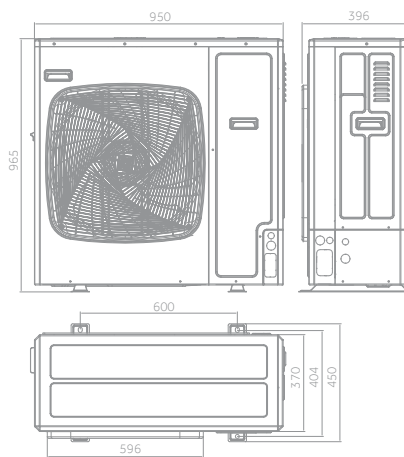

7,1 kW



10,5 kW



12,5 kW

ROUND FLOW CASSETTE



7,1 kW

9,2 kW

12,3 kW

Please see pages 40 & 41
For Controller Options



Silence



8 Way Independent



Fresh Air



Integrated Wi-Fi Control



UVC Sterilisation



- Low noise level
- 'Fresh air' knockout is incorporated in the chassis to allow fresh air introduction of up to 20% of nominal unit air flow without compromising the cooling capacity. More than 20% of the air conditioner's thermal cooling capacity is penalise.
- Integrated Wi-Fi control
- UVC Sterilisation

Indoor Unit	Model		AB71S2SG1FA(H)	ABH105H1ERG(H)	ABH105H1ERG(H)	ABH125K1ERG(H)	ABH125K1ERG(H)
Outdoor Unit	Model		1U71S2ST1FA	1U105S2S2FA	1U105S2SS1FB	1U125S2SN2FA	1U125S2SN2FB
Performance data							
Output power - COOLING	nom (min-max)	kW	7,10 (2,00-7,30)	9,20 (2,50-10,00)	9,20 (2,50-10,00)	12,30 (3,00-13,00)	12,40 (3,00-13,00)
Output power - HEATING	nom (min-max)	kW	7,90 (2,50-8,00)	10,10 (3,00-10,50)	10,50 (3,00-11,00)	12,70 (3,50-13,50)	12,80 (3,50-13,50)
Absorbed power - COOLING	nom (min-max)	kW	2,00 (0,50-2,60)	3,12 (0,50-4,00)	3,25 (0,50-4,00)	4,84 (1,00-6,00)	4,81 (1,00-6,00)
Absorbed power - HEATING	nom (min-max)	kW	2,11 (0,50-2,60)	2,91 (0,50-4,00)	3,10 (0,50-4,00)	4,44 (1,00-6,00)	4,41 (1,00-6,00)
Energy class	EER	W/W	3,55	3,00	3,00	2,54	2,58
	COP	W/W	3,75	3,50	3,50	2,86	2,93
COOLING Pdesign	35 °C	kW	7,10	9,20	9,20	12,30	12,40
HEATING Pdesign	(-10 °C)	kW	5,00	7,20	6,00	8,30	8,30
Energy class	SEER		6,85 (A++)	5,90 (A+)	5,90 (A+)	5,68 (A+)	5,71 (A+)
	SCOP		4,23 (A+)	3,80 (A)	3,91 (A)	3,93 (A)	3,96 (A)
Annual Energy Consumption - COOLING		kWh/a	406	555	555	740	736
Annual Energy Consumption - HEATING		kWh/a	1831	2780	2136	3032	3003
Indoor Unit							
Power supply		Ph/V/Hz	1/220-240/50/60	1/220-240/50/60	1/220-240/50/60	1/220-240/50/60	1/220-240/50/60
Treated air volume	(H/M/L/Q)	m ³ /h	1260/1070/820/680	1680/1530/1320/1190	1680/1530/1320/1190	1950/1600/1440/1200	1950/1600/1440/1200
High sound power		dB	57	62	63	64	64
Sound pressure		dB(A)	42/40/38/35	45/42/38/34	45/42/38/34	47/44/38/34	47/44/38/34
Net dimensions	WxDxH	mm	840x840x204	840x840x246	840x840x246	840x840x288	840x840x288
Packaging dimensions	WxDxH	mm	990x990x310	990x990x330	990x990x330	990x990x380	990x990x380
Net/gross weight		kg	27,0/32,0	31,0/36,0	31,0/36,0	32,0/38,0	32,0/38,0
Panel	Model		PB-950KB(H)	PB-950KB(H)	PB-950KB(H)	PB-950KB(H)	PB-950KB(H)
Panel Net dimensions	WxDxH	mm	950x950x50	950x950x50	950x950x50	950x950x50	950x950x50
Panel Packaging dimensions	WxDxH	mm	1013x1025x123	1013x1025x123	1013x1025x123	1013x1025x123	1013x1025x123
Panel Net/gross weight			6,5/9,5	6,5/9,5	6,5/9,5	6,5/9,5	6,5/9,5
Outdoor Unit							
Power supply		Ph/V/Hz	1/220-240/50/60	1/220-240/50/60	3/380-415/50/60	1/220-240/50/60	3/380-415/50/60
Power cable		N x mm ²	3 x 4,0	3 x 4,0	5 x 4,0	3 x 6,0	5 x 4,0
Interconnection cable		N x mm ²	4 x 2,5	4 x 2,5	4 x 2,5	4 x 2,5	4 x 2,5
Sound power	H	dB	68	66	68	72	72
Sound pressure	H	dB(A)	54	53	54	58	58
Running current cooling/heating	Max	A	13,1	16,5	6,8	26,0	10,0
Starting current cooling/heating	Max	A	2,0	3,0	1,0	4,0	2,0
Net dimensions	WxDxH	mm	890x340x705	920x372x765	920x372x765	950x370x965	950x370x965
Packaging dimensions	WxDxH	mm	1046x460x780	1036x478x820	1085x485x830	1050x485x1130	1050x485x1130
Net/gross weight		kg	44,0/48,0	60,0/65,0	61,0/66,0	84,0/89,0	85,0/90,0
Compressor type			Twin rotary inverter	Twin rotary inverter	Twin rotary inverter	Twin rotary inverter	Twin rotary inverter
Installation data							
Refrigerant			R32	R32	R32	R32	R32
Liquid pipe	Ø	mm (inch)	9,52 (3/8)	9,52 (3/8)	9,52 (3/8)	9,52 (3/8)	9,52 (3/8)
Gas pipe	Ø	mm (inch)	15,88 (5/8)	15,88 (5/8)	15,88 (5/8)	15,88 (5/8)	15,88 (5/8)
Standard pipe length without refrigerant charge		m	10	30	30	30	30
Maximum pipe length		m	50	50	50	50	50
Maximum IU - OU elevation		m	30	30	30	30	30
Refrigerant charge in the factory		kg	1,23	1,70	1,70	2,30	2,30
Refrigerant charge in the factory		TCO _{2eq}	0,83	1,15	1,15	1,55	1,55
Additional ref. charge over std length		g/m	45	45	45	45	45
Outdoor operating limits - COOLING	min-max	°C			-20-46		
Outdoor operating limits - HEATING	min-max	°C			-20-24		

ROUND FLOW CASSETTE



ABH140 - ABH160

1U140

1U140 - 1U160

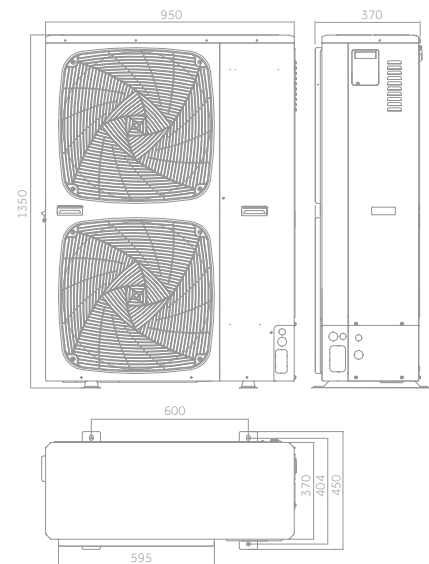
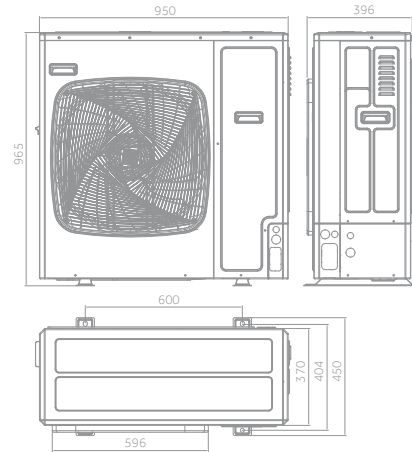
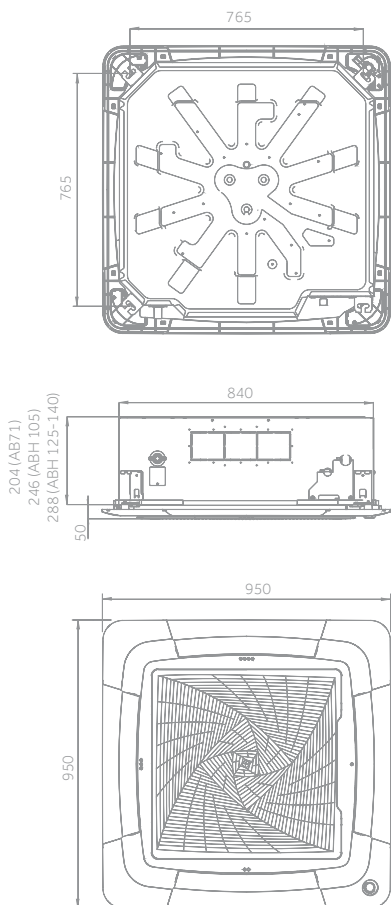

14,0kW - 16,0kW

ROUND FLOW CASSETTE

13,4 kW

15,0 kW

Please see pages 40 & 41
For Controller Options

Silence

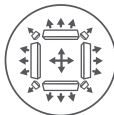
8 Way
Independent

Fresh Air

Integrated
Wi-Fi ControlUVC
Sterilisation

- Low noise level
- 'Fresh air' knockout is incorporated in the chassis to allow fresh air introduction of up to 20% of nominal unit air flow without compromising the cooling capacity. More than 20% of the air conditioner's thermal cooling capacity is penalise
- Integrated Wi-Fi control
- UVC Sterilisation

Indoor Unit	Model		ABH140K1ERG(H)	ABH140K1ERG(H)	ABH140K1ERG(H)	ABH140K1ERG(H)	ABH160K1ERG(H)
Outdoor Unit	Model		1U140S2SN1FA	1U140S2SN1FB	1U140S2SP2FA	1U140S2SP2FB	1U160S2SP1FB
Performance data							
Output power - COOLING	nom (min-max)	kW	13,40 (3,50-14,00)	13,40 (3,50-14,00)	13,60 (4,00-15,00)	13,60 (4,00-15,00)	15,00 (4,50-16,00)
Output power - HEATING	nom (min-max)	kW	15,00 (4,00-15,50)	15,00 (4,00-15,50)	15,00 (4,50-16,00)	15,00 (4,50-16,00)	16,00 (5,00-17,00)
Absorbed power - COOLING	nom (min-max)	kW	5,51 (1,00-6,50)	5,28 (1,00-6,50)	4,86 (1,00-6,00)	4,98 (1,00-6,00)	5,03 (1,00-6,50)
Absorbed power - HEATING	nom (min-max)	kW	5,77 (1,00-6,50)	5,70 (1,00-6,50)	4,75 (1,00-6,00)	4,67 (1,00-6,00)	5,26 (1,00-6,50)
Energy class	EER	W/W	2,43	2,54	2,80	2,73	2,98
	COP	W/W	2,60	2,63	3,10	3,06	3,04
COOLING Pdesign	35 °C	kW	13,40	13,40	13,60	13,60	15,00
HEATING Pdesign	(-10 °C)	kW	8,50	8,50	10	10	11,00
Energy class	SEER		5,60 (A+)	5,62 (A+)	5,70 (A+)	5,70 (A+)	5,96 (A+)
	SCOP		3,93 (A)	3,96 (A)	3,94 (A)	3,99 (A)	3,99 (A)
Annual Energy Consumption - COOLING		kWh/a	838	834	800	782	880
Annual Energy Consumption - HEATING		kWh/a	3032	3003	3768	3748	3859
Indoor Unit							
Power supply		Ph/V/Hz	1/220-240/50/60	1/220-240/50/60	1/220-240/50/60	1/220-240/50/60	1/220-240/50/60
Treated air volume	(H/M/L/Q)	m ³ /h	1950/1600/1440/1200	1950/1600/1440/1200	1950/1600/1440/1200	1950/1600/1440/1200	2050/1600/1440/1220
High sound power		dB	64	64	64	64	65
Sound pressure		dB(A)	47/44/38/34	47/44/38/34	47/44/38/34	47/44/38/34	48/44/38/34
Net dimensions	WxDxH	mm	840x840x288	840x840x288	840x840x288	840x840x288	840x840x288
Packaging dimensions	WxDxH	mm	990x990x380	990x990x380	990x990x380	990x990x380	990x990x380
Net/gross weight		kg	32,0/38,0	32,0/38,0	32,0/38,0	32,0/38,0	32,0/38,0
Panel	Model		PB-950KB(H)	PB-950KB(H)	PB-950KB(H)	PB-950KB(H)	PB-950KB(H)
Panel Net dimensions			950x950x50	950x950x50	950x950x50	950x950x50	950x950x50
Panel Packaging dimensions			1013x1025x123	1013x1025x123	1013x1025x123	1013x1025x123	1013x1025x123
Panel Net/gross weight			6,5/9,5	6,5/9,5	6,5/9,5	6,5/9,5	6,5/9,5
Outdoor Unit							
Power supply		Ph/V/Hz	1/220-240/50/60	3/380-415/50/60	1/220-240/50/60	3/380-415/50/60	3/380-415/50/60
Power cable		N x mm ²	3 x 6,0	5 x 4,0	3 x 6,0	5 x 4,0	5 x 4,0
Interconnection cable		N x mm ²	4 x 2,5	4 x 2,5	4 x 2,5	4 x 2,5	4 x 2,5
Sound power	H	dB	72	72	70	70	72
Sound pressure	H	dB(A)	58	58	53	53	58
Running current cooling/heating	Max	A	30,0	10,0	32,0	10,0	10,0
Starting current cooling/heating	Max	A	5,0	2,0	6,0	2,0	2,0
Net dimensions	WxDxH	mm	950x370x965	950x370x965	950x370x1350	950x370x1350	950x370x1350
Packaging dimensions	WxDxH	mm	1050x485x1130	1050x485x1130	1050x485x1500	1050x485x1500	1050x485x1500
Net/gross weight		kg	84,0/89,0	85,0/90,0	105,0/118,0	101,0/116,0	101,0/116,0
Compressor type			Twin rotary inverter	Twin rotary inverter	Twin rotary inverter	Twin rotary inverter	Twin rotary inverter
Installation data							
Refrigerant			R32	R32	R32	R32	R32
Liquid pipe	∅	mm (inch)	9,52 (3/8)	9,52 (3/8)	9,52 (3/8)	9,52 (3/8)	9,52 (3/8)
Gas pipe	∅	mm (inch)	15,88 (5/8)	15,88 (5/8)	15,88 (5/8)	15,88 (5/8)	19,05 (3/4)
Standard pipe length without refrigerant charge		m	30	30	30	30	30
Maximum pipe length		m	70	70	70	70	70
Maximum IU - OU elevation		m	30	30	30	30	30
Refrigerant charge in the factory		kg	2,30	2,30	2,90	3,50	3,50
Refrigerant charge in the factory		TCO ₂ eq	1,55	1,55	1,96	2,36	2,36
Additional ref. charge over std length		g/m	45	45	45	45	60
Outdoor operating limits - COOLING	min-max	°C			-20-46		
Outdoor operating limits - HEATING	min-max	°C			-20-24		

CEILING FLOOR



CEILING FLOOR

FLOW +

The air is distributed equally in every corner of the room to ensure maximum comfort.

The unit can be installed on the ceiling at a height of 4,2 m.

EASY PCB MAINTENANCE

Easy to wire and maintain PCB: simply open the grille.

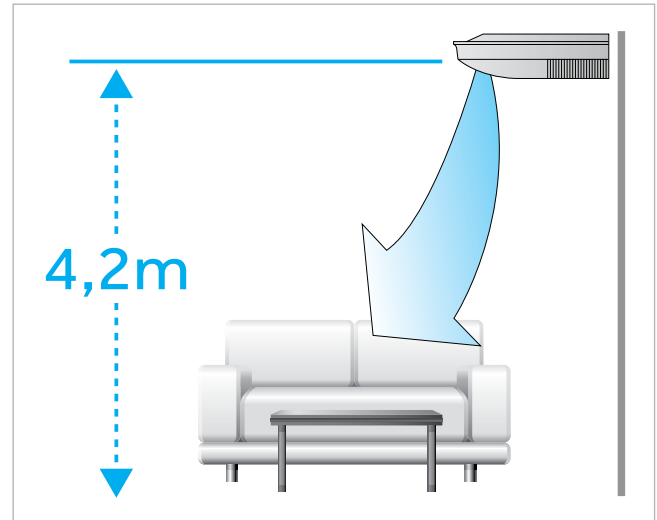

SILENCE

The use of DC Inverter fans and optimised design reduces the noise level of the indoor units.

Minimum level of sound pressure of only 33dB(A).



5 SPEED FAN

The fan speed can be set to 5 different programs:

Turbo - High - Medium - Low - Super Low.

(Only with YR-HB or wired controllers)

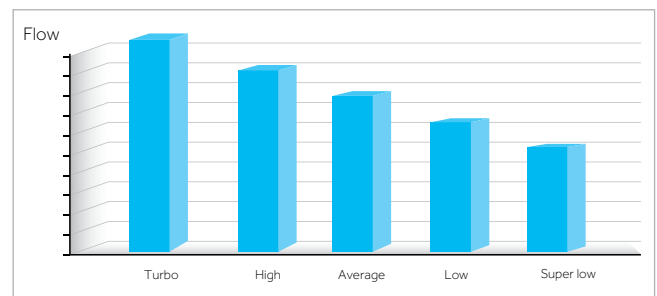

FRESH AIR

Air exchange allows introduction of clean air into the room.

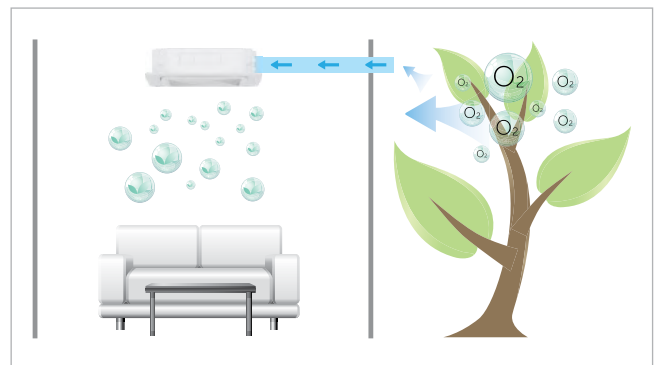



AC25 - AC35 - AC50 - AC71

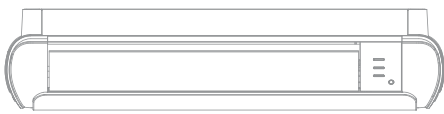

1000 (AC25 - AC50) / 1325 (AC71)

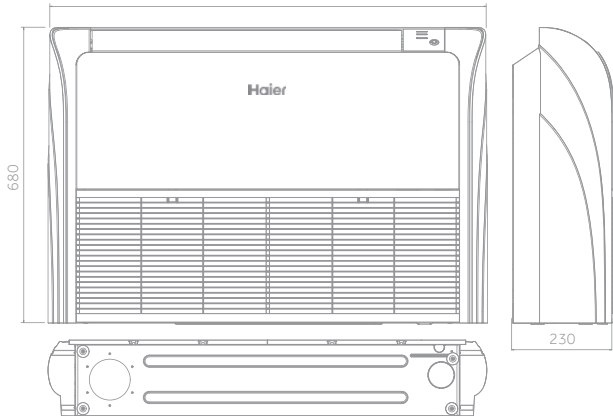

1U25 - 1U35

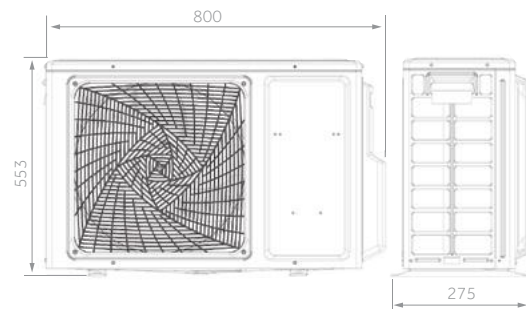

1U50

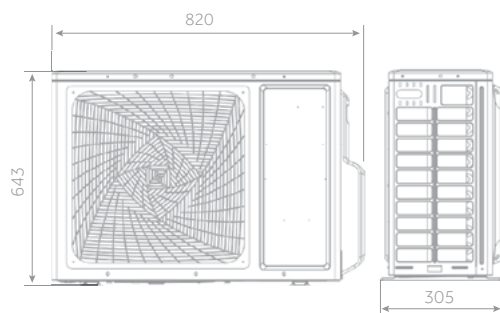

1U71

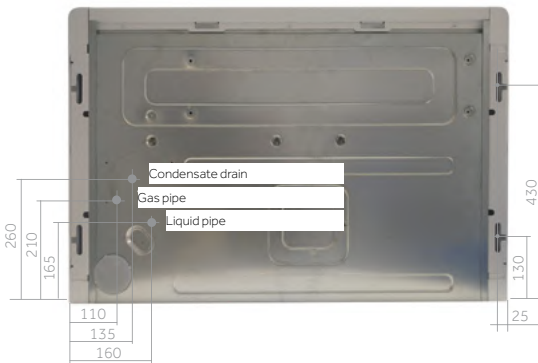
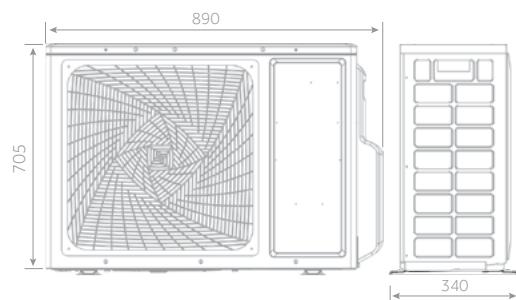

2.5 kW - 3.5kW

5,0 kW

7,1 kW

CEILING FLOOR NEW

Haier

MONOSPLIT



A+++ / A+

2,5 kW

3,5 kW

5,0 kW

7,1 kW

Please see pages 40 & 41 For Controller Options



Silence



Flow +



5 Speed Fan



Fresh Air

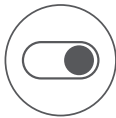

On-Off Card



Integrated Wi-Fi Control



UVC Sterilisation

- Low noise level
- Flow +: Internal deflectors are divided into two groups with independent motors (independent right-left airflow)
- 5 fan speed: turbo, high, medium, low, super low (only with YR-HQS01 or wired controller)

- 'Fresh air' knockout is incorporated in the chassis to allow fresh air introduction of up to 20% of nominal unit air flow without compromising the cooling capacity. More than 20% of the air conditioner's thermal cooling capacity is penalise
- Integrated Wi-Fi control
- UVC Sterilisation

≥AC71) CEILING		≥AC71) FLOOR	
m (kg)	Sup. (m ²)	m (kg)	Sup. (m ²)
1.225	0.95	1.225	12.9
1.4	1.25	1.4	16.8
1.6	1.63	1.6	22.0
1.8	2.07	1.8	27.8
2.0	2.55	2.0	34.3
2.2	3.09	2.2	41.5
2.4	3.68	2.4	49.4
2.6	4.31	2.6	58.0
2.8	5.00	2.8	67.3
3.0	5.74	3.0	77.2



INDOOR UNIT	Model	AC25S2SG1FA(H)	AC35S2SG1FA(H)	AC50S2SG1FA(H)	AC71S2SG1FA(H)	
OUTDOOR UNIT	Model	1U25S2SM1FA-2	1U35S2SM1FA-2	1U50S2S2FA-2	1U71S2ST1FA	
Performance data						
Output power - COOLING	nom (min-max)	kW	2,5 (0,7-4,3)	3,50 (1,00-4,30)	5,00 (1,40-5,70)	7,10 (2,00-7,30)
Output power - HEATING	nom (min-max)	kW	3,1 (0,9-4,6)	4,00 (1,00-5,30)	5,80 (1,40-6,00)	7,80 (2,50-8,50)
Absorbed power - COOLING	nom (min-max)	kW	0,77 (0,25-1,6)	0,91 (0,30-1,50)	1,45 (0,50-2,00)	1,89 (0,50-2,60)
Absorbed power - HEATING	nom (min-max)	kW	0,84 (0,25-1,6)	1,07 (0,50-1,60)	1,56 (0,52-2,35)	1,95 (0,50-3,10)
Energy class	EER	W/W	3,23	3,81	3,48	3,75
	COP	W/W	3,71	3,73	3,73	4,00
COOLING Pdesign	35 °C	kW	2,5	3,50	5,00	7,10
HEATING Pdesign	(-10 °C)	kW	2,8	3,00	4,40	5,00
Energy class	SEER		6,1 (A+++)	8,50 (A+++)	7,31 (A++)	7,15 (A++)
	SCOP		4,0 (A+)	4,47 (A+)	4,10 (A+)	4,25 (A+)
Annual Energy Consumption - COOLING		kWh/a	210	146	240	406
Annual Energy Consumption - HEATING		kWh/a	1398	945	1491	1831
Indoor Unit						
Power supply		Ph/V/Hz	1/220-240/50/60	1/220-240/50/60	1/220-240/50/60	1/220-240/50/60
Treated air volume	(H/M/L/Q)	m ³ /h	580/480/380/280	750/620/500/400	880/750/650/500	1250/1128/930/840
High sound power		dB	50	53	57	61
Sound pressure		dB(A)	35/32/28/26	39/36/33/30	44/41/38/35	43/40/38/35
Net dimensions	WxDxH	mm	1000x230x680	1000x230x680	1000x230x680	1325x230x680
Packaging dimensions	WxDxH	mm	1100x305x779	1100x305x779	1100x305x779	1425x305x779
Net/gross weight		kg	26,0/32,0	26,0/32,0	26,0/32,0	33,5/41,9
Outdoor Unit						
Power supply		Ph/V/Hz	1/220-240/50	1/220-240/50	1/220-240/50	1/220-240/50/60
Power cable		N x mm ²	3 x 1,5	3 x 1,5	3 x 1,5	3 x 4,0
Interconnection cable		N x mm ²	4 x 1,0	4 x 1,0	4 x 1,0	4 x 2,5
Sound power	H	dB	59	61	63	68
Sound pressure	H	dB(A)	47	48	50	54
Running current cooling/heating	Max	A	8,0	8,0	10,68	13,1
Starting current cooling/heating	Max	A	2,0	2,0	2,0	2,0
Net dimensions	WxDxH	mm	800x275x553	800x275x553	820x305x643	890x340x705
Packaging dimensions	WxDxH	mm	902x375x607	902x375x607	940x390x697	1046x460x780
Net/gross weight		kg	27,6/30,4	30,0/32,9	35,7/38,5	44,0/48,0
Compressor type			Rotary inverter	Rotary inverter	Twin rotary inverter	Twin rotary inverter
Installation data						
Refrigerant			R32	R32	R32	R32
Liquid pipe	Ø	mm (inch)	6,35 (1/4)	6,35 (1/4)	6,35 (1/4)	9,52 (3/8)
Gas pipe	Ø	mm (inch)	9,52 (3/8)	9,52 (3/8)	12,70 (1/2)	15,88 (5/8)
Standard pipe length without refrigerant charge		m	7	7	7	10
Maximum pipe length		m	20	20	25	50
Maximum IU - OU elevation		m	10	10	15	30
Refrigerant charge in the factory		kg	0,63	0,78	1,10	1,23
Refrigerant charge in the factory		TCO ₂ eq	0,43	0,53	0,74	0,83
Additional ref. charge over std length		g/m	20	20	20	45
Outdoor operating limits - COOLING	min-max	°C			-20-43	
Outdoor operating limits - HEATING	min-max	°C			-20-24	

The data in this catalogue is purely indicative as the data may vary. Please be advised to check the accuracy of the data with the supplier before purchasing products.

CEILING FLOOR



AC105 - AC125

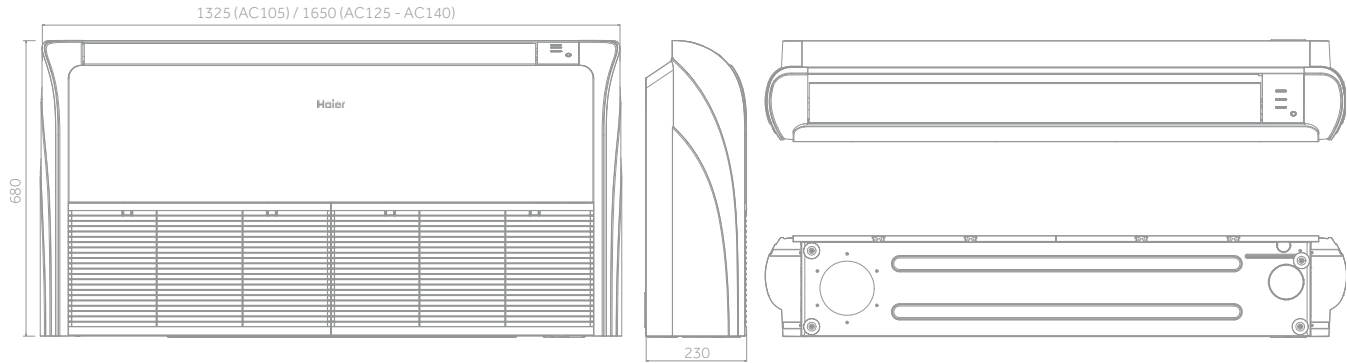

1U105

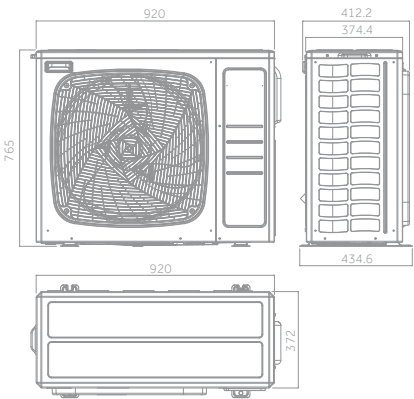

10,5 kW

1U125

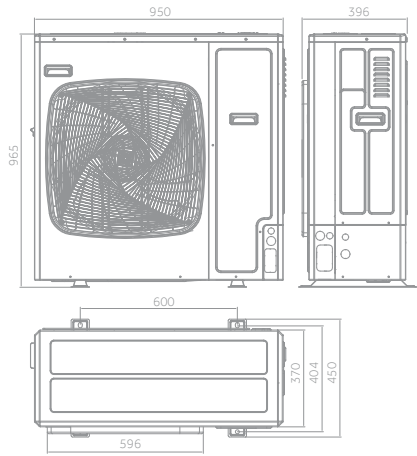

12,5 kW



CEILING FLOOR

Haier

MONOSPLIT

9,5 kW

12,3 kW

Please see pages 40 & 41
For Controller Options



A+++ / A+



Silence



Flow +



5 Speed Fan



Fresh Air



On-Off Card



Integrated
Wi-Fi Control



UVC
Sterilisation

≥AC71) CEILING		≥AC71) FLOOR	
m (kg)	Sup. (m²)	m (kg)	Sup. (m²)
1,23	0,95	1,23	12,90
1,40	1,25	1,40	16,80
1,60	1,63	1,60	22,00
1,80	2,07	1,80	27,80
2,00	2,55	2,00	34,30
2,20	3,09	2,20	41,50
2,40	3,68	2,40	49,40
2,60	4,31	2,60	58,00
2,80	5,00	2,80	67,30
3,00	5,74	3,00	77,20

- Low noise level
- Flow +: Internal deflectors are divided into two groups with independent motors (independent right-left airflow)
- 5 fan speed: turbo, high, medium, low, super low (only with YR-HQS01 or wired controller)

- 'Fresh air' knockout is incorporated in the chassis to allow fresh air introduction of up to 20% of nominal unit air flow without compromising the cooling capacity. More than 20% of the air conditioner's thermal cooling capacity is penalise
- Integrated Wi-Fi control
- UVC Sterilisation



INDOOR UNIT	Model	AC105S2SH1FA(H)	AC105S2SH1FA(H)	AC125S2SK1FA(H)	AC125S2SK1FA(H)
OUTDOOR UNIT	Model	1U105S2SS2FA	1U105S2SS1FB	1U125S2SN2FA	1U125S2SN2FB
Performance data					
Output power - COOLING	nom (min-max)	kW	9,50 (2,50-10,00)	9,50 (2,50-10,00)	12,30 (3,00-13,00)
Output power - HEATING	nom (min-max)	kW	10,20 (3,00-10,50)	10,50 (3,00-11,00)	12,70 (3,50-13,50)
Absorbed power - COOLING	nom (min-max)	kW	3,13 (0,50-4,00)	3,25 (0,50-4,00)	4,54 (1,00-6,00)
Absorbed power - HEATING	nom (min-max)	kW	3,07 (0,50-4,00)	3,10 (0,50-4,00)	3,96 (1,00-6,00)
Energy class	EER	W/W	3,04	2,90	2,71
	COP	W/W	3,32	3,50	3,21
COOLING Pdesign	35 °C	kW	9,50	9,50	12,30
HEATING Pdesign	(-10 °C)	kW	7,00	6,00	8,00
Energy class	SEER		6,11 (A++)	6,11 (A++)	5,86 (A+)
	SCOP		3,80 (A)	3,91 (A)	3,97 (A)
Annual Energy Consumption - COOLING		kWh/a	549	557	738
Annual Energy Consumption - HEATING		kWh/a	2750	2228	2995
Indoor Unit					
Power supply		Ph/V/Hz	1/220-240/50/60	1/220-240/50/60	1/220-240/50/60
Treated air volume	(H/M/L/Q)	m³/h	1600/1400/1280/1160	1600/1400/1280/1160	2050/1900/1600/1400
High sound power		dB	61	63	64
Sound pressure		dB(A)	47/43/41/37	47/43/41/37	46/43/41/38
Net dimensions	WxDxH	mm	1325x230x680	1325x230x680	1650x230x680
Packaging dimensions	WxDxH	mm	1425x305x779	1425x305x779	1750x305x779
Net/gross weight		kg	33,5/41,9	33,5/41,9	43,0/51,0
Outdoor Unit					
Power supply		Ph/V/Hz	1/220-240/50/60	3/380-415/50/60	1/220-240/50/60
Power cable		N x mm²	3 x 4,0	5 x 4,0	3 x 6,0
Interconnection cable		N x mm²	4 x 2,5	4 x 2,5	4 x 2,5
Sound power	H	dB	66	68	72
Sound pressure	H	dB(A)	53	54	58
Running current cooling/heating	Max	A	16,5	6,8	26,0
Starting current cooling/heating	Max	A	3,0	1,0	4,0
Net dimensions	WxDxH	mm	920x372x765	920x372x765	950x370x965
Packaging dimensions	WxDxH	mm	1036x478x820	1085x485x830	1050x485x1130
Net/gross weight		kg	60,0/65,0	61,0/66,0	84,0/89,0
Compressor type			Twin rotary inverter	Twin rotary inverter	Twin rotary inverter
Installation data					
Refrigerant			R32	R32	R32
Liquid pipe	∅	mm (inch)	9,52 (3/8)	9,52 (3/8)	9,52 (3/8)
Gas pipe	∅	mm (inch)	15,88 (5/8)	15,88 (5/8)	15,88 (5/8)
Standard pipe length without refrigerant charge		m	30	30	30
Maximum pipe length		m	50	50	50
Maximum IU - OU elevation		m	30	30	30
Refrigerant charge in the factory		kg	1,70	1,70	2,30
Refrigerant charge in the factory		TCO2eq	1,15	1,15	1,55
Additional ref. charge over std length		g/m	45	45	45
Outdoor operating limits - COOLING	min-max	°C			-20-46
Outdoor operating limits - HEATING	min-max	°C			-20-24

CEILING FLOOR



AC140 - AC160

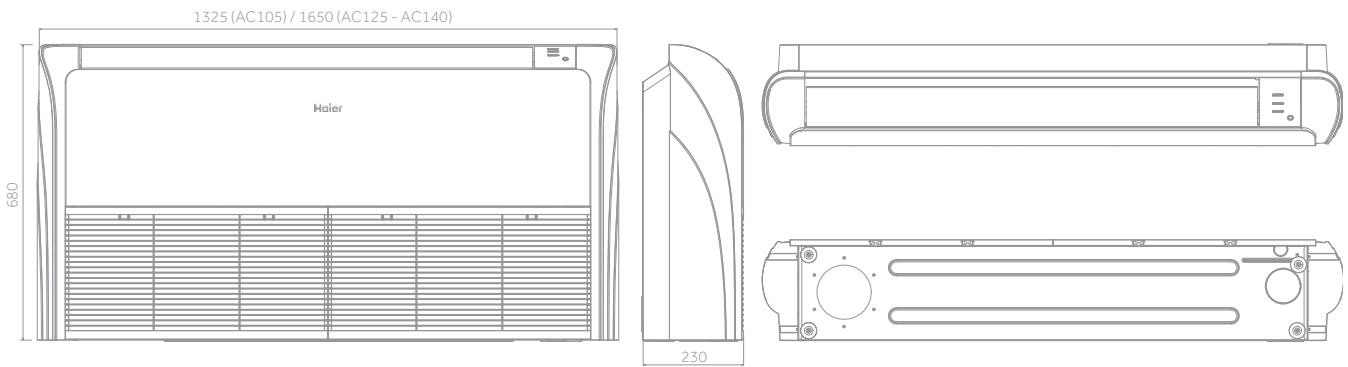

1U140

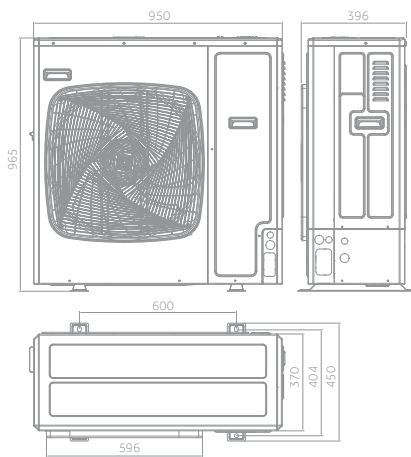

1U140 - 1U160

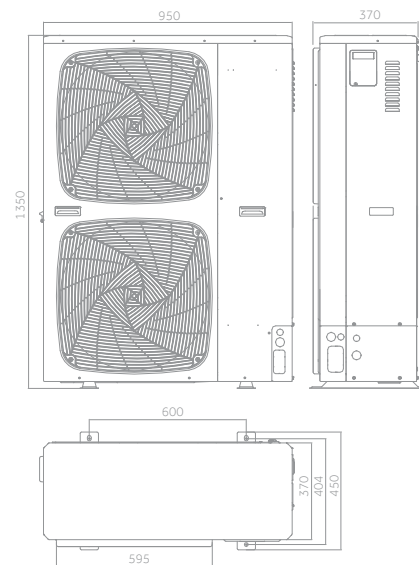

14,0kW - 16,0kW

CEILING FLOOR

Haier

13,4 kW

16,0 kW

Please see pages 40 & 41
For Controller Options



A+ / A



Silence



Flow +



5 Speed Fan



Fresh Air

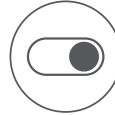

On-Off Card



Integrated Wi-Fi Control



UVC Sterilisation

≥AC71) CEILING		≥AC71) FLOOR	
m (kg)	Sup. (m ²)	m (kg)	Sup. (m ²)
1,23	0,95	1,23	12,90
1,40	1,25	1,40	16,80
1,60	1,63	1,60	22,00
1,80	2,07	1,80	27,80
2,00	2,55	2,00	34,30
2,20	3,09	2,20	41,50
2,40	3,68	2,40	49,40
2,60	4,31	2,60	58,00
2,80	5,00	2,80	67,30
3,00	5,74	3,00	77,20

- Low noise level
- Flow +: Internal deflectors are divided into two groups with independent motors (independent right-left airflow)
- 5 fan speed: turbo, high, medium, low, super low (only with YR-HQS01 or wired controller)
- 'Fresh air' knockout is incorporated in the chassis to allow fresh air introduction of up to 20% of nominal unit air flow without compromising the cooling capacity. More than 20% of the air conditioner's thermal cooling capacity is penalise
- Integrated Wi-Fi control
- UVC Sterilisation



INDOOR UNIT	Model	AC140S2SK1FA(H)	AC140S2SK1FA(H)	AC140S2SK1FA(H)	AC140S2SK1FA(H)	AC160S2SK1FA(H)
OUTDOOR UNIT	Model	1U140S2SN1FA	1U140S2SN1FB	1U140S2SP2FA	1U140S2SP2FB	1U160S2SP1FB
Performance data						
Output power - COOLING	nom (min-max)	kW	13,4 (3,5 -14,0)	13,4 (3,5-14,0)	13,6 (4,0-15,0)	13,6 (4,0-15,0)
Output power - HEATING	nom (min-max)	kW	15,0 (4,0-15,5)	15,0 (4,0-15,5)	15,0 (4,5-16,0)	15,0 (4,5-16,0)
Absorbed power - COOLING	nom (min-max)	kW	5,23(1,0-6,5)	5,13(1,0-6,5)	4,53(1,0-6,0)	4,53(1,0-6,0)
Absorbed power - HEATING	nom (min-max)	kW	5,08(1,0-6,5)	4,97(1,0-6,5)	4,17(1,0-6,0)	4,29(1,0-6,0)
Energy class	EER	W/W	2,56	2,61	3	3
	COP	W/W	2,95	3,02	3,6	3,5
COOLING Pdesign	35 °C	kW	13,4	13,4	13,6	13,6
HEATING Pdesign	(-10 °C)	kW	8,5	8,5	10	10
Energy class	SEER		5,92 (A+)	5,97 (A+)	6,16 (A++)	6,18 (A++)
	SCOP		3,97 (A)	4 (A+)	4,06 (A+)	4,06 (A+)
Annual Energy Consumption - COOLING		kWh/a	792	786	761	759
Annual Energy Consumption - HEATING		kWh/a	2995	2976	3791	3791
Indoor Unit						
Power supply		Ph/V/Hz	1/220-240/50/60	1/220-240/50/60	1/220-240/50/60	1/220-240/50/60
Treated air volume	(H/M/L/Q)	m ³ /h	2150/1980/1800/1600	2150/1980/1800/1600	2150/1980/1800/1600	2250/2000/1850/1650
High sound power		dB	66	66	66	66
Sound pressure		dB(A)	48/46/43/40	48/46/43/40	48/46/43/40	48/46/43/40
Net dimensions	WxDxH	mm	1650x230x680	1650x230x680	1650x230x680	1650x230x680
Packaging dimensions	WxDxH	mm	1750x305x779	1750x305x779	1750x305x779	1750x305x779
Net/gross weight		kg	43/51	43/51	43/51	43/51
Outdoor Unit						
Power supply		Ph/V/Hz	1/220-240/50/60	3/380-415/50/60	1/220-240/50/60	3/380-415/50/60
Power cable		N x mm ²	3 x 6,0	5 x 4,0	5 x 6,0	5 x 4,0
Interconnection cable		N x mm ²	4 x 2,5	4 x 2,5	4 x 2,5	4 x 2,5
Sound power	H	dB	72	72	70	72
Sound pressure	H	dB(A)	58	58	53	53
Running current cooling/heating	Max	A	30,0	10,0	32,0	10,0
Starting current cooling/heating	Max	A	5,0	2,0	6,0	2,0
Net dimensions	WxDxH	mm	950x370x965	950x370x965	950x370x1350	950x370x1350
Packaging dimensions	WxDxH	mm	1050x485x1130	1050x485x1130	1050x485x1500	1050x485x1500
Net/gross weight		kg	84/89	85/90	105/118	101/116
Compressor type			Twin Rotary Inverter	Twin Rotary Inverter	Twin Rotary Inverter	Twin Rotary Inverter
Installation data						
Refrigerant			R32	R32	R32	R32
Liquid pipe	Ø	mm (inch)	9,52 (3/8)	9,52 (3/8)	9,52 (3/8)	9,52 (3/8)
Gas pipe	Ø	mm (inch)	15,88 (5/8)	15,88 (5/8)	15,88 (5/8)	19,05 (3/4)
Standard pipe length without refrigerant charge		m	30	30	30	30
Maximum pipe length		m	70	70	70	70
Maximum IU - OU elevation		m	30	30	30	30
Refrigerant charge in the factory		kg	2,3	2,3	2,9	3,5
Refrigerant charge in the factory		TCO ₂ eq	1,55	1,55	1,96	2,36
Additional ref. charge over std length		g/m	45	45	45	60
Outdoor operating limits - COOLING	min-max	°C	-20-46			
Outdoor operating limits - HEATING	min-max	°C	-20-24			

The data in this catalogue is purely indicative as the data may vary. Please be advised to check the accuracy of the data with the supplier before purchasing products.

SLIM DUCT LOW PRESSURE



THE PANEL KIT (OPTIONAL) INCLUDES:

Air supply grill equipped with vertical and horizontal fins motorised 3D effect - receiver - display

Air intake grill equipped with filter

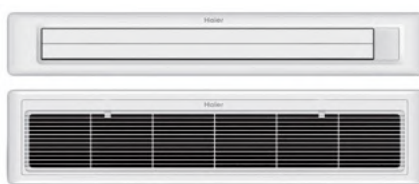

AD25 - AD35 - AD50 - AD71

1U25- 1U35

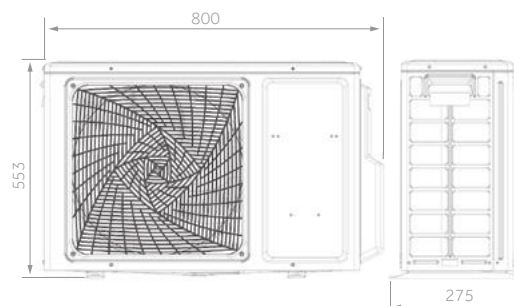
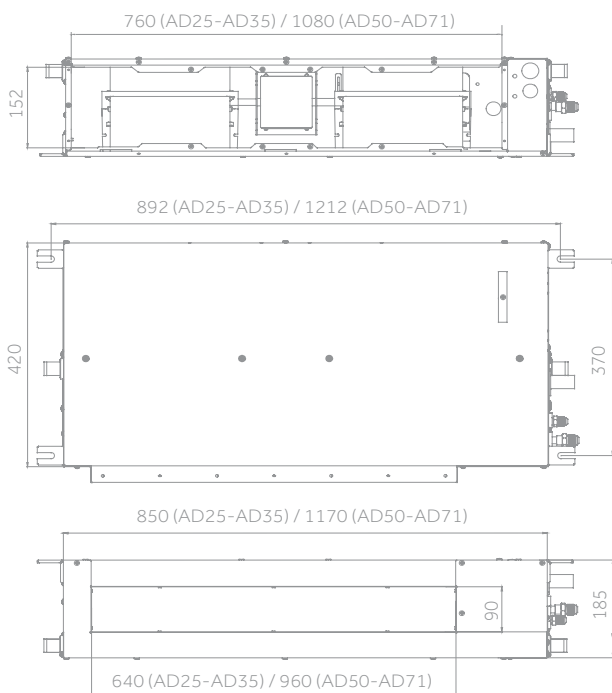

1U50

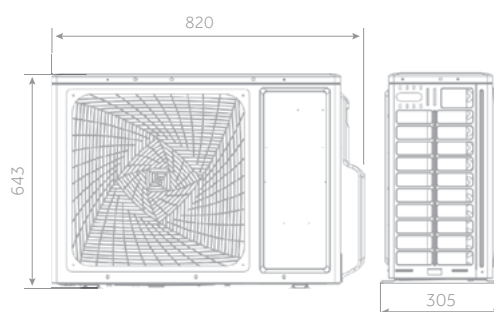

1U71

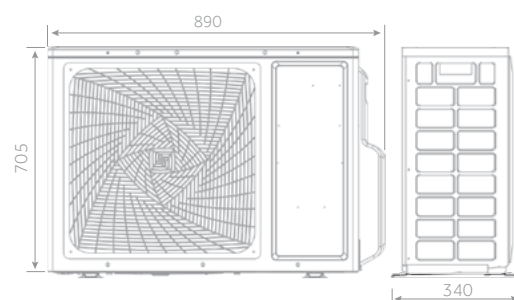

2.5 kW - 3.5kW

5,0 kW

7,1 kW

SLIM DUCT LOW PRESSURE ^{NEW}

Haier

2,5 kW

3,5 kW

5,0 kW

7,1 kW

Please see pages 40 & 41
For Controller Options



A++ / A+

MONOSPLIT

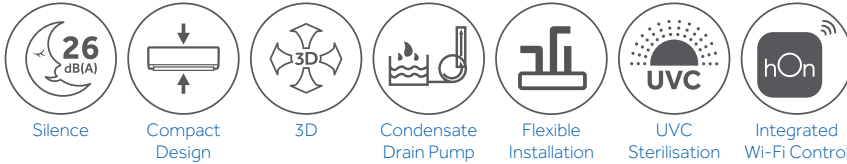

- Low noise level
- Compact design
- Panel kit (OPTIONAL):
air supply and intake grill
- Condensate drain pump
- Flexible installation
- UCV Sterilisation
- Integrated Wi-Fi control

INDOOR UNIT	Model	AD25S2SS1FA(H)	AD35S2SS1FA(H)	AD50S2SS1FA(H)	AD71S2SS1FA(H)	
OUTDOOR UNIT	Model	1U25S2SM1FA-2	1U35S2SM1FA-2	1U50S2S2J2FA-2	1U71S2ST1FA	
Performance data						
Output power - COOLING	nom (min-max) kW	2,5 (0,7-4,3)	3,50 (0,90-4,50)	5,00 (1,80-6,00)	6,8 (2,00-7,30)	
Output power - HEATING	nom (min-max) kW	3,23 (0,9-4,6)	4,00 (1,00-4,80)	5,50 (2,00-6,20)	7,50 (2,50-8,00)	
Absorbed power - COOLING	nom (min-max) kW	0,89 (0,25-1,6)	1,06 (0,28-1,80)	1,53 (0,55-2,10)	2,00 (0,50-2,60)	
Absorbed power - HEATING	nom (min-max) kW	0,87 (0,25-1,6)	1,07 (0,28-1,80)	1,47 (0,60-2,10)	1,97 (0,50-2,60)	
Energy class	EER	W/W	2,8	3,30	3,26	3,4
	COP	W/W	3,71	3,73	3,73	3,8
COOLING Pdesign	35 °C	kW	2,5	3,50	5,00	7,10
HEATING Pdesign	(-10 °C)	kW	2,8	3,00	4,30	5,00
Energy class	SEER		6,10 (A++)	6,10 (A++)	6,10 (A++)	6,10 (A++)
	SCOP		4,00 (A+)	3,80 (A)	4,00 (A+)	4,00 (A+)
Annual Energy Consumption - COOLING	kWh/a	210	241	315	406	
Annual Energy Consumption - HEATING	kWh/a	1398	1427	1961	1831	
Indoor Unit						
Power supply		Ph/V/Hz	1/220-240/50/60	1/220-240/50/60	1/220-240/50/60	1/220-240/50/60
Treated air volume	(H/M/L/Q)	m ³ /h	580/480/380	600/480/420	900/750/600	1000/850/750
External static pressure		Pa	0/10/20/40			
High sound power		dB	50	53	54	59
Sound pressure		dB(A)	32/28/26	33/28/25	36/34/32	46/44/42
Net dimensions	WxDxH	mm	850x420x185	850x420x185	1170x420x185	1170x420x185
Packaging dimensions	WxDxH	mm	1045x530x260	1045x530x260	1365x530x260	1365x530x260
Net/gross weight		kg	16,0/21,0	16,0/21,0	22,8/27,0	25,2/28,4
Panel (optional)	Model		P1B-890IA/D	P1B-890IA/D	P1B-1210IA/D	P1B-1210IA/D
Panel Net dimensions	WxDxH	mm	890x190x100 (outlet panel) 890x290,5x32,4 (inlet panel)		1210x190x100 (outlet panel) 1210x290,5x32,4 (inlet panel)	
Panel Packaging dimensions	WxDxH	mm	938x335x220	938x335x220	1258x335x220	1258x335x220
Panel Net/gross weight			4,0/5,0	4,0/5,0	5,0/6,0	5,0/6,0
Outdoor Unit						
Power supply		Ph/V/Hz	1/220-240/50	1/220-240/50	1/220-240/50	1/220-240/50/60
Power cable		N x mm ²	3 x 1,5	3 x 1,5	3 x 1,5	3 x 4,0
Interconnection cable		N x mm ²	4 x 1,0	4 x 1,0	4 x 1,0	4 x 2,5
Sound power	H	dB	59	61	63	68
Sound pressure	H	dB(A)	47	48	50	54
Running current cooling/heating	Max	A	8,0	8,0	10,68	13,1
Starting current cooling/heating	Max	A	2,0	2,0	2,0	2,0
Net dimensions	WxDxH	mm	800x275x553	800x275x553	820x305x643	890x340x705
Packaging dimensions	WxDxH	mm	902x375x607	902x375x607	940x390x697	1046x460x780
Net/gross weight		kg	27,6/30,4	30,0/32,9	35,7/38,5	44,0/48,0
Compressor type			Rotary inverter	Rotary inverter	Rotary inverter	Twin rotary inverter
Installation data						
Refrigerant			R32	R32	R32	R32
Liquid pipe	∅	mm (inch)	6,35 (1/4)	6,35 (1/4)	6,35 (1/4)	9,52 (3/8)
Gas pipe	∅	mm (inch)	9,52 (3/8)	9,52 (3/8)	12,70 (1/2)	15,88 (5/8)
Standard pipe length without refrigerant charge		m	7	7	7	10
Maximum pipe length		m	20	20	25	50
Maximum IU - OU elevation		m	10	10	15	30
Refrigerant charge in the factory		kg	0,63	0,78	1,10	1,23
Refrigerant charge in the factory		TCO ₂ eq	0,43	0,53	0,74	0,83
Additional ref. charge over std length		g/m	20	20	20	45
Outdoor operating limits - COOLING	min-max	°C		-20-43		-20-46
Outdoor operating limits - HEATING	min-max	°C		-20-24		-20-24

DUCTED MEDIUM PRESSURE



DUCTED MEDIUM PRESSURE

COMPACT DESIGN

The unit has a thickness of 248 mm which allows better adaptation and ease of installation.



CONDENSATE DRAIN

The medium-pressure ducted units includes a condensate drain pump as standard. This guarantees a maximum prevalence of 600 mm measured from the base of the machine. There is the possibility of performing condensate drain by gravity (reversible on both sides).

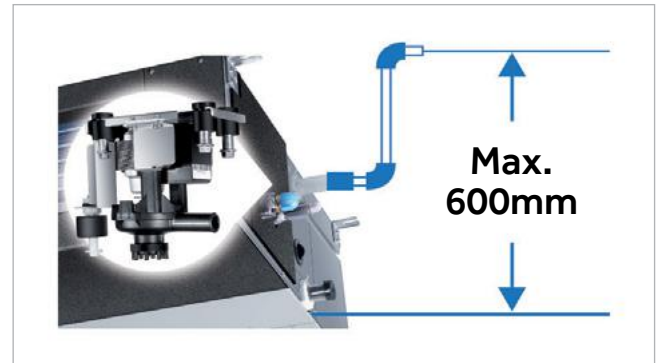

EASY INSTALLATION

- The connection of electrical cables is now possible through only one screw.
- The ducted units have two options for connecting the air extraction channel: rear or lower.

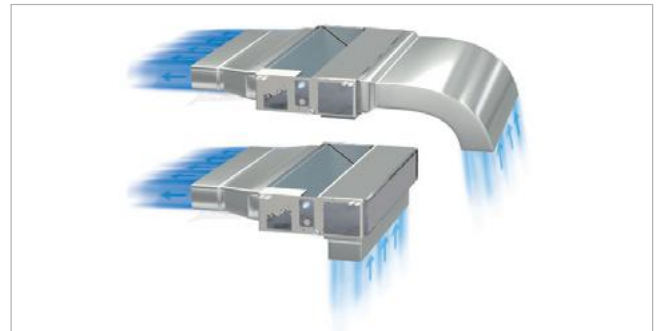

Wi-Fi

Besides normal wired/infrared control, Haier supplies Smart Control from hOn APP. Including the on/off, Operation mode selection, fan speed temperature, and air flow adjustment, schedule, UV function and steri-clean 56°C, etc.



FRESH AIR

Air exchange allows introduction of clean air into the room.

UVC Sterilisation

The built-in LED UV lights kill airborne hazards when the air circulates from air inlet, ensuring the clean air out.



Flexible air distribution

The ducted units satisfy multiple installation solutions (circular or rectangular channels).

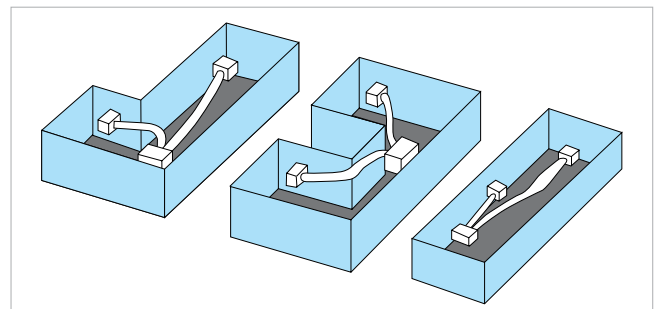

DUCTED MEDIUM PRESSURE



AD35 - AD50 - AD71

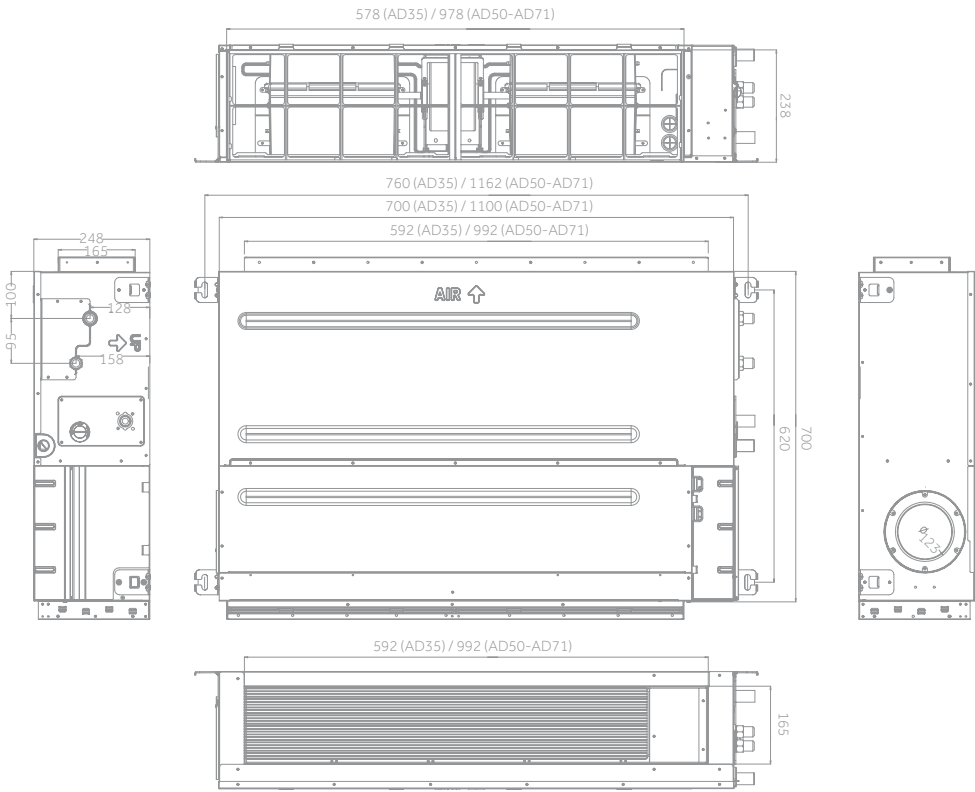

1U35

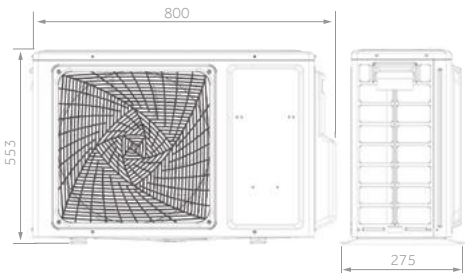

1U50

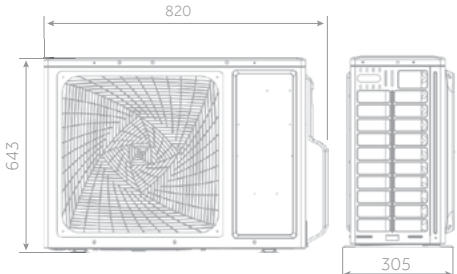

1U71

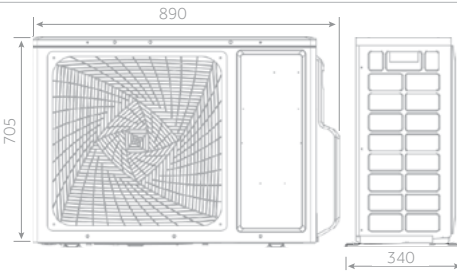

3,5 kW

5,0 kW

7,1 kW

DUCTED MEDIUM PRESSURE



A++ / A

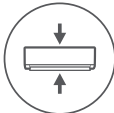

Silence

Compact
Design

3D

Condensate
Drain PumpFlexible
InstallationUVC
SterilisationIntegrated
Wi-Fi Control

- Low noise level
- Compact design
- 'Fresh air' knockout is incorporated in the chassis to allow fresh air introduction of up to 20% of nominal unit air flow without compromising the cooling capacity.
- Condensate drain pump
- UCV Sterilisation
- Integrated Wi-Fi control



INDOOR UNIT	Model	AD35S2SM3FA(H)	AD50S2SM3FA(H)	AD71S2SM3FA(H)	
OUTDOOR UNIT	Model	1U35S2SM1FA-2	1U50S2SJ2FA-2	1U71S2ST1FA	
Performance data					
Output power - COOLING	nom (min-max)	kW	3,50 (0,90-4,50)	5,00 (1,80-6,00)	7,10 (2,00-7,30)
Output power - HEATING	nom (min-max)	kW	4,00 (1,00-4,80)	6,00 (2,00-6,20)	7,60 (2,50-8,00)
Absorbed power - COOLING	nom (min-max)	kW	1,08 (0,28-1,80)	1,55 (0,55-2,00)	2,08 (0,50-2,60)
Absorbed power - HEATING	nom (min-max)	kW	1,08 (0,28-1,80)	1,48 (0,60-2,00)	2,00 (0,50-2,60)
Energy class	EER	W/W	3,23	3,23	3,42
	COP	W/W	3,71	3,71	3,80
COOLING Pdesign	35 °C	kW	3,50	5,00	6,80
HEATING Pdesign	(-10 °C)	kW	2,70	4,50	5,00
Energy class	SEER		6,10 (A++)	6,10 (A++)	6,83 (A++)
	SCOP		3,80 (A)	4,00 (A+)	4,25 (A+)
Annual Energy Consumption - COOLING		kWh/a	215	291	406
Annual Energy Consumption - HEATING		kWh/a	1020	1782	1831
Indoor Unit					
Power supply		Ph/V/Hz	1/220-240/50/60	1/220-240/50/60	1/220-240/50/60
Treated air volume	(H/M/L/Q)	m ³ /h	840/720/600/450	1020/900/780/550	1440/1260/1100/900
External static pressure		Pa	25(default)/37/50/70/90/100/110/120/130/150		
High sound power		dB	55	56	60
Sound pressure		dB(A)	41/35/28/26	43/37/30/28	44/41/39/36
Net dimensions	WxDxH	mm	700x700x248	1100x700x248	1100x700x248
Packaging dimensions	WxDxH	mm	914x866x318	1316x866x318	1316x866x318
Net/gross weight		kg	26,0/30,0	31,0/35,0	31,0/35,0
Outdoor Unit					
Power supply		Ph/V/Hz	1/220-240/50	1/220-240/50	1/220-240/50/60
Power cable		N x mm ²	3 x 1,5	3 x 1,5	3 x 4,0
Interconnection cable		N x mm ²	4 x 1,0	4 x 1,0	4 x 2,5
Sound power	H	dB	61	63	68
Sound pressure	H	dB(A)	48	50	54
Running current cooling/heating	Max	A	8,0	10,68	13,1
Starting current cooling/heating	Max	A	2,0	2,0	2,0
Net dimensions	WxDxH	mm	800x275x553	820x305x643	890x340x705
Packaging dimensions	WxDxH	mm	902x375x605	940x390x697	1046x460x780
Net/gross weight		kg	30,0/32,9	35,7/38,5	44,0/48,0
Compressor type			Rotary inverter	Rotary inverter	Twin rotary inverter
Installation data					
Refrigerant			R32	R32	R32
Liquid pipe	∅	mm (inch)	6,35 (1/4)	6,35 (1/4)	9,52 (3/8)
Gas pipe	∅	mm (inch)	9,52 (3/8)	12,70 (1/2)	15,88 (5/8)
Standard pipe length without refrigerant charge		m	7	7	10
Maximum pipe length		m	20	25	50
Maximum IU - OU elevation		m	10	15	30
Refrigerant charge in the factory		kg	0,78	1,10	1,23
Refrigerant charge in the factory		TCO _{2eq}	0,53	0,74	0,88
Additional ref. charge over std length		g/m	20	20	45
Outdoor operating limits - COOLING	min-max	°C	-20-43		-20-46
Outdoor operating limits - HEATING	min-max	°C	-20-24		-20-24

DUCTED MEDIUM PRESSURE



AD105 - AD125

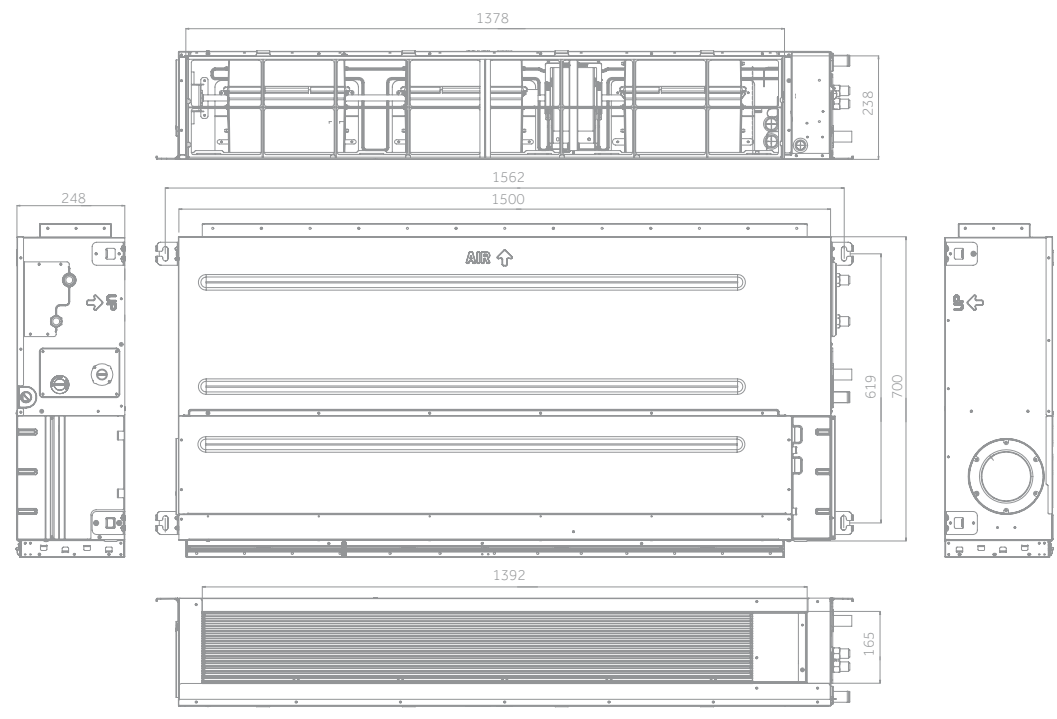

1U105

1U125

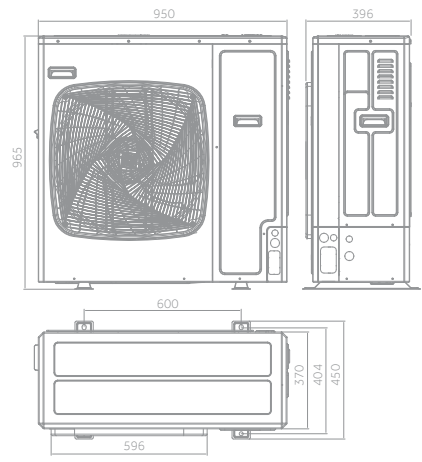
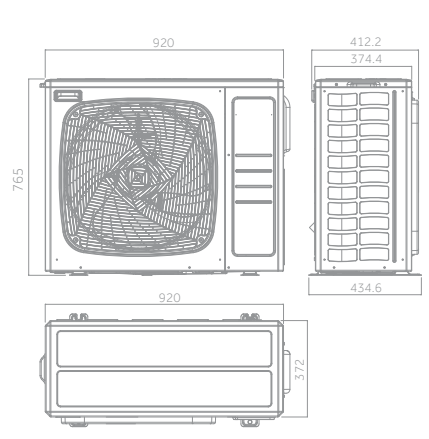

10,5 kW



12,5 kW

DUCTED MEDIUM PRESSURE

10,5 kW

12,5 kW

Please see pages 40 & 41
For Controller Options

A++ / A

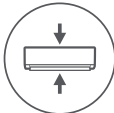

Silence

Compact
Design

3D

Condensate
Drain PumpFlexible
InstallationUVC
SterilisationIntegrated
Wi-Fi Control

- Low noise level
- Compact design
- 'Fresh air' knockout is incorporated in the chassis to allow fresh air introduction of up to 20% of nominal unit air flow without compromising the cooling capacity.
- Condensate drain pump
- UCV Sterilisation
- Integrated Wi-Fi control



INDOOR UNIT	Model		AD105S2SM3FA(H)	AD105S2SM3FA(H)	AD125S2SM8FA(H)	AD125S2SM8FA(H)
OUTDOOR UNIT	Model		1U105S2SS2FA	1U105S2SS1FB	1U125S2SN2FA	1U125S2SN2FB
Performance data						
Output power - COOLING	nom (min-max)	kW	9,50 (2,50-10,00)	9,50 (2,50-10,00)	12,30 (3,00-13,00)	12,40 (3,00-13,00)
Output power - HEATING	nom (min-max)	kW	10,20 (3,00-10,50)	10,50 (3,00-11,00)	12,70 (3,50-13,50)	12,80 (3,50-13,50)
Absorbed power - COOLING	nom (min-max)	kW	3,16 (0,50-4,00)	3,27 (0,50-4,00)	4,60 (1,00-6,00)	4,51 (1,00-6,00)
Absorbed power - HEATING	nom (min-max)	kW	2,91 (0,50-4,00)	3,00 (0,50-4,00)	3,93 (1,00-6,00)	3,87 (1,00-6,00)
Energy class	EER	W/W	3,01	2,90	2,67	2,75
	COP	W/W	3,50	3,50	3,23	3,31
COOLING Pdesign	35 °C	kW	9,50	9,50	12,30	12,40
HEATING Pdesign	(-10 °C)	kW	7,20	6,00	8,00	8,00
Energy class	SEER		6,10 (A++)	6,00 (A+)	5,72 (A+)	5,85 (A+)
	SCOP		3,80 (A)	3,91 (A)	3,93 (A)	3,96 (A)
Annual Energy Consumption - COOLING		kWh/a	544	569	735	718
Annual Energy Consumption - HEATING		kWh/a	2792	2094	3032	3003
Indoor Unit						
Power supply		Ph/V/Hz	1/220-240/50/60	1/220-240/50/60	1/220-240/50/60	1/220-240/50/60
Treated air volume	(H/M/L/Q)	m3/h	1600/1480/1360/1240	1600/1480/1360/1240	2250/1960/1680/1500	2250/1960/1680/1500
External static pressure		Pa	25/37(default)/50/70/90/100/110/120/130/150			
High sound power		dB	61	64	65	65
Sound pressure		dB(A)	47/44/40/37	47/44/40/37	48/45/42/39	48/45/42/39
Net dimensions	WxDxH	mm	1500x700x248	1500x700x248	1500x700x248	1500x700x248
Packaging dimensions	WxDxH	mm	1711x870x325	1711x870x325	1711x870x325	1711x870x325
Net/gross weight		kg	46,0/55,0	46,0/55,0	48,0/57,0	48,0/57,0
Outdoor Unit						
Power supply		Ph/V/Hz	1/220-240/50/60	3/380-415/50/60	1/220-240/50/60	3/380-415/50/60
Power cable		N x mm2	3 x 4,0	5 x 4,0	3 x 6,0	5 x 4,0
Interconnection cable		N x mm2	4 x 2,5	4 x 2,5	4 x 2,5	4 x 2,5
Sound power	H	dB	66	68	72	72
Sound pressure	H	dB(A)	53	54	58	58
Running current cooling/heating	Max	A	16,5	6,8	26,0	10,0
Starting current cooling/heating	Max	A	3,0	1,0	4,0	2,0
Net dimensions	WxDxH	mm	920x372x765	920x372x765	950x370x965	950x370x965
Packaging dimensions	WxDxH	mm	1036x478x820	1085x485x830	1050x485x1130	1050x485x1130
Net/gross weight		kg	60,0/65,0	61,0/66,0	84,0/89,0	85,0/90,0
Compressor type			Twin rotary inverter	Twin rotary inverter	Twin rotary inverter	Twin rotary inverter
Installation data						
Refrigerant			R32	R32	R32	R32
Liquid pipe	∅	mm (inch)	9,52 (3/8)	9,52 (3/8)	9,52 (3/8)	9,52 (3/8)
Gas pipe	∅	mm (inch)	15,88 (5/8)	15,88 (5/8)	15,88 (5/8)	15,88 (5/8)
Standard pipe length without refrigerant charge		m	30	30	30	30
Maximum pipe length		m	50	50	50	50
Maximum IU - OU elevation		m	30	30	30	30
Refrigerant charge in the factory		kg	1,70	1,70	2,30	2,30
Refrigerant charge in the factory		TCO2eq	1,15	1,15	1,55	1,55
Additional ref, charge over std length		g/m	45	45	45	45
Outdoor operating limits - COOLING	min-max	°C	-20~46			
Outdoor operating limits - HEATING	min-max	°C	-20~24			

DUCTED MEDIUM PRESSURE



AD140 - AD160

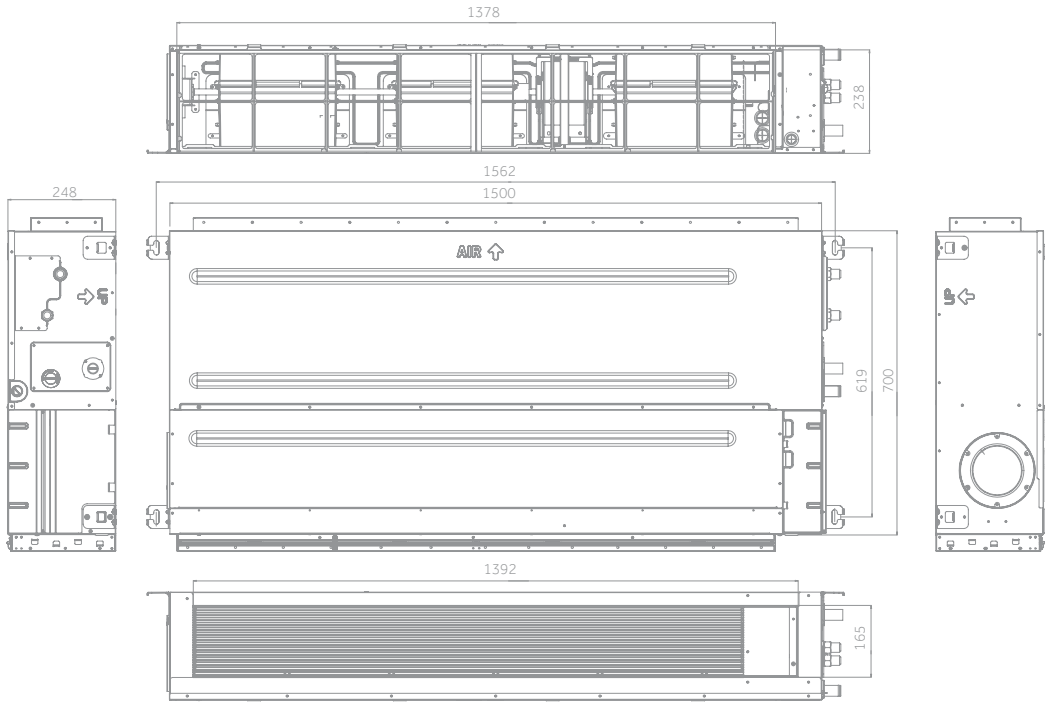

1U140

1U140 - 1U160

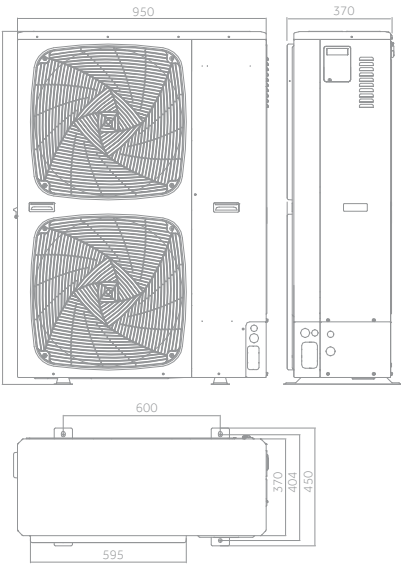
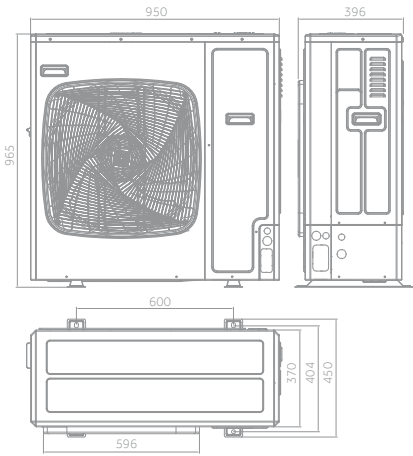

14,0kW - 16,0kW

DUCTED MEDIUM PRESSURE

13,4 kW

16,0 kW

Please see pages 40 & 41
For Controller Options



A+ / A



Silence

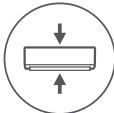

Compact Design



3D



Condensate Drain Pump



Flexible Installation



UVC Sterilisation



Integrated Wi-Fi Control



- Low noise level
- Compact design
- 'Fresh air' knockout is incorporated in the chassis to allow fresh air introduction of up to 20% of nominal unit air flow without compromising the cooling capacity.
- Condensate drain pump
- UCV Sterilisation
- Integrated Wi-Fi control



INDOOR UNIT	Model		AD140S2SM8FA(H)	AD140S2SM8FA(H)	AD140S2SM8FA(H)	AD140S2SM8FA(H)	AD160S2SM3FA(H)
OUTDOOR UNIT	Model		1U140S2SN1FA	1U140S2SN1FB	1U140S2SP2FA	1U140S2SP2FB	1U160S2SP1FB
Performance data							
Output power - COOLING	nom (min-max)	kW	13,40 (3,50-14,00)	13,40 (3,50-14,00)	13,40 (4,00-15,00)	13,40 (4,00-15,00)	16,00 (4,50-16,50)
Output power - HEATING	nom (min-max)	kW	15,00 (4,00-15,50)	15,00 (4,00-15,50)	15,00 (4,50-16,00)	15,00 (4,50-16,00)	17,00 (5,00-18,00)
Absorbed power - COOLING	nom (min-max)	kW	5,28 (1,00-6,50)	5,18 (1,00-6,50)	4,14 (1,00-6,00)	4,15 (1,00-6,00)	5,48 (1,00-6,50)
Absorbed power - HEATING	nom (min-max)	kW	4,92 (1,00-6,50)	4,79 (1,00-6,50)	4,03 (1,00-6,00)	4,02 (1,00-6,00)	4,82 (1,00-6,50)
Energy class	EER	W/W	2,54	2,59	3,24	3,23	2,92
	COP	W/W	3,05	3,13	3,72	3,73	3,53
COOLING Pdesign	35 °C	kW	13,40	13,40	13,40	13,40	16,00
HEATING Pdesign	(-10 °C)	kW	8,50	8,50	11,00	11,00	11,00
Energy class	SEER		5,62 (A+)	5,64 (A+)	6,16 (A++)	6,19 (A++)	5,94 (A+)
	SCOP		3,93 (A)	3,96 (A)	4,06 (A+)	4,06 (A+)	4,06 (A+)
Annual Energy Consumption - COOLING		kWh/a	835	832	761	758	943
Annual Energy Consumption - HEATING		kWh/a	3032	3003	3796	3798	3798
Indoor Unit							
Power supply		Ph/V/Hz	1/220-240/50/60	1/220-240/50/60	1/220-240/50/60	1/220-240/50/60	1/220-240/50/60
Treated air volume	(H/M/L/Q)	m ³ /h	2500/2160/1780/1500	2500/2160/1780/1500	2500/2160/1780/1500	2500/2160/1780/1500	2500/2160/1780/1500
External static pressure		Pa	25/37(default)/50/70/90/100/110/120/130/150				
High sound power		dB	66	66	66	66	67
Sound pressure		dB(A)	48/45/42/39	48/45/42/39	48/45/42/39	48/45/42/39	48/45/42/39
Net dimensions	WxDxH	mm	1500x700x248	1500x700x248	1500x700x248	1500x700x248	1500x700x248
Packaging dimensions	WxDxH	mm	1711x870x325	1711x870x325	1711x870x325	1711x870x325	1711x870x325
Net/gross weight		kg	48,0/57,0	48,0/57,0	48,0/57,0	48,0/57,0	48,0/57,0
Outdoor Unit							
Power supply		Ph/V/Hz	1/220-240/50/60	3/380-415/50/60	1/220-240/50/60	3/380-415/50/60	3/380-415/50/60
Power cable		N x mm ²	3 x 6,0	5 x 4,0	3 x 6,0	5 x 4,0	5 x 4,0
Interconnection cable		N x mm ²	4 x 2,5	4 x 2,5	4 x 2,5	4 x 2,5	4 x 2,5
Sound power	H	dB	72	72	70	70	72
Sound pressure	H	dB(A)	58	58	53	53	58
Running current cooling/heating	Max	A	30,0	10,0	32,0	10,0	10,0
Starting current cooling/heating	Max	A	5,0	2,0	6,0	2,0	2,0
Net dimensions	WxDxH	mm	950x370x965	950x370x965	950x370x1350	950x370x1350	950x370x1350
Packaging dimensions	WxDxH	mm	1050x485x1130	1050x485x1130	1050x485x1500	1050x485x1500	1050x485x1500
Net/gross weight		kg	84,0/89,0	85,0/90,0	105,0/118,0	101,0/116,0	101,0/116,0
Compressor type			Twin rotary inverter	Twin rotary inverter	Twin rotary inverter	Twin rotary inverter	Twin rotary inverter
Installation data							
Refrigerant			R32	R32	R32	R32	R32
Liquid pipe	Ø	mm (inch)	9,52 (3/8)	9,52 (3/8)	9,52 (3/8)	9,52 (3/8)	9,52 (3/8)
Gas pipe	Ø	mm (inch)	15,88 (5/8)	15,88 (5/8)	15,88 (5/8)	15,88 (5/8)	19,05 (3/4)
Standard pipe length without refrigerant charge		m	30	30	30	30	30
Maximum pipe length		m	70	70	70	70	70
Maximum IU - OU elevation		m	30	30	30	30	30
Refrigerant charge in the factory		kg	2,30	2,30	2,90	3,50	3,50
Refrigerant charge in the factory		TCO ₂ eq	1,55	1,55	1,96	2,36	2,36
Additional ref. charge over std length		g/m	45	45	45	45	60
Outdoor operating limits - COOLING	min-max	°C	-20-46				
Outdoor operating limits - HEATING	min-max	°C	-20-24				

DUCTED HIGH PRESSURE



DUCTED HIGH PRESSURE

FRESH AIR

Air exchange allows introduction of clean air into the room.



WI-FI (OPTIONAL)

Allows you to set the air conditioner remotely
Wi-Fi connection is possible with HI-WB201DEI module.



GREATER RANGE

The indoor unit can hold up to 3 fans so that air flow can be supplied evenly across the different ESPs, further increasing comfort.

210PA PRESSURE SETTING

The 210Pa ducted unit with 10 configurable steps allows for high design flexibility, thus meeting the duct installation requirements.

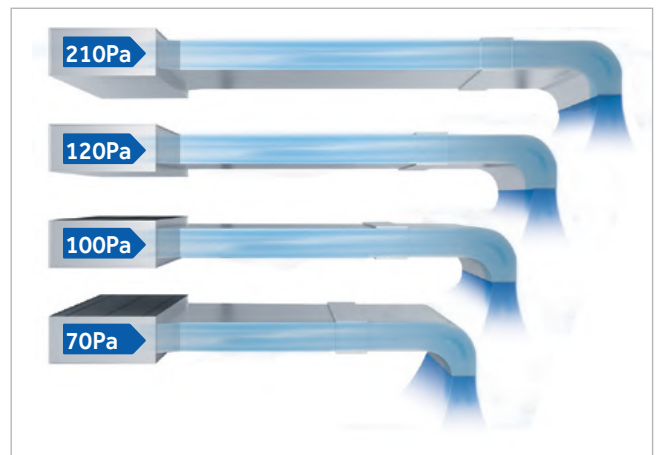

Flexible air distribution

The ducted units satisfy multiple installation solutions (circular or rectangular channels).

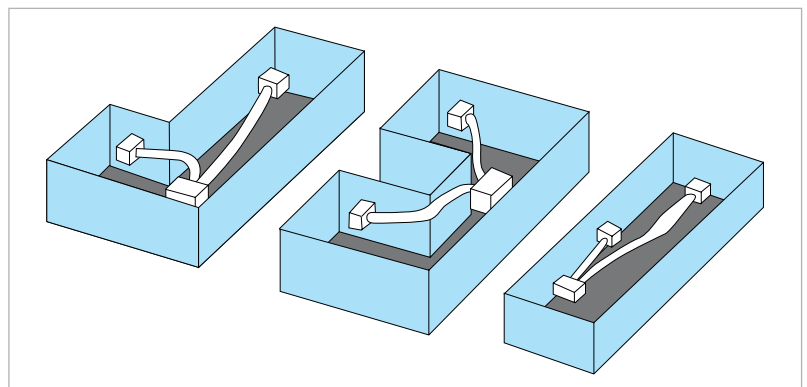

EASY INSTALLATION: PRESSURE ADJUSTABLE IN 10 STEPS

The pressure can be adjusted directly from the YR-E16B / HW-SA201ABK remote controller.



DUCTED HIGH PRESSURE



ADH125

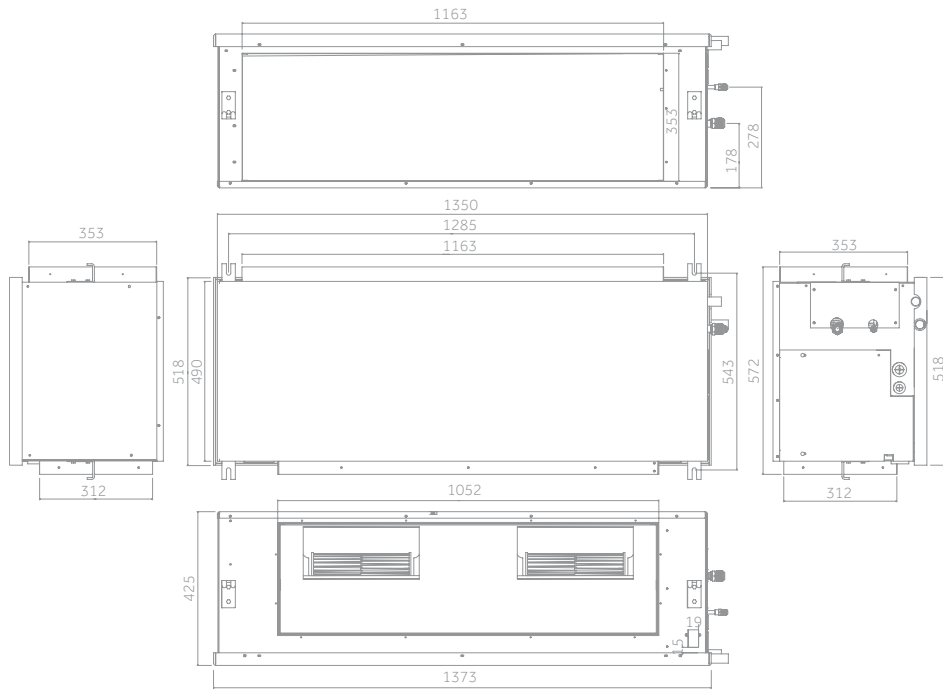

1U125

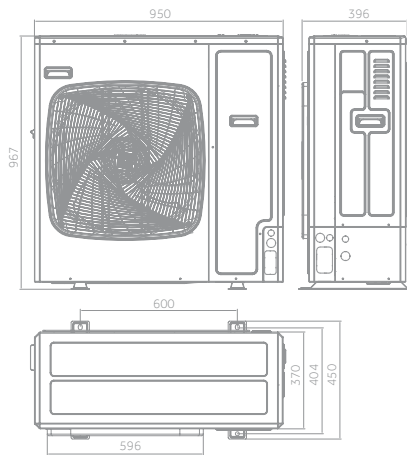

12,5

DUCTED HIGH PRESSURE



A+ / A

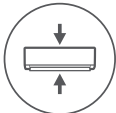

Silence

Compact
Design

Fresh Air



On-Off Card



- Low noise level
- Compact design
- 'Fresh air' knockout is incorporated in the chassis to allow fresh air introduction of up to 20% of nominal unit air flow without compromising the cooling capacity. More than 20% of the air conditioner's thermal cooling capacity is penalise
- Condensate drain by gravity - drain pump not provided

Indoor Unit	Model		ADH125H1ERG	ADH125H1ERG
Outdoor Unit	Model		1U125S2SN2FA	1U125S2SN2FB
Performance data				
Output power - COOLING	nom (min-max)	kW	12,30 (3,00-13,00)	12,40 (3,00-13,00)
Output power - HEATING	nom (min-max)	kW	12,70 (3,50-13,50)	12,80 (3,50-13,50)
Absorbed power – COOLING	nom (min-max)	kW	4,47 (1,00-6,00)	4,56 (1,00-6,00)
Absorbed power – HEATING	nom (min-max)	kW	3,74 (1,00-6,00)	3,73 (1,00-6,00)
Energy class	EER	W/W	2,75	2,72
	COP	W/W	3,40	3,43
COOLING Pdesign	35 °C	kW	12,30	12,40
HEATING Pdesign	(-10 °C)	kW	8,00	8,00
Energy class	SEER		5,80 (A+)	5,90 (A+)
	SCOP		3,94 (A)	3,97 (A)
Annual Energy Consumption - COOLING		kWh/a	713/745	700
Annual Energy Consumption - HEATING		kWh/a	3022	2998
Indoor Unit				
Power supply		Ph/V/Hz	1/220-240/50/60	1/220-240/50/60
Treated air volume	(H/M/L/Q)	m3/h	3250/2750/2250/1750	3250/2750/2250/1750
External static pressure		Pa	37/50(default)/70/90/110 /130/150/170/190/210	37/50(default)/70/90/110 /130/150/170/190/210
High sound power		dB	64	64
Sound pressure		dB(A)	47/44/42/39	47/44/42/39
Net dimensions	WxDxH	mm	1350x490x425	1350x490x425
Packaging dimensions	WxDxH	mm	1565x724x510	1565x724x510
Net/gross weight		kg	61,0/72,0	61,0/72,0
Outdoor Unit				
Power supply		Ph/V/Hz	1 /220-240/ 50/60	3 /380-415/ 50/60
Power cable		N x mm2	3 x 6,0	5 x 4,0
Interconnection cable		N x mm2	4 x 2,5	4 x 2,5
Sound power	H	dB	72	72
Sound pressure	H	dB(A)	58	58
Running current cooling/heating	Max	A	26,0	10,0
Starting current cooling/heating	Max	A	4,0	2,0
Net dimensions	WxDxH	mm	950x370x965	950x370x965
Packaging dimensions	WxDxH	mm	1050x485x1130	1050x485x1130
Net/gross weight		kg	84,0/89,0	85,0/90,0
Compressor type			Twin rotary inverter	Twin rotary inverter
Installation data				
Refrigerant			R32	R32
Liquid pipe	∅	mm (inch)	9,52 (3/8)	9,52 (3/8)
Gas pipe	∅	mm (inch)	15,88 (5/8)	15,88 (5/8)
Standard pipe length without refrigerant charge		m	30	30
Maximum pipe length		m	50	50
Maximum IU - OU elevation		m	30	30
Refrigerant charge in the factory		kg	2,30	2,30
Refrigerant charge in the factory		TCO2eq	1,55	1,55
Additional ref. charge over std length		g/m	45	45
Outdoor operating limits - COOLING	min-max	°C		-20-46
Outdoor operating limits - HEATING	min-max	°C		-20-24

DUCTED HIGH PRESSURE



ADH140 - ADH160

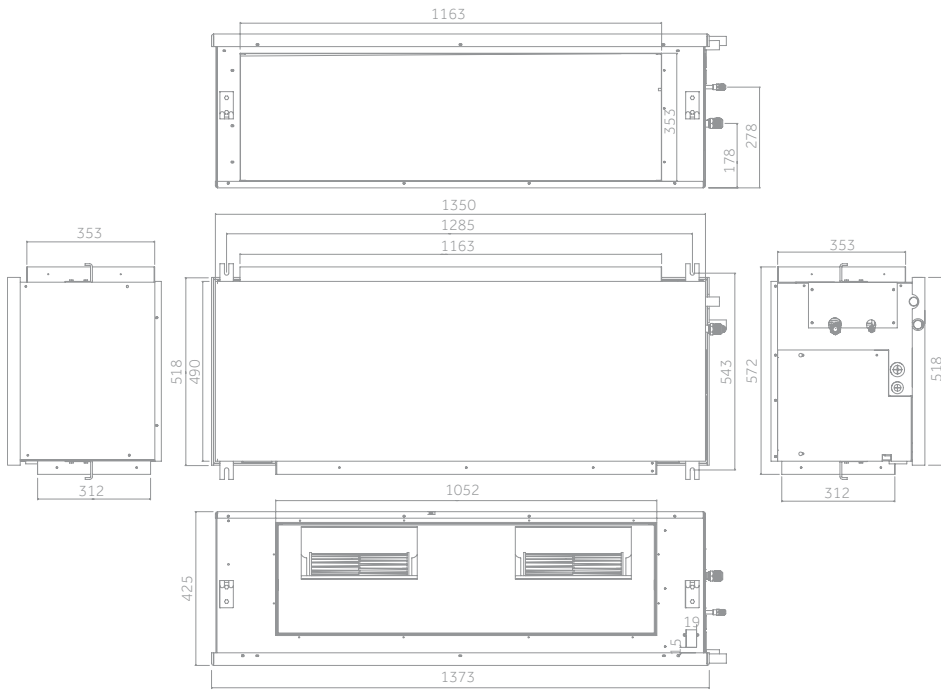

1U140

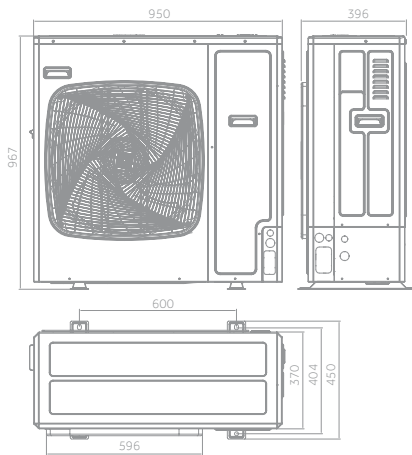

1U140 - 1U160

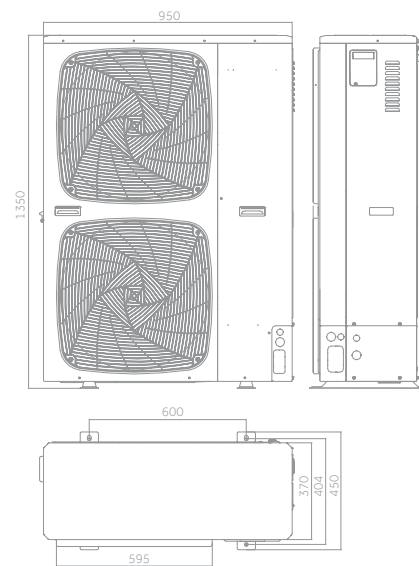

14,0kW



14,0kW - 16,0kW

DUCTED HIGH PRESSURE

Haier

13,6 kW

16,0 kW

Please see pages 40 & 41
For Controller Options

MONOSPLIT



A+ / A



Silence

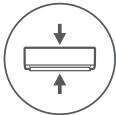

Compact Design



Fresh Air

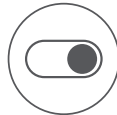

On-Off Card



- Low noise level
- Compact design
- 'Fresh air' knockout is incorporated in the chassis to allow fresh air introduction of up to 20% of nominal unit air flow without compromising the cooling capacity. More than 20% of the air conditioner's thermal cooling capacity is penalise
- Condensate drain by gravity - drain pump not provided

INDOOR UNIT	Model		ADH140H1ERG	ADH140H1ERG	ADH140H1ERG	ADH140H1ERG	ADH160H1ERG*
OUTDOOR UNIT	Model		1U140S2SN1FA	1U140S2SN1FB	1U140S2SP2FA	1U140S2SP2FB	1U160S2SP1FB*
Performance data							
Output power - COOLING	nom (min-max)	kW	13,40 (3,50-14,00)	13,40 (3,50-14,00)	13,60 (4,00-15,00)	13,60 (4,00-15,00)	15,0 (4,5-16,0)
Output power - HEATING	nom (min-max)	kW	15,00 (4,00-15,50)	15,00 (4,00-15,50)	15,00 (4,50-16,00)	15,00 (4,50-16,00)	16,0 (5,0-17,0)
Absorbed power - COOLING	nom (min-max)	kW	4,75 (1,00-6,50)	4,59 (1,00-6,50)	4,24 (1,00-6,00)	4,22 (1,00-6,00)	6,0 (1,8-6,4)
Absorbed power - HEATING	nom (min-max)	kW	4,53 (1,00-6,50)	4,37 (1,00-6,50)	4,04 (1,00-6,00)	4,02 (1,00-6,00)	6,4 (1,6-5,48)
Energy class	EER	W/W	2,82	2,92	3,21	3,22	2,5
	COP	W/W	3,31	3,43	3,71	3,73	3,1
COOLING Pdesign	35 °C	kW	13,40	13,40	13,60	13,60	15,0
HEATING Pdesign	(-10 °C)	kW	8,50	8,50	10	10	11,0
Energy class	SEER		5,84 (A+)	5,98 (A+)	6,16 (A++)	6,18 (A++)	5,6 (A+)
	SCOP		3,94 (A)	3,97 (A)	4,07 (A+)	4,10 (A+)	4,0 (A+)
Annual Energy Consumption - COOLING		kWh/a	803	785	761	759	880
Annual Energy Consumption - HEATING		kWh/a	3022	2998	3786	3754	3859
Indoor Unit							
Power supply		Ph/V/Hz	1/220-240/50/60	1/220-240/50/60	1/220-240/50/60	1/220-240/50/60	1/220-240/50/60
Treated air volume	(H/M/L/Q)	m ³ /h	3600/3100/2600/2100	3600/3100/2600/2100	3600/3100/2600/2100	3600/3100/2600/2100	4000/3400/2800/2200
External static pressure		Pa	37/50(default)/70/90/110/130/150/170/190/210				
High sound power		dB	65	65	65	65	67
Sound pressure		dB(A)	49/46/43/40	49/46/43/40	49/46/43/40	49/46/43/40	50/47/45/42
Net dimensions	WxDxH	mm	1350x490x425	1350x490x425	1350x490x425	1350x490x425	1350x490x425
Packaging dimensions	WxDxH	mm	1565x724x510	1565x724x510	1565x724x510	1565x724x510	1565x724x510
Net/gross weight		kg	61,0/72,0	61,0/72,0	61,0/72,0	61,0/72,0	61/72
Outdoor Unit							
Power supply		Ph/V/Hz	1/220-240/50/60	3/380-415/50/60	1/220-240/50/60	3/380-415/50/60	3/380-415/50/60
Power cable		N x mm ²	3 x 6,0	5 x 4,0	3 x 6,0	5 x 4,0	5 x 4,0
Interconnection cable		N x mm ²	4 x 2,5	4 x 2,5	4 x 2,5	4 x 2,5	4 x 2,5
Sound power	H	dB	72	72	70	70	74
Sound pressure	H	dB(A)	58	58	53	53	58
Running current cooling/heating	Max	A	30,0	10,0	32,0	10,0	10,0
Starting current cooling/heating	Max	A	5,0	2,0	6,0	2,0	2,0
Net dimensions	WxDxH	mm	950x370x965	950x370x965	950x370x1350	950x370x1350	950x370x1350
Packaging dimensions	WxDxH	mm	1050x485x1130	1050x485x1130	1050x485x1500	1050x485x1500	1050x485x1500
Net/gross weight		kg	84,0/89,0	85,0/90,0	105,0/118,0	101,0/116,0	101/116
Compressor type			Twin rotary inverter	Twin rotary inverter	Twin rotary inverter	Twin rotary inverter	Twin Rotary Inverter
Installation data							
Refrigerant			R32	R32	R32	R32	R32
Liquid pipe	Ø	mm (inch)	9,52 (3/8)	9,52 (3/8)	9,52 (3/8)	9,52 (3/8)	9,52 (3/8)
Gas pipe	Ø	mm (inch)	15,88 (5/8)	15,88 (5/8)	15,88 (5/8)	15,88 (5/8)	19,05 (3/4)
Standard pipe length without refrigerant charge		m	30	30	30	30	30
Maximum pipe length		m	70	70	70	70	70
Maximum IU - OU elevation		m	30	30	30	30	30
Refrigerant charge in the factory		kg	2,30	2,30	2,90	3,50	3,5
Refrigerant charge in the factory		TCO2eq	1,55	1,55	1,96	2,36	2,36
Additional ref. charge over std length		g/m	45	45	45	45	60
Outdoor operating limits - COOLING	min-max	°C	-20-46				
Outdoor operating limits - HEATING	min-max	°C	-20-24				

DUCTED HIGH PRESSURE R410A



ADH200 - ADH250

1UH200 - 1UH250

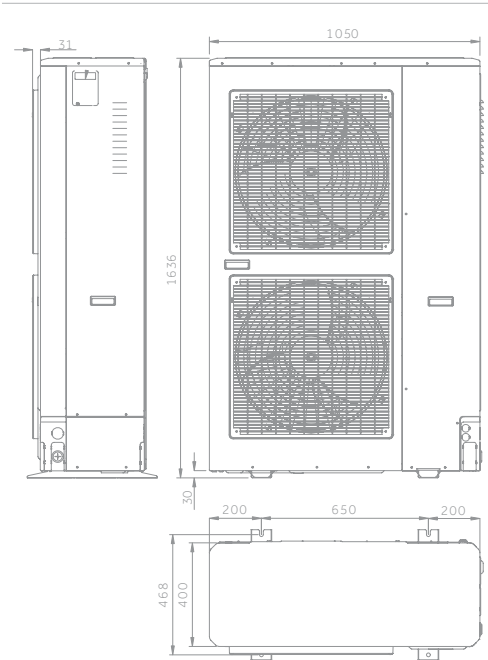
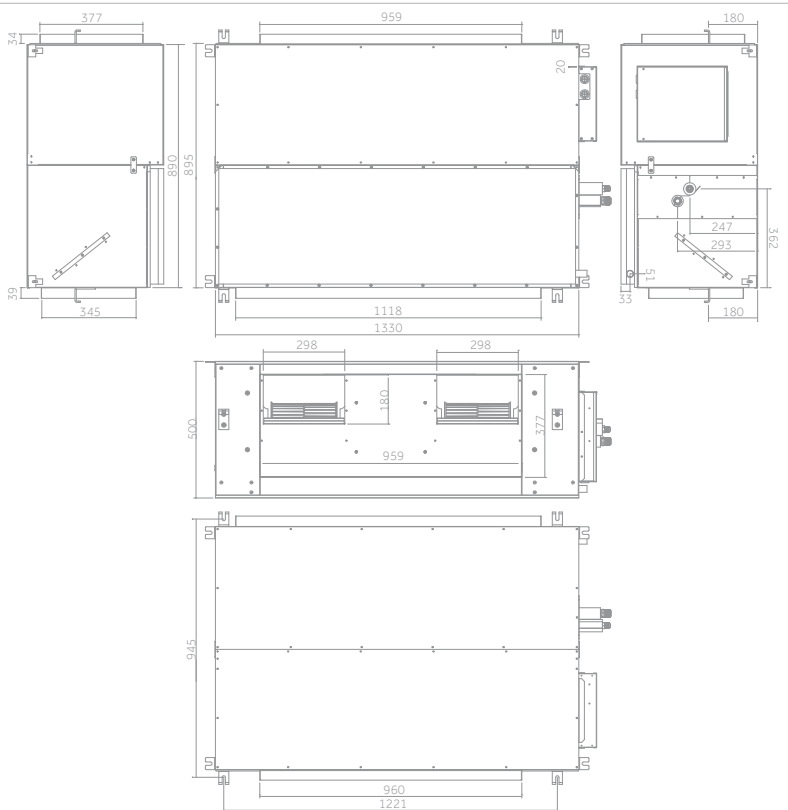

20.0kW - 25.0kW

DUCTED HIGH PRESSURE R410A

20.5 kW

24.0 kW

Please see pages 40 & 41
For Controller Options

A++ / A+

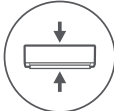

Silence

Compact
Design

Fresh Air



On-Off Card

- Low noise level
- Compact design
- 'Fresh air' knockout is incorporated in the chassis to allow fresh air introduction of up to 20% of nominal unit air flow without compromising the cooling capacity. More than 20% of the air conditioner's thermal cooling capacity is penalised
- Condensate drain by gravity - drain pump not provided

INDOOR UNIT	Model		ADH200H1ERG	ADH250H1ERG
OUTDOOR UNIT	Model		1UH200W1ERK	1UH250W1ERK
Performance data				
Output power - COOLING	nom (min-max)	kW	20,5 (6,2 - 23,5)	24,0 (7,2 - 26,5)
Output power - HEATING	nom (min-max)	kW	22,8 (7,2 - 24,8)	26,8 (8,2 - 28,8)
Absorbed power - COOLING	nom (min-max)	kW	6,1 (2,5 - 8,5)	7,47 (3,5 - 9,5)
Absorbed power - HEATING	nom (min-max)	kW	6,0 (2,5 - 8,5)	7,18 (3,5 - 9,5)
Energy class	EER	W/W	3,36	3,21
	COP	W/W	3,8	3,73
COOLING Pdesign	35 °C	kW	20	24
HEATING Pdesign	(-10 °C)	kW	17	21
Energy class	SEER		6,1 (A++)	6,1 (A++)
	SCOP		4 (A+)	4 (A+)
Annual Energy Consumption - COOLING		kWh/a	/	/
Annual Energy Consumption - HEATING		kWh/a	/	/
Indoor Unit				
Power supply		Ph/V/Hz	1/220-230/50/60	1/220-230/50/60
Treated air volume	(H/M/L/Q)	m ³ /h	4320/3780/3420/3060	5040/4500/3960/3600
External static pressure		Pa	62/90/110/130/150/170/190/ 210/230/250	62/90/110/130/150/170/190/ 210/230/250
High sound power		dB	68	69
Sound pressure		dB(A)	45/50/54	47/51/55
Net dimensions	WxDxH	mm	1330x895x500	1330x895x500
Packaging dimensions	WxDxH	mm	1510x1037x568	1510x1037x568
Net/gross weight		kg	96	96
Outdoor Unit				
Power supply		Ph/V/Hz	3/380-400/50/60	3/380-400/50/60
Power cable		N x mm ²	5 x 4,0	5 x 4,0
Interconnection cable		N x mm ²	4 x 2,5	4 x 2,5
Sound power	H	dB	75	75
Sound pressure	H	dB(A)	58	58
Running current cooling/heating	Max	A	15,3/15,3	15,3/15,3
Starting current cooling/heating	Max	A	3,0/ 3,0	3,0/ 3,0
Net dimensions	WxDxH	mm	1636x1050x400	1636x1050x400
Packaging dimensions	WxDxH	mm	1050x485x1130	1050x485x1130
Net/gross weight		kg	160	160
Compressor type			Twin Rotary	Twin Rotary
Installation data				
Refrigerant			R410A	R410A
Liquid pipe	∅	mm (inch)	12,70 (1/2)	12,70 (1/2)
Gas pipe	∅	mm (inch)	19,05 (3/4)	22,22 (7/8)*
Standard pipe length without refrigerant charge		m	30	30
Maximum pipe length		m	75	75
Maximum IU - OU elevation		m	30	30
Refrigerant charge in the factory		kg	6,10	6,10
Refrigerant charge in the factory		TCO ₂ eq	13,25	13,25
Additional ref. charge over std length		g/m	80	80
Outdoor operating limits - COOLING	min-max	°C		-10-46
Outdoor operating limits - HEATING	min-max	°C		-15-24

*A 19.05 mm flare socket must be used and welded to the 22.22 mm gas pipe to connect the unit to the gas pipe. The nozzle is not supplied with the unit.

The data in this catalogue is purely indicative as the data may vary. Please be advised to check the accuracy of the data with the supplier before purchasing products.



FEATURES AND FUNCTIONS

This Kit can be used to integrate the 3rd party AHU into Haier Super Match single split series. The main features and functions include:

- Capacity range: 2.5KW-16KW. Capacity can be changed by Dip switch
- Receive 0-10V signal from AHU (Field supplied)
- Outdoor unit capacity control based on the 0-10V signal
- To meet the target room temperature through the outdoor capacity control based on the 0-10V signal
- On/off Operation, Cooling/Heating mode selection
- Defrost signal output

AHU SOLUTION NEW

FEATURES AND FUNCTIONS

- Anti-cold air function when outdoor unit conducts defrost
- Error info. output
- IP 44 waterproof certification, which makes outdoor installation possible

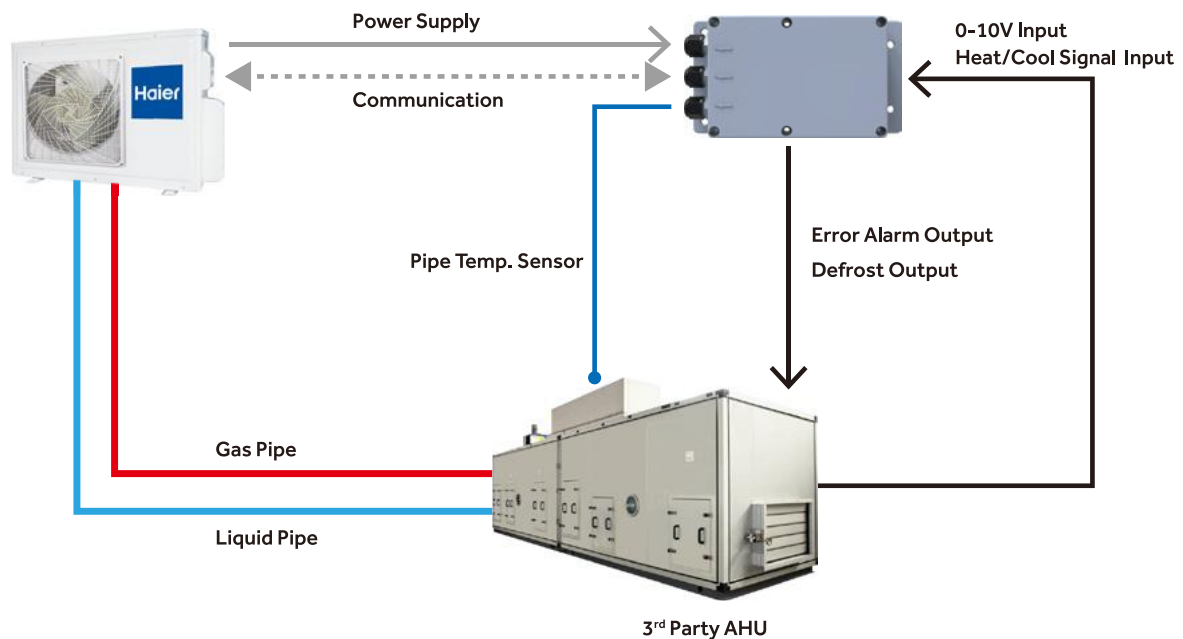

SPECIFICATION

MODEL	AH1-LCAC1	AH1-RAC1
Power Supply(Ph/V/Hz)	1 Phase/220~240V/50/60Hz	1 Phase/220~240V/50/60Hz
Dimension (W/D/H)mm	206/52.5/110	206/52.5/110
Package Dimension (W/D/H)mm	240/80/120	240/80/120
Colour	Grey	Grey
Weight(KG)	0.4	0.4
Shipping Weight(KG)	0.6	0.6

COMPATIBILITY

MODEL	Products	AH1-LCAC1	AH1-RAC1
 <p>R32 Match Plus Heat Pump</p>	1U25S2SM1FA-2		●
	1U35S2SM1FA-2		●
	1U42S2SM1FA		●
	1U50S2SJ2FA-2		●
	1U71S2ST1FA	●	
	1U105S2SS1FA	●	
	1U105S2SS2FA	●	
	1U105S2SS1FB	●	
	1U125S2SN2FA	●	
	1U125S2SN2FB	●	
	1U140S2SN1FA	●	
	1U140S2SN1FB	●	
	1U140S2SP2FA	●	
	1U140S2SP2FB	●	
	1U160S2SP1FB	●	



AP71

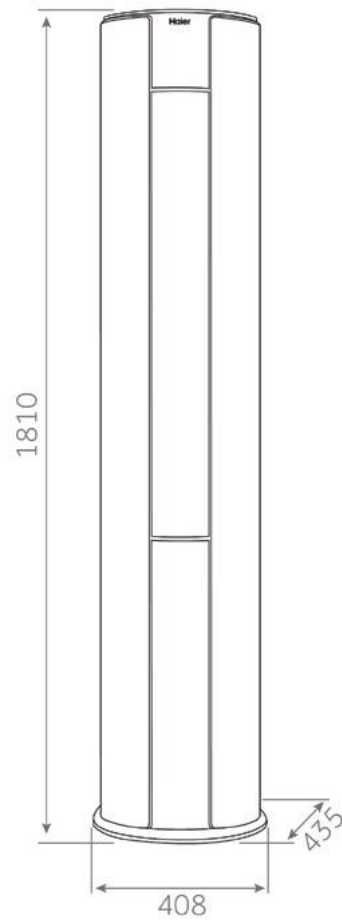

1U71

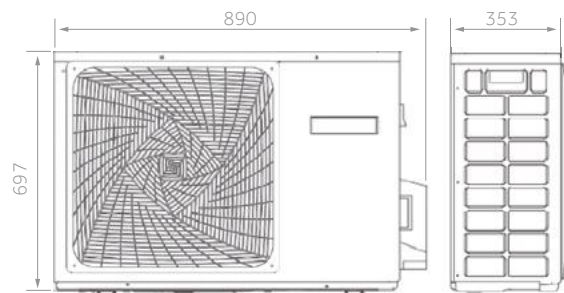

7,1kW

TOWER NEW

Estimated Launch Date July 2024

A++ / A+

7,1 kW



Standard YR-HQ



Silence



3D



Sleep

Integrated
Wi-Fi Control

WHITE

- Low noise level
- 3D airflow: continuous movement of horizontal and vertical deflectors
- Sleep function for greater night time comfort
- Integrated Wi-Fi control

INDOOR UNIT	Model		AP71DFMHRA
OUTDOOR UNIT	Model		1U71WEMFRA
Performance data			
Output power - COOLING	nom (min-max)	kW	7,2 (0,90-8,90)
Output power - HEATING	nom (min-max)	kW	8 (0,90-10,50)
Absorbed power - COOLING	nom (min-max)	kW	2,23 (0,12-2,8)
Absorbed power - HEATING	nom (min-max)	kW	2,15(0,19-2,8)
Energy class	EER	W/W	3,23
	COP	W/W	3,70
COOLING Pdesign	35 °C	kW	7,20
HEATING Pdesign	(-10 °C)	kW	5,50
Energy class	SEER		7,00 (A++)
	SCOP		4,00 (A+)
Annual Energy Consumption - COOLING		kWh/a	360
Annual Energy Consumption - HEATING		kWh/a	1925
Indoor Unit			
Power supply		Ph/V/Hz	1PH/220-240V/50Hz
Treated air volume	H	m ³ /h	1510
Dehumidification		L/h	4,25
High sound power - COOLING		dB	64
High sound power - HEATING		dB	64
Sound pressure - COOLING		dB(A)	47
Sound pressure -HEATING		dB(A)	47
Net dimensions	WxDxH	mm	408x435x1810
Packaging dimensions	WxDxH	mm	525x550x1940
Net/gross weight		kg	26,5/34,5
Outdoor Unit			
Power supply		Ph/V/Hz	1PH/220-240V/50Hz
Power cable		N x mm ²	3 x 4,0
Interconnection cable		N x mm ²	4 x 1,5
Sound power	H	dB	69
Sound pressure	H	dB(A)	56
Running current cooling/heating	Max	A	14,5/17,5
Starting current cooling/heating	Max	A	2,0/2,0
Net dimensions	WxDxH	mm	889x340x705
Packaging dimensions	WxDxH	mm	1046x460x780
Net/gross weight		kg	43,5/47,5
Compressor type			Twin rotary inverter
Installation data			
Refrigerant			R32
Liquid pipe	∅	mm (inch)	6,35(1/4)
Gas pipe	∅	mm (inch)	12,7(1/2)
Standard pipe length without refrigerant charge		m	5
Maximum pipe length		m	20
Maximum IU - OU elevation		m	15
Refrigerant charge in the factory		kg	1,50
Refrigerant charge in the factory		TCO ₂ eq	1,01
Additional ref. charge over std length		g/m	20
Operating limits - COOLING (in/out)	min-max	°C	21 35/ -20-43
Operating limits - HEATING (in/out)	min-max	°C	10-27/ -25-24



AP105 - AP140 - AP160

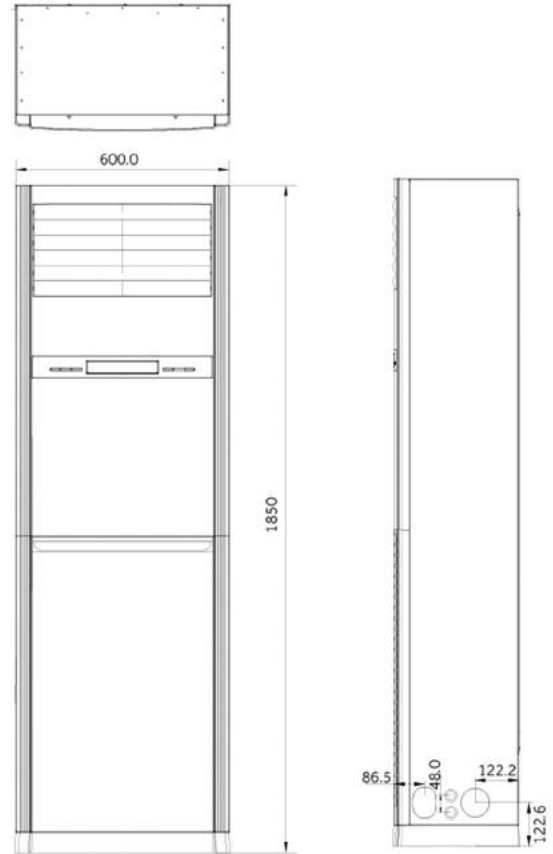

1U105

1U140

1U160

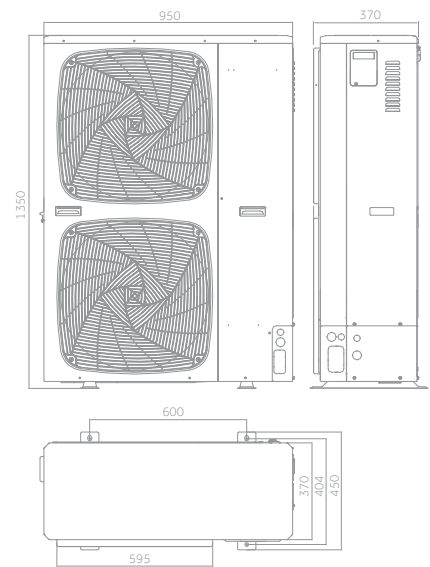
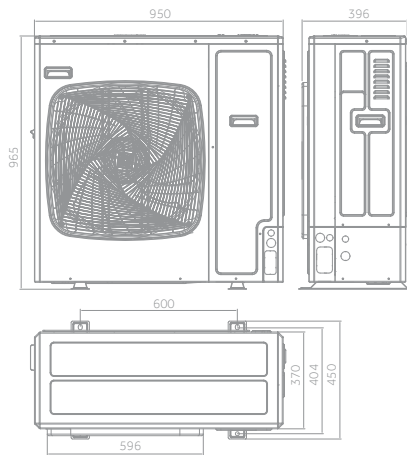
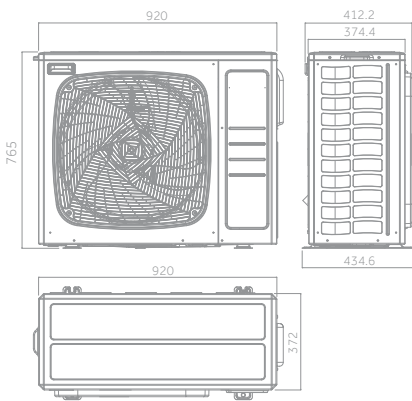

10,5 kW



14,0 kW



16,0 kW

CABINET NEW

Haier

MONOSPLIT



A+ / A

10,5 kW

13,4 kW

15,0 kW

Please see pages 40 & 41
For Controller Options



YR-HRS01



Silence



3D



Auto Mode



Auto Restart



UVC
Sterilisation



Integrated
Wi-Fi Control

- Low sound level
- 3D airflow: horizontal and vertical louver movement
- Auto mode
- Auto restart
- UVC Sterilisation
- Integrated Wi-Fi control

INDOOR UNIT	Model		AP105S2SK1FA(H)	AP140S2SK1FA(H)	AP140S2SK1FA(H)	AP160S2SK1FA(H)
OUTDOOR UNIT	Model		1U105S2SS2FA	1U140S2SN1FA	1U140S2SN1FB	1U160S2SP1FB
Performance data						
Output power - COOLING	nom (min-max)	kW	9,20 (2,50-10,00)	13,40 (3,50-14,00)	13,40 (3,50-14,00)	15,0 (4,5-16,0)
Output power - HEATING	nom (min-max)	kW	10,00 (3,00-10,50)	15,00 (4,00-15,50)	15,00 (4,00-15,50)	16,0 (5,0-17,0)
Absorbed power - COOLING	nom (min-max)	kW	3,1 (0,50-4,00)	5,83 (1,00-6,50)	5,40 (1,00-6,50)	6,0 (1,8-6,4)
Absorbed power - HEATING	nom (min-max)	kW	2,9 (0,50-4,00)	5,45 (1,00-6,50)	5,43 (1,00-6,50)	6,4 (1,6-5,48)
Energy class	EER	W/W	3,00	2,30	2,48	2,5
	COP	W/W	3,5	2,75	2,76	3,1
COOLING Pdesign	35 °C	kW	9,20	13,40	13,40	15,0
HEATING Pdesign	(-10 °C)	kW	7,50	8,50	8,50	11,0
Energy class	SEER		6,00 (A++)	5,60 (A+)	5,66 (A+)	5,6 (A+)
	SCOP		4,1 (A+)	3,93 (A)	3,95 (A)	4,0 (A+)
Annual Energy Consumption - COOLING		kWh/a	531	837	829	880
Annual Energy Consumption - HEATING		kWh/a	2523	3018	3012	3859
Indoor Unit						
Power supply		Ph/V/Hz	1/220-240/50/60	1/220-240/50/60	1/220-240/50/60	1/220-240/50/60
Treated air volume	(H/M/L/Q)	m ³ /h	1580/1450/1350	1850/1500/1350	1850/1500/1350	1850/1500/1350
High sound power		dB	63	65	65	67
Sound pressure		dB(A)	50/45/42	52/49/46	52/49/46	52/49/46
Net dimensions	WxDxH	mm	600x350x1850	600x350x1850	600x350x1850	600x350x1850
Packaging dimensions	WxDxH	mm	693x438x2035	693x438x2035	693x438x2035	693x438x2035
Net/gross weight		kg	50,0/61,0	50,0/61,0	50,0/61,0	50,0/61,0
Outdoor Unit						
Power supply		Ph/V/Hz	1/220-240/50/60	1/220-240/50/60	3/380-415/50/60	3/380-415/50/60
Power cable		N x mm ²	3 x 4,0	3 x 6,0	5 x 4,0	5 x 4,0
Interconnection cable		N x mm ²	4 x 2,5	4 x 2,5	4 x 2,5	4 x 2,5
Sound power	H	dB	66	72	72	74
Sound pressure	H	dB(A)	53	58	58	58
Running current cooling/heating	Max	A	16,5	30,0	10,0	10,0
Starting current cooling/heating	Max	A	3,0	5,0	2,0	2,0
Net dimensions	WxDxH	mm	920x372x765	950x370x965	950x370x965	950x370x1350
Packaging dimensions	WxDxH	mm	1036x478x820	1050x485x1130	1050x485x1130	1050x485x1500
Net/gross weight		kg	60,0/65,0	84,0/89,0	85,0/90,0	101/116
Compressor type			Twin rotary inverter	Twin rotary inverter	Twin rotary inverter	Twin rotary inverter
Installation data						
Refrigerant			R32	R32	R32	R32
Liquid pipe	∅	mm (inch)	9,52 (3/8)	9,52 (3/8)	9,52 (3/8)	9,52 (3/8)
Gas pipe	∅	mm (inch)	15,88 (5/8)	15,88 (5/8)	15,88 (5/8)	19,05 (3/4)
Standard pipe length without refrigerant charge		m	30	30	30	30
Maximum pipe length		m	50	70	70	70
Maximum IU - OU elevation		m	30	30	30	30
Refrigerant charge in the factory		kg	1,7	2,30	2,30	3,5
Refrigerant charge in the factory		TCO2eq	1,15	1,55	1,55	2,36
Additional ref, charge over std length		g/m	45	45	45	60
Outdoor operating limits - COOLING	min-max	°C			-20-46	
Outdoor operating limits - HEATING	min-max	°C			-20-24	













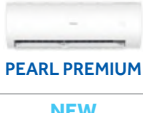

Haier

0000

MULTISPLIT



MULTISPLIT INVERTER

OUTDOOR UNIT R32 MULTISPLIT		1:2		1:3		1:4		1:5			3S	
		2U50S2SM1FA	2U50S2SM1FA-3	3U55S2SR5FA	3U70S2SR5FA	4U75S2SR5FA	4U85S2SR5FA	5U90S2SS5FA	5U10S2SS5FA	5U12S2SN1FA	3U55S2WR1FA	4U70S2WR1FA
INDOOR UNIT R32	kW	4,0 kW	5,0 kW	5,5 kW	7,0 kW	7,5 kW	8,5 kW	9,0 kW	10,5 kW	12,5 kW	5,5 kW	7,0 kW
 JADE SUPERMATCH	2,5	●	●	●	●	●	●	●	●	●	●	●
	3,5	●	●	●	●	●	●	●	●	●	●	●
	5,0			●	●	●	●	●	●	●	●	●
 EXPERT	2,0	●	●	●	●	●	●	●	●	●	●	●
	2,5	●	●	●	●	●	●	●	●	●	●	●
	3,5	●	●	●	●	●	●	●	●	●	●	●
	5,0			●	●	●	●	●	●	●	●	●
	7,1				●	●	●	●	●	●	●	●
 FLEXIS PLUS	2,0	●	●	●	●	●	●	●	●	●	●	●
	2,5	●	●	●	●	●	●	●	●	●	●	●
	3,5	●	●	●	●	●	●	●	●	●	●	●
	5,0			●	●	●	●	●	●	●	●	●
	7,1				●	●	●	●	●	●	●	●
 NEW PEARL PREMIUM	2,0	●	●	●	●	●	●	●	●	●	●	●
	2,5	●	●	●	●	●	●	●	●	●	●	●
	3,5	●	●	●	●	●	●	●	●	●	●	●
	5,0			●	●	●	●	●	●	●	●	●
	6,8				●	●	●	●	●	●	●	●
 NEW REVIVE PLUS	2,5	●	●	●	●	●	●	●	●	●	●	●
	3,5	●	●	●	●	●	●	●	●	●	●	●
	5,0			●	●	●	●	●	●	●	●	●
	6,8				●	●	●	●	●	●	●	●
 CONSOLE	2,5			●	●	●	●	●	●	●	●	●
	3,5			●	●	●	●	●	●	●	●	●
	4,2			●	●	●	●	●	●	●	●	●
 NEW 1 WAY CASSETTE	5,0			●	●	●	●	●	●	●	●	●
	2,5			●	●	●	●	●	●	●	●	●
	3,5			●	●	●	●	●	●	●	●	●
	5,0			●	●	●	●	●	●	●	●	●
 CASSETTE 620	7,1				●	●	●	●	●	●		●
	2,5			●	●	●	●	●	●	●	●	●
	3,5			●	●	●	●	●	●	●	●	●
 CASSETTE ROUND FLOW	5,0			●	●	●	●	●	●	●	●	●
	7,1				●	●	●	●	●	●	●	●
	2,5			●	●	●	●	●	●	●	●	●
 CEILING FLOOR	3,5			●	●	●	●	●	●	●	●	●
	5,0			●	●	●	●	●	●	●	●	●
	7,1				●	●	●	●	●	●	●	●
	2,5			●	●	●	●	●	●	●	●	●
 SLIM DUCT LOW PRESSURE	3,5			●	●	●	●	●	●	●	●	●
	5,0			●	●	●	●	●	●	●	●	●
	7,1				●	●	●	●	●	●	●	●
	2,5			●	●	●	●	●	●	●	●	●
 DUCTED MEDIUM PRESSURE	3,5			●	●	●	●	●	●	●	●	●
	5,0			●	●	●	●	●	●	●	●	●
	7,1				●	●	●	●	●	●	●	●
 NEW 3S TANK	100l										●	●
	200l										●	●

The expressed kW/Btu is for cooling classification. For exact values, see the technical data tables of the individual models.

MULTISPLIT INVERTER

OUTDOOR UNITS MULTISPLIT R32									MULTISPLIT 3S												
4,0 kW	5,0 kW	5,5 Kw	7,0 kW	7,5 kW	8,5 kW	9,0 kW	10,5 kW	12,5kW	5,5kW	7,0kW											
1:2		1:3		1:4		1:5			1:3	1:4											
2U40S2SM1FA		2U50S2SM1FA-3		3U55S2SR5FA		3U70S2SR5FA		4U75S2SR5FA		4U85S2SR5FA		5U90S2SS5FA		5U105S2SS5FA		5U125S2SN1FA		3U55S2WR1FA		4U70S2WR1FA	
Self-clean																					

COMPATIBLE UNITS 1:2

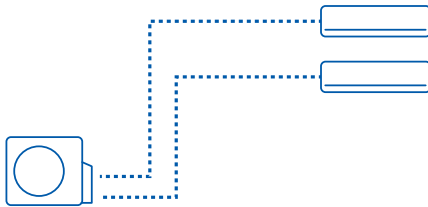

Wall = Wall Only

COMPATIBLE UNITS 1:3

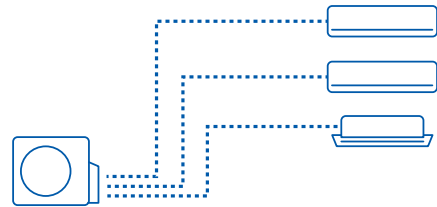

Wall - Cassettes - Floor Ceiling - Console - Ducted

COMPATIBLE UNITS 1:4

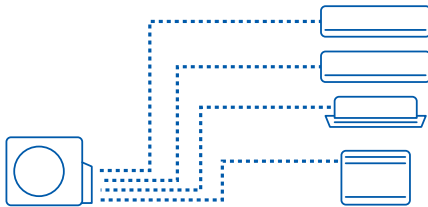

Wall - Cassettes - Floor Ceiling - Console - Ducted

COMPATIBLE UNITS 1:5

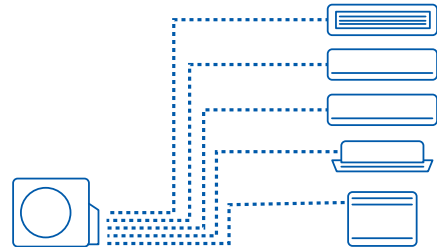

Wall - Cassettes - Floor Ceiling - Console - Ducted

3S COMPATIBLE UNITS 1:3

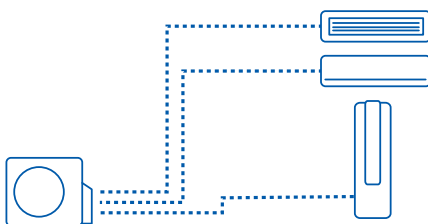

Wall - Cassettes - Floor Ceiling - Console - Ducted - Tanks

3S COMPATIBLE UNITS 1:4

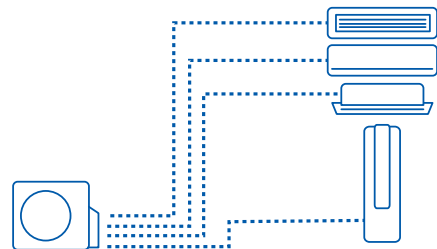

Wall - Cassettes - Floor Ceiling - Console - Ducted - Tanks

MultiSplit OUTDOOR UNITS



1:2 2U40S2SM1FA
2U50S2SM1FA-3



1:3 3U55S2SR5FA
3U70S2SR5FA



1:4 4U75S2SR5FA
4U85S2SR5FA

Outdoor UNIT	Model		2U40S2SM1FA	2U50S2M1FA-3	3U55S2SR5FA	3U70S2SR5FA
Performance data						
Output power - COOLING	nom (min-max)	kW	4,00 (1,10-4,50)	4,60 (1,30-6,00)	5,50 (2,10-7,00)	7,00 (2,40-7,60)
Output power - HEATING	nom (min-max)	kW	4,40 (1,50-4,80)	5,20 (1,60-6,50)	6,80 (1,70-7,60)	7,60 (2,90-8,50)
Absorbed power - COOLING	nom	kW	0,89 (0,30-1,65)	1,07 (0,35-2,01)	1,35	1,84
Absorbed power - HEATING	nom	kW	0,98 (0,38-1,80)	1,21 (0,52-2,00)	1,66	1,85
Energy class	EER	W/W	4,50	4,3	4,00	3,81
	COP	W/W	4,50	4,3	4,10	4,10
COOLING Pdesign	35 °C	kW	4,00	4,60	5,50	7,00
HEATING Pdesign	(-10 °C)	kW	3,70	3,80	4,70	6,00
Energy class	SEER		8,50 (A+++)	8,50 (A+++)	8,50 (A+++)	7,50 (A++)
	SCOP		4,60 (A++)	4,60 (A++)	4,00 (A+)	4,20 (A+)
Annual Energy Consumption - COOLING		kWh/a	165	189	227	332
Annual Energy Consumption - HEATING		kWh/a	1126	1157	1678	2012
Outdoor unit						
Power supply		Ph/V/Hz	1/220-240/50/60			
Power cable		N x mm ²	3 x 2,5	3 x 2,5	3 x 4,0	3 x 4,0
Interconnection cable		N x mm ²	4 x 1,0	4 x 1,0	4 x 2,5	4 x 2,5
Air volume	H	m ³ /h	2200	2400	3000	3000
Sound power	H	dB	62	63	64	66
Sound pressure	H	dB(A)	56	56	51	53
Running current cooling/heating	Max	A	7,4/8,2	9,0/8,9	10,8/9,5	11,9/9,7
Starting current cooling/heating	Max	A	1,0/1,0	1,0/1,0	4,0/4,0	4,0/4,0
Net dimensions	WxDxH	mm	800x280x550	800x280x550	890x340x700	890x340x700
Packaging dimensions	WxDxH	mm	908x405x625	908x405x625	1010x455x835	1010x455x835
Net/gross weight		kg	34,0/37,0	36,0/39,0	50,0/59,0	54,0/63,0
Compressor type			Twin Rotary Inverter			
Installation data						
Refrigerant			R32	R32	R32	R32
Liquid pipe	Ø	mm (inch)	2×6,35 (3x1/4)	2×6,35 (3x1/4)	3×6,35 (3x1/4)	3×6,35 (3x1/4)
Gas pipe	Ø	mm (inch)	2×9,52 (3x3/8)	2×9,52 (3x3/8)	3×9,52 (3x3/8)	3×9,52 (3x3/8)
Standard pipe length without refrigerant charge		m	5	5	30	30
Maximum pipe length		m	20 (single) 30 (double)	20 (single) 30 (double)	50	60
Maximum IU - OU elevation		m	15	15	15	15
Maximum IU - IU elevation		m	7,5	7,5	7,5	7,5
Refrigerant charge in the factory		kg	1,00	1,10	1,40	1,60
Refrigerant charge in the factory		TCO2eq	0,68	0,74	0,95	1,08
Additional ref. charge over std length		g/m	20	20	20	20
Operating limits - COOLING	min-max	°C	-10-43°C		-10-46°C	
Operating limits - HEATING	min-max	°C	-15-24°C			

Data combination based on our Expert Unit. Data can vary with other indoor units.

The data in this catalogue is purely indicative as the data may vary. Please be advised to check the accuracy of the data with the supplier before purchasing products.

4,0 kW

5,0 kW

5,5 Kw

7,0 kW

7,5 kW

8,5 kW

9,0 kW

10,5 kW

12,5 kW



1:5
5U90S2SS5FA
5U105S2SS5FA
5U125S2SN1FA



3S
1:3 3U55S2WR1FA



3S
1:4 4U70S2WR1FA

4U75S2SR5FA	4U85S2SR5FA	5U90S2SS5FA	5U105S2SS5FA	5U125S2SN1FA	3U55S2WR1FA	4U70S2WR1FA
7,50 (2,40-8,70)	8,50 (3,20-9,50)	9,00 (3,20-11,00)	10,00 (3,20-11,00)	12,50 (3,20-13,80)	5,40	7,00
8,60 (3,10-10,00)	9,60 (4,40-10,50)	10,40 (4,40-11,50)	10,50 (4,40-11,50)	12,70 (4,40-14,30)	5,00	6,00
1,97	2,50	2,79	3,47	3,87	1,34	1,8
2,15	2,40	2,79	2,82	3,40	1,68	2,0
3,80	3,40	3,23	2,88	3,23	4,05	3,90
4,00	4,00	3,73	3,73	3,73	4,20	4,30
7,50	8,00	9,00	10,00	12,50	5,4	7,0
6,30	7,00	7,20	8,00	9,50	5,0	6,0
7,00 (A++)	7,00 (A++)	7,00 (A++)	7,00 (A++)	7,10 (A++)	8,5 (A+++)	8 (A++)
4,00 (A+)	4,00 (A+)	4,00 (A+)	4,00 (A+)	4,05 (A+)	4,6 (A++)	4,3 (A+)
379	456	457	537	622	240	320
2179	2503	2441	2889	3346	1680	1922
1/220-240/50/60					1/220-240/50/60	
3 x 4,0	3 x 4,0	3 x 4,0	3 x 4,0	3 x 4,0	3 x 4,0	3 x 4,0
4 x 2,5	4 x 2,5	4 x 2,5	4 x 2,5	4 x 2,5	4 x 2,5	4 x 2,5
4000	4000	4200	4200	4200	3000	3000
68	68	70	70	73	63	63
55	55	55	55	58	53	53
14,7/13,5	15,5/14,6	18,2/14,6	18,2/14,6	23,0/18,7	12,6/11,5	13/12
5,0/5,0	5,0/5,0	5,0/5,0	5,0/5,0	5,0/5,0	4,0/4,0	4,0/4,0
890x340x700	890x340x700	920x372x765	920x372x765	950x370x965	890x340x700	890x340x700
1010x455x835	1010x455x835	1045x488x890	1045x488x890	1050x485x1170	1010x455x875	1010x455x875
61,0/70,0	61,0/70,0	66,0/77,0	66,0/77,0	79,0/91,0	55/65	56/66
Twin Rotary Inverter					Twin Rotary (DC inverter)	
R32	R32	R32	R32	R32	R32	R32
4x6,35 (4x1/4)	4x6,35 (4x1/4)	5x6,35 (5x1/4)	5x6,35 (5x1/4)	5x6,35 (5x1/4)	3*Ø6,35 (3x1/4)	4*Ø6,35 (4x1/4)
3x9,52+1x12,70 (3x3/8+1x1/2)		3x9,52+2x12,70 (3x3/8+2x1/2)			3*Ø9,52 (3x3/8)	4*Ø9,52 (3x3/8)
40	40	40	40	50	30	30
70	70	80	80	100	50	50
15	15	15	15	15	15	15
7,5	7,5	7,5	7,5	7,5	7,5	7,5
1,60	2,20	2,40	2,40	2,50	1,8	1,9
1,08	1,49	1,62	1,62	1,69	1,22	1,28
20	20	20	20	20	20	20
-10-46°C					-10-46°C	
-15-24°C					-15-24°C	

The data in this catalogue is purely indicative as the data may vary. Please be advised to check the accuracy of the data with the supplier before purchasing products.

Data combination based on our Expert Unit. Data can vary with other indoor units.

COMPATIBILITY

Wall Mount						
Jade	Expert	Flexis Plus	Pearl Premium	Revive Plus		

LCAC						
Console	Compact Cassette	Round Way Cassette	1 Way Cassette	Convertible	Slim Duct	Med ESP Ducted

SCENARIOS

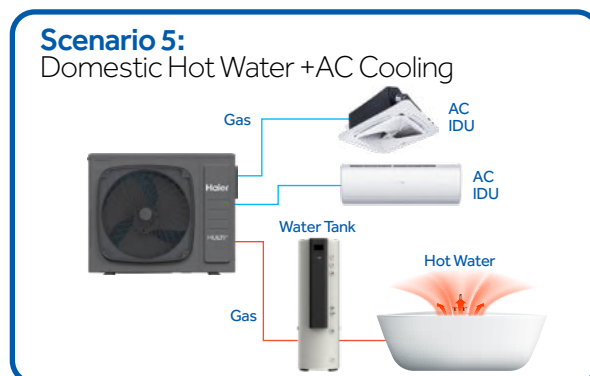
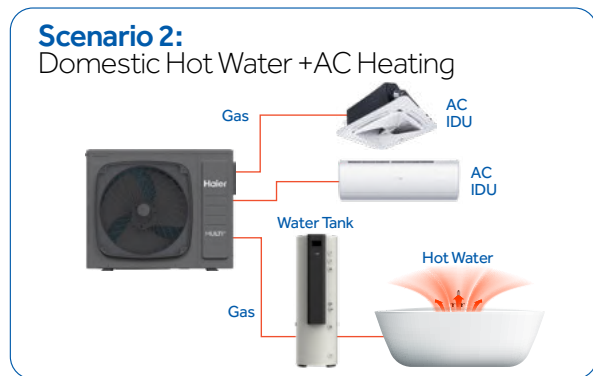
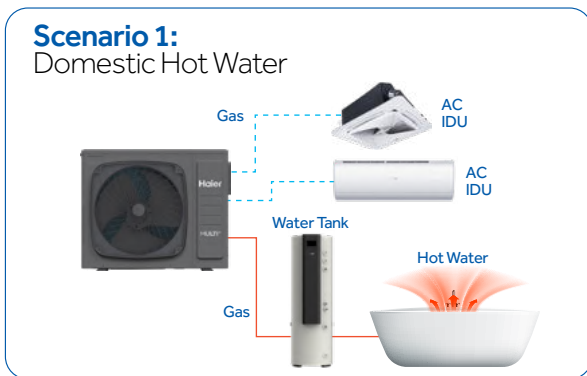

3S TANK NEW

Estimated Launch Date July 2024

Haier

94L

190L

MULTISPLIT



A



Integrated Wi-Fi Control



Easy Installation



Heat Recovery



AC & Domestic Hot Water

- Intergrated Wi-Fi Control
- Easy Installation
- Heat Recovery
- AC & Domestic Hot Water

INDOOR UNIT	Model		AN100S2ST1FA	AN200S2ST1FA
Performance data				
Volume		L	94	190
Max. water Outlet temp.		°C	55 °C (75 °C with electrical heater)	
Electric heater power		W	2,000	
COP average Climate			2,2/ 2,3	2,4/ 2,5
COP warmer Climate			2.7	2.8
Seasonal Efficiency			M	L
Energy Class	EN16147(2017)		A	
Heating Time average Climate		h:mm	2:20/ 2:30	3:10/ 3:20
Heating Time warm Climate		h:mm	2:00/ 2:10	2:50/ 3:00
Power supply		Ph/V/Hz	1/220~240/50/60	
Interconnection cable		N x mm2	2 x 0.75	
Indoor Unit				
Net dimensions	WxDxH	mm	470x560x1110	520x610x1650
Packaging dimensions	WxDxH	mm	730x730x1285	730x730x1825
Net	(gross weight)	kg	45,0 (62,0)	70,0 (88,0)
Material			Enamel	
Installation data				
Liquid pipe	∅	mm	6,35 (1/4)	6,35 (1/4)
Gas pipe	∅	mm	9,52 (3/8)	9,52 (3/8)
Control				
Standard			Integrated	

AN100S2ST1FA

AN200S2ST1FA

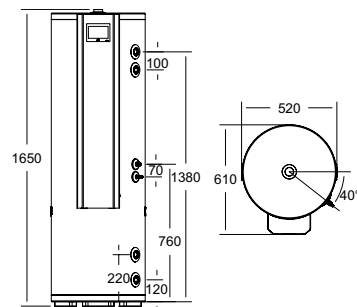
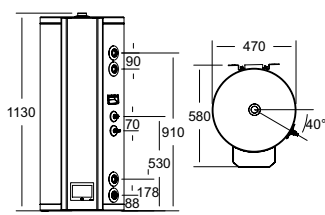



Standard HQ-HJ

JADE SUPERMATCH



Silence



Integrated Wi-Fi control



Easy Installation



3D

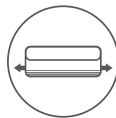

2-Way Piping Design



Self-Hygiene



Puri Clean



I Feel

- Self-Clean (Only Dual)
- Low noise level
- Integrated Wi-Fi control
- Easy installation
- 3D airflow: continuous movement of horizontal and vertical deflectors
- 2-way Piping design
- 56°C Steri-Clean
- Self-Hygiene
- Puri Clean
- I Feel

INDOOR UNIT	Model		AS25S2SJ1FA-3	AS35S2SJ1FA-3
Performance data				
Output power - COOLING	nom (min-max)	kW	2,60 (1,00-4,00)	3,50 (1,00-4,00)
Output power - HEATING	nom (min-max)	kW	3,20 (1,10-5,40)	4,20 (1,30-5,80)
Power supply		Ph/V/Hz	1/220-240/50	1/220-240/50
Interconnection cable			4 x 1,0	4 x 1,0
Treated air volume	H	m3/h	550	600
Indoor Unit				
High sound power - COOLING		dB	56	57
High sound power - HEATING		dB	56	57
Sound pressure - COOLING		dB(A)	36/32/29/15	37/33/30/16
Sound pressure - HEATING		dB(A)	36/32/29/15	37/33/30/16
Net dimensions	WxDxH	mm	923x215x320	923x215x320
Packaging dimensions	WxDxH	mm	1032x318x418	1032x318x418
Net/gross weight		kg	12,0/15,2	12,0/15,2
Installation data				
Liquid pipe	∅	mm	6,35 (1/4)	6,35 (1/4)
Gas pipe	∅	mm	9,52 (3/8)	9,52 (3/8)
Control				
Standard	Remote control		HQ-HJ	HQ-HJ

AS25 - AS35

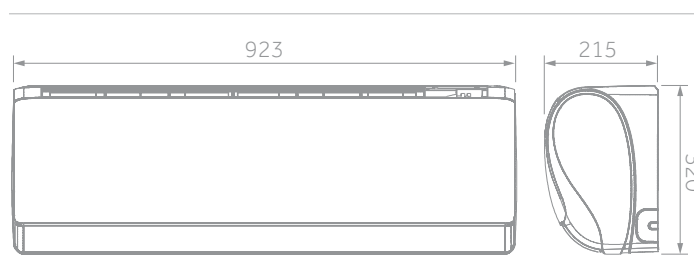

EXPERT NEW

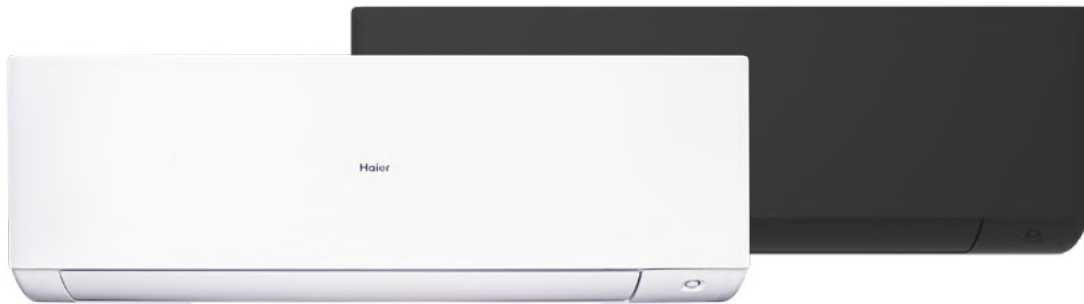

- 2,0 kW
- 2,5 kW
- 3,5 kW
- 5,0 kW
- 7,1 kW



Standard HQ-HJ



Easy Installation



I Feel

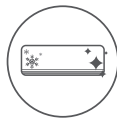

Self Clean



Coanda Plus



Eco Sensor

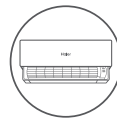

Easy to Disassemble

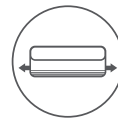

2-Way Piping Design



UVC Pro



Integrated Wi-Fi Control

- Easy Installation
- I Feel
- Self-Clean (Only Dual)
- Eco Sensor
- On-Off Card
- 2-Way Pipe Design
- UVC Pro
- Integrated Wi-Fi control

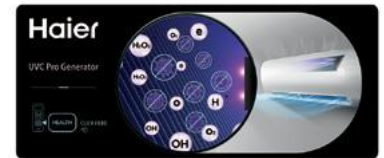

INDOOR UNIT	Model	AS20XCAHRA		AS25XCAHRA		AS35XCAHRA		AS50XCAHRA		AS71XCAHRA	
Performance data											
Output power - COOLING	nom (min-max)	kW	2,00	2,80 (0,80-3,20)	3,50 (1,00-4,00)	5,00 (1,40-5,50)	6,2(2,20-7,0)				
Output power - HEATING	nom (min-max)	kW	2,50	3,20 (0,80-4,20)	4,20 (1,00-5,20)	5,60 (1,70-6,20)	6,8(2,40-7,80)				
Power supply		Ph/V/Hz	1/220-240/50	1/220-240/50	1/220-240/50	1/220-240/50	1/220-240/50				
Interconnection cable			4 x 1,0	4 x 1,0	4 x 1,0	4 x 1,0	4 x 1,0				
Treated air volume	H	m3/h	730	730	800	880	920				
Indoor Unit											
High sound power - COOLING		dB	56	56	57	60	65				
High sound power - HEATING		dB	56	56	57	60	65				
Sound pressure - COOLING		dB(A)	39/32/25/16	39/32/25/16	40/33/26/17	45/37/29/20	47/45/37/29				
Sound pressure - HEATING		dB(A)	39/32/25/16	39/32/25/16	40/33/26/17	45/37/29/20	47/45/37/29				
Net dimensions	WxDxH	mm	895x313x236	895x313x236	895x313x236	895x313x236	895x236x313				
Packaging dimensions	WxDxH	mm	964x386x316	964x386x316	964x386x316	964x386x316	949x298x371				
Net/gross weight		kg	11,3/14,0	11,3/14,0	11,3/14,0	11,6/14,2	12,4/14,8				
Installation data											
Liquid pipe	∅	mm	6,35 (1/4)	6,35 (1/4)	6,35 (1/4)	6,35 (1/4)	9,52 (3/8)				
Gas pipe	∅	mm	9,52 (3/8)	9,52 (3/8)	9,52 (3/8)	12,70 (1/2)	15,88 (5/8)				
Control											
Standard	Remote control		HQ-HJ	HQ-HJ	HQ-HJ	HQ-HJ	HQ-HJ				

AS20 - AS25 - AS35 - AS50 - AS71

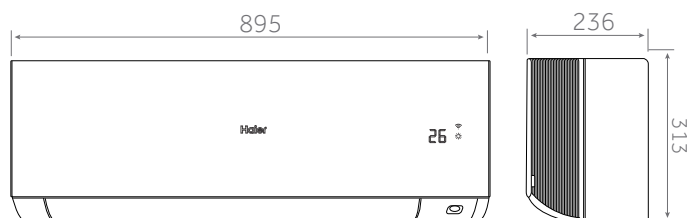

2,0 kW

2,5 kW

3,5 kW

4,2 kW

5,0 kW

7,1 kW



Standard HQ-HJ



Silence



Eco Sensor



Integrated Wi-Fi control



3D



Easy Installation



UVC Sterilisation



I Feel

- Low noise level
- Dual motion sensor
- Integrated Wi-Fi control
- 3D airflow: continuous movement of horizontal and vertical deflectors

- Easy installation
- UVC Sterilisation
- I Feel



INDOOR UNIT	Model	AS20S2SF1FA-MW3		AS25S2SF1FA-MW3		AS35S2SF1FA-MW3		AS50S2SF1FA-MW3		AS71S2SF1FA-MW3	
		AS20S2SF1FA-MB3		AS25S2SF1FA-MB3		AS35S2SF1FA-MB3		AS50S2SF1FA-MB3		AS71S2SF1FA-MB3	
Performance data											
Output power - COOLING	nom (min-max)	kW	2,00	2,60 (0,80-3,20)	3,50 (1,00-4,00)	5,20 (1,40-6,00)	7,00 (2,20-7,50)				
Output power - HEATING	nom (min-max)	kW	2,50	3,20 (0,80-4,20)	4,20 (1,00-5,20)	6,00 (1,40-6,90)	8,00 (2,40-8,50)				
Power supply		Ph/V/Hz	1/220-240/50		1/220-240/50		1/220-240/50		1/220-240/50		
Interconnection cable			4 x 1,0		4 x 1,0		4 x 1,0		4 x 1,0		
Treated air volume	H	m3/h	600	600	650	900	1100				
Indoor Unit											
High sound power - COOLING		dB	53	53	55	57	60				
High sound power - HEATING		dB	53	53	55	57	60				
Sound pressure - COOLING		dB(A)	38/32/25/16	38/32/25/16	39/33/26/17	45/41/37/28	47/43/37/33				
Sound pressure -HEATING		dB(A)	38/32/25/19	38/32/25/19	39/33/26/20	45/41/37/28	47/43/37/33				
Net dimensions	WxDxH	mm	856x197x300	856x197x300	856x197x300	999x225x323	1115x235x343				
Packaging dimensions	WxDxH	mm	952x283x389	952x283x389	952x283x389	1100x314x420	1202x319x432				
Net/gross weight		kg	9,5/12,0	9,5/12,0	9,5/12,0	12,0/15,0	15,2/18,2				
Installation data											
Liquid pipe	Ø	mm	6,35 (1/4)	6,35 (1/4)	6,35 (1/4)	6,35 (1/4)	9,52 (3/8)				
Gas pipe	Ø	mm	9,52 (3/8)	9,52 (3/8)	9,52 (3/8)	12,70 (1/2)	15,88 (5/8)				
Control											
Standard	Remote control		HQ-HJ	HQ-HJ	HQ-HJ	HQ-HJ	HQ-HJ				

AS20 - AS25 - AS35 - AS42

AS50

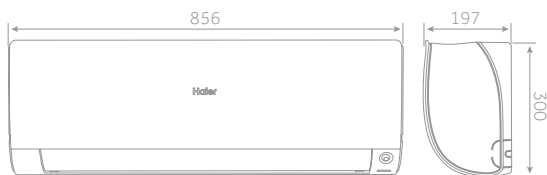

AS71

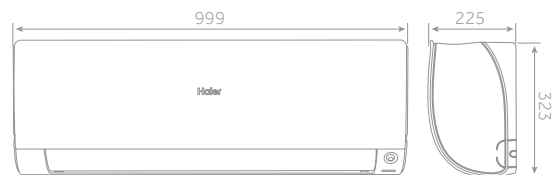

MOUNTING DIMENSIONS

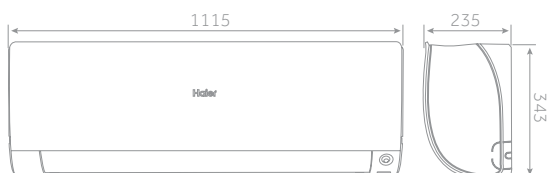

AS20-AS25-AS35-AS42-AS50

AS71

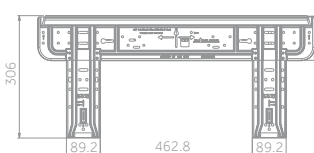
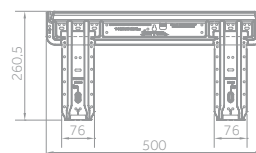

PEARL PREMIUM NEW



- 2,0 kW
- 2,5 kW
- 3,5 kW
- 5,0 kW
- 7,1 kW



Standard YR-HE + YR-HE2

- Silence
- Self Clean
- Integrated Wi-Fi control
- UVC Sterilisation
- Easy Installation
- Coanda Plus

- Low noise level
- UVC Sterilisation
- Self-Clean (Only Dual)
- Easy installation
- Integrated Wi-Fi control
- Coanda plus airflow



INDOOR UNIT	Model		AS20PBAHRA	AS25PBPBPHRA-PRE	AS35PBPBPHRA-PRE	AS50PDPHRA-PRE	AS71PEPHRA-PRE
Performance data							
Output power - COOLING	nom (min-max)	kW	2	2,7 (0,8-3,6)	3,6 (0,8-4,0)	5,0 (2,0-6,3)	7,1 (2,1 - 8,0)
Output power - HEATING	nom (min-max)	kW	2,5	3,1 (0,8-4,3)	3,9 (0,8-4,5)	5,8 (1,35-6,8)	7,4 (1,5-8,5)
Power supply		Ph/V/Hz	1/220-240/50	1/220-240/50	1/220-240/50	1/220-240/50	1/220-240/50
Interconnection cable			4 x 1,0	4 x 1,0	4 x 1,0	4 x 1,0	4 x 1,0
Treated air volume	H	m ³ /h	550	550	640	830	910
Indoor Unit							
High sound power - COOLING		dB	54	56	60	60	65
High sound power - HEATING		dB	54	56	60	60	65
Sound pressure - COOLING		dB(A)	37/32/28/18	37/32/28/18	38/33/29/18	44/40/35/28	48/42/35/27
Sound pressure - HEATING		dB(A)	37/32/28/18	37/32/28/18	38/33/29/18	44/40/35/28	48/42/35/27
Net dimensions	WxDxH	mm	805x200x290	805x200x292	805x200x292	975x220x320	1105x240x335
Packaging dimensions	WxDxH	mm	874x270x363	874x272x365	874x272x365	1090x316x413	1185x428x331
Net/gross weight		kg	8,3/10,5	8,1/10,3	8,6/10,8	11,6/14,4	15,4/18,9
Installation data							
Liquid pipe	∅	mm	6,35 (1/4)	6,35 (1/4)	6,35 (1/4)	6,35 (1/4)	6,35 (1/4)
Gas pipe	∅	mm	9,52 (3/8)	9,52 (3/8)	9,52 (3/8)	12,70 (1/2)	15,88 (5/8)
Control							
Standard	Remote control		YR-HE	YR-HE2	YR-HE2	YR-HE2	YR-HE2

AS20 - AS25 - AS35



AS50 - AS71



2,5 kW

3,5 kW

5,0 kW

6,8 kW



Standard YR-HE2

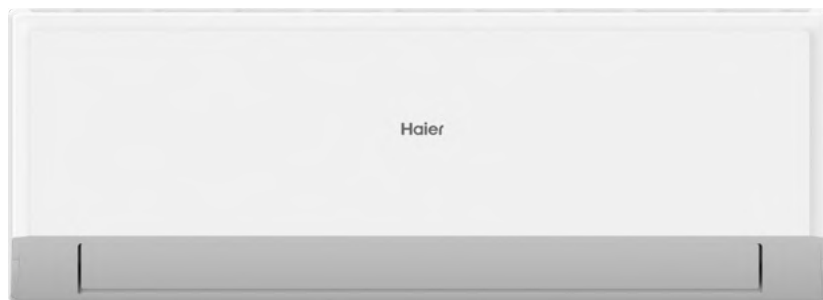

Coanda Plus

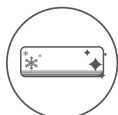

Self Clean



Integrated Wi-Fi Control



Easy Installation



56°C Steri-Clean



3-Level-Eco



Wi-Fi Easy Pair



I Feel

New features vs Revive

- Outdoor power supply
- Indoor works with multi
- Room card
- Increased efficiency
- Upgraded controller to HE2
- I Feel functionality for added comfort
- Wi-Fi quick pair
- 3-Level Eco

INDOOR UNIT	Model		AS25RBAHRA-3	AS35RBAHRA-4	AS50RCBHRA-4	AS68RDAHRA-4
Performance data						
Output power - COOLING	nom (min-max)	kW	2,7 (0,7-3,4)	3,2 (0,8-3,8)	4,8 (1,3-5,4)	6,2 (1,3-7,4)
Output power - HEATING	nom (min-max)	kW	2,9 (0,7-3,6)	3,9 (0,7-4,0)	4,8 (1,3-5,4)	6,3 (1,4-7,5)
Power supply		Ph/V/Hz	1/220-240/50	1/220-240/50	1/220-240/50	1/220-240/50
Interconnection cable			4 x 1,0	4 x 1,0	4 x 1,0	4 x 1,0
Treated air volume	H	m3/h	610/550	620	770/810	1100/1000
Indoor Unit						
High sound power - COOLING		dB	54	59	60	64
High sound power - HEATING		dB	54	59	60	64
Sound pressure - COOLING		dB(A)	37/32/28/18	38/33/29/18	44/40/35/28	47/45/37/29
Sound pressure -HEATING		dB(A)	37/32/28/18	38/33/29/18	44/40/35/28	47/45/37/29
Net dimensions	WxDxH	mm	805x199x292	805x199x292	875x212x304	975x222x318
Packaging dimensions	WxDxH	mm	876x365x272	876x272x365	945x390x296	1050x397x301
Net/gross weight		kg	8,8/10,5	8,8/10,9	10,0/12,0	11,6/14,4
Installation data						
Liquid pipe	∅	mm (inch)	6,35 (1/4)	6,35 (1/4)	6,35 (1/4)	6,35 (1/4)
Gas pipe	∅	mm (inch)	9,52 (3/8)	9,52 (3/8)	12,70 (1/2)	12,70 (1/2)
Control						
Standard	Remote control		YR-HE2			

AS25 - AS35



AS50

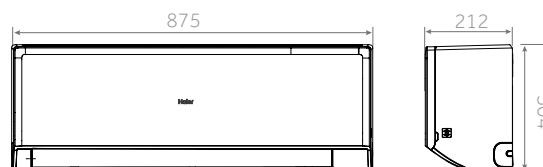

AS68

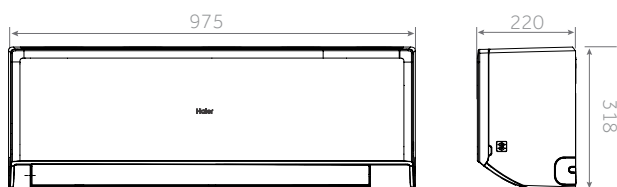

CONSOLE NEW

Haier

MULTISPLIT

2,5 kW

3,5 kW

4,2 kW

5,0 kW



Standard YR-HQS01



Silence



Double Flow



Sleep



Integrated Wi-Fi control



R32 Detector

- Low noise level
- Double airflow
- Compact design
- Sleep function for greater night time comfort
- Integrated Wi-Fi control
- R32 Detector

While Stocks Last

INDOOR UNIT	Model		AF25S2SD1FA(D)	AF35S2SD1FA(D)	AF42S2SD1FA(D)	AF50S2SD1FA(D)
Performance data						
Output power - COOLING	nom (min-max)	kW	2,50	3,40	4,20	5,0
Output power - HEATING	nom (min-max)	kW	3,00	3,50	4,70	5,4
Power supply		Ph/V/Hz	1/220-240/50/60	1/220-240/50/60	1/220-240/50/60	1/220-240/50/60
Treated air volume	(H/M/L/Q)	m3/h	450/400/350/300/250	500/450/400/350/300	580/530/480/430/380	600/550/500/450/400
Indoor Unit						
High sound power		dB	52	55	58	61
Sound pressure		dB(A)	40/32/25/20	42/34/26/21	46/37/33/28	50/42/37/32
Net dimensions	WxDxH	mm	700x210x600	700x210x600	700x210x600	700x210x600
Packaging dimensions	WxDxH	mm	783x303x695	783x303x695	783x303x695	783x303x695
Net/gross weight		kg	16,5/18,5	16,5/18,5	16,5/18,5	16,5/18,5
Installation data						
Liquid pipe	Ø	mm (inch)	6,35 (1/4)	6,35 (1/4)	6,35 (1/4)	6,35 (1/4)
Gas pipe	Ø	mm (inch)	9,52 (3/8)	9,52 (3/8)	9,52 (3/8)	12,70 (1/2)

AF25 - AF35 - AF42 - AF50

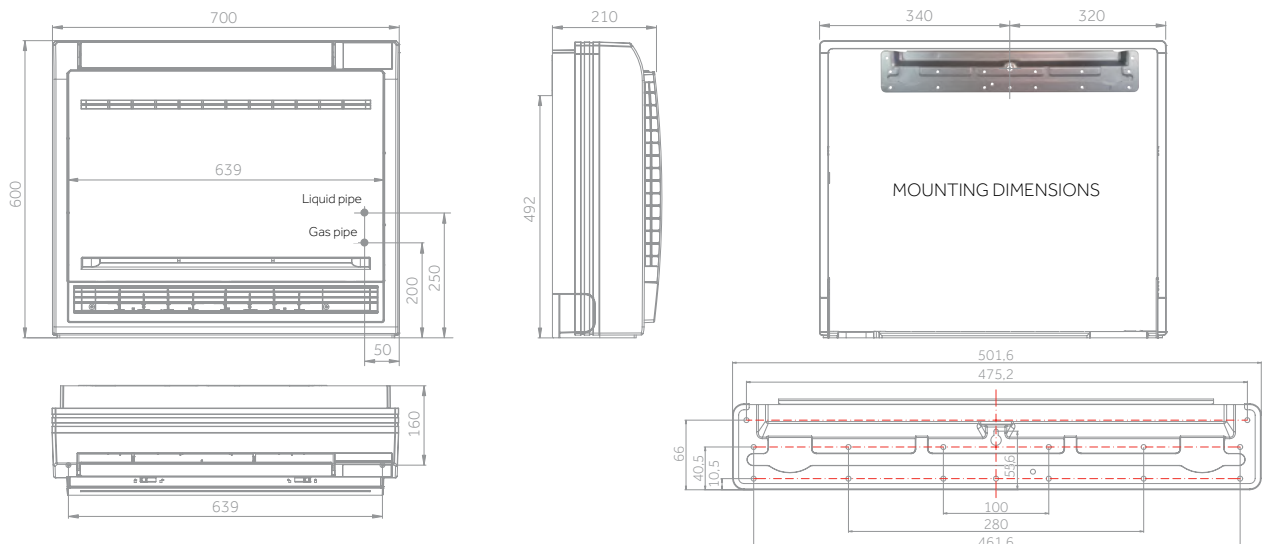

2,5 kW

3,5 kW

5,0 kW

7,1 kW

Please see pages 40 & 41
For Controller Options

NEW 1-WAY CASSETTE

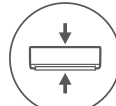

Compact Design



Integrated Wi-Fi control



Fresh Air



UVC Sterilisation

- Shallow Design (185 mm)
- Integrated Wi-Fi control
- 'Fresh air' knockout is incorporated in the chassis to allow fresh air introduction

INDOOR UNIT	Model		AB25S2SA1FA(H)	AB35S2SA1FA(H)	AB50S2SA1FA(H)	AB71S2SA1FA(H)
Performance data						
Output power - COOLING	nom (min-max)	kW	2,6	3,5	5	6,9
Output power - HEATING	nom (min-max)	kW	3,2	4,0	5,5	7,0
Power supply		Ph/V/Hz	1/220~240/50/60	1/220~240/50/60	1/220~240/50/60	1/220~240/50/60
Treated air volume	(H/M/L/Q)	m ³ /h	500/450/400/350	560/500/450/400	850/700/550/450	900/700/600/500
Indoor Unit						
High sound power		dB	62	64	65	67
Sound pressure		dB(A)	43/40/37/34	45/42/39/36	47/44/41/38	49/46/43/40
Net dimensions	WxDxH	mm	850x540x185	850x540x185	1170x540x185	1170x540x185
Packaging dimensions	WxDxH	mm	1043x648x270	1043x648x270	1363x648x270	1363x648x270
Net/gross weight		kg	20,8/24,9	20,8/24,9	26/31	27/32
Installation data						
Liquid pipe	Ø	mm (inch)	6,35 (1/4)	6,35 (1/4)	6,35 (1/4)	9,52 (3/8)
Gas pipe	Ø	mm (inch)	9,52 (3/8)	9,52 (3/8)	12,70 (1/2)	15,88 (5/8)
Panel	Model		P1B-1028IB	P1B-1028IB	P1B-1348IB	P1B-1348IB
Panel Net dimensions	WxDxH	mm	1028x600x45	1028x600x45	1348x600x45	1348x600x45
Panel Packaging dimensions	WxDxH	mm	1143x688x170	1143x688x170	1463x688x170	1463x688x170
Panel Net/gross weight		kg	3,9/8,0	3,9/8,0	5,1/9,8	5,1/9,8

AB25 - AB35 - AB50 - AB71

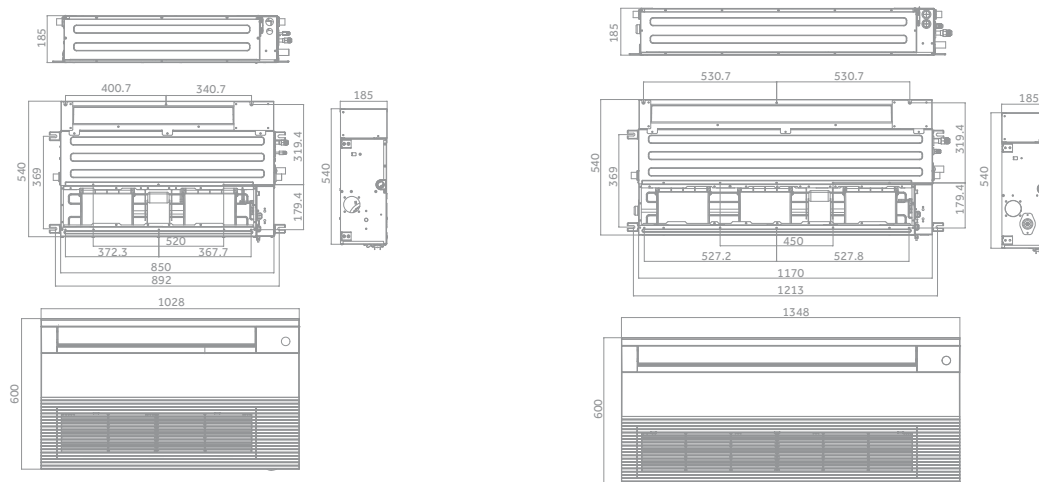

CASSETTE 620 NEW

Haier

2,5 kW

3,5 kW

5,0 kW

Please see pages 40 & 41
For Controller Options

MULTISPLIT



Silence



4Way Independent



Integrated Wi-Fi Control



UVC Sterilisation



On-Off Card



Fresh Air



- Low noise level
- Integrated Wi-Fi control
- UVC Sterilisation
- On-Off card
- 'Fresh air' knockout is incorporated in the chassis to allow fresh air introduction of up to 20% of nominal unit air flow without compromising the cooling capacity. More than 20% of the air conditioner's thermal cooling capacity is penalised

INDOOR UNIT	Model		AB25S2SC2FA(H)	AB35S2SC2FA(H)	AB50S2SC2FA(H)
Performance data					
Output power - COOLING	nom (min-max)	kW	2,50	3,50	5,00
Output power - HEATING	nom (min-max)	kW	3,20	4,00	5,50
Power supply		Ph/V/Hz	1/220-240/50/60	1/220-240/50/60	1/220-240/50/60
Treated air volume	(H/M/L/Q)	m3/h	580/480/380/280	620/520/450/350	700/620/500/400
Indoor Unit					
High sound power		dB	50	52	55
Sound pressure		dB(A)	35/32/28/26	36/33/30/27	42/37/35/32
Net dimensions	WxDxH	mm	570x570x260	570x570x260	570x570x260
Packaging dimensions	WxDxH	mm	718x680x380	718x680x380	718x680x380
Net/gross weight		kg	18,5/22,0	18,5/22,0	19,0/22,0
Installation data					
Liquid pipe	Ø	mm (inch)	6,35 (1/4)	6,35 (1/4)	6,35 (1/4)
Gas pipe	Ø	mm (inch)	9,52 (3/8)	9,52 (3/8)	12,70 (1/2)
Panel	Model		PB-620KB(H)	PB-620KB(H)	PB-620KB(H)
Panel Net dimensions	WxDxH	mm	620x620x60	620x620x60	620x620x60
Panel Packaging dimensions	WxDxH	mm	660x660x115	660x660x115	660x660x115
Panel Net/gross weight		kg	2,8/4,5	2,8/4,5	2,8/4,5

AB25 - AB35 - AB50

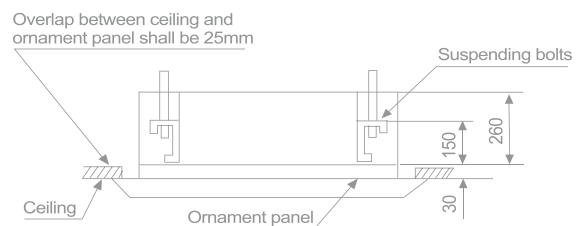
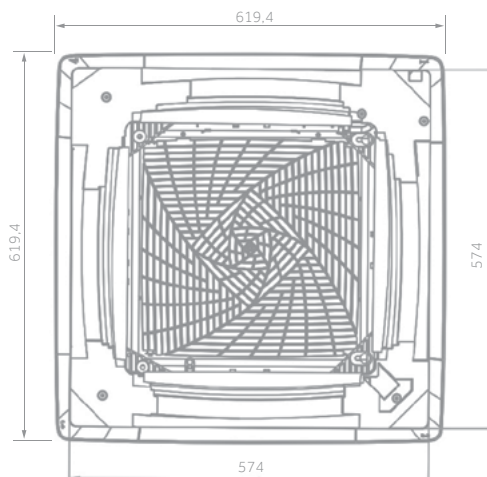

NEW ROUND FLOW CASSETTE

7,1 kW

Please see pages 40 & 41
For Controller Options



Silence



8Way
Independent



Integrated
Wi-Fi Control



UVC
Sterilisation



Fresh Air

- Low noise level
- 8 ways airflow
- Integrated Wi-Fi control
- UVC Sterilisation
- 'Fresh air' knockout is incorporated in the chassis to allow fresh air introduction of up to 20% of nominal unit air flow without compromising the cooling capacity. More than 20% of the air conditioner's thermal cooling capacity is penalised.

INDOOR UNIT	Model	AB71S2SG1FA(H)	
Performance data			
Output power - COOLING	nom (min-max)	kW	7,10
Output power - HEATING	nom (min-max)	kW	8,00
Power supply		Ph/V/Hz	1/220-240/50/60
Treated air volume	(H/M/L/Q)	m3/h	1260/1070/820/680
Indoor Unit			
High sound power		dB	55
Sound pressure		dB(A)	42/40/38/35
Net dimensions	WxDxH	mm	840x840x204
Packaging dimensions	WxDxH	mm	990x990x310
Net/gross weight		kg	27,0/32,0
Installation data			
Liquid pipe	Ø	mm (inch)	9,52 (3/8)
Gas pipe	Ø	mm (inch)	15,88 (5/8)
Panel	Model		PB-950KB(H)
Panel Net dimensions	WxDxH	mm	950x950x50
Panel Packaging dimensions	WxDxH	mm	1013x1025x123
Panel Net/gross weight		kg	6,5/9,5

AB71

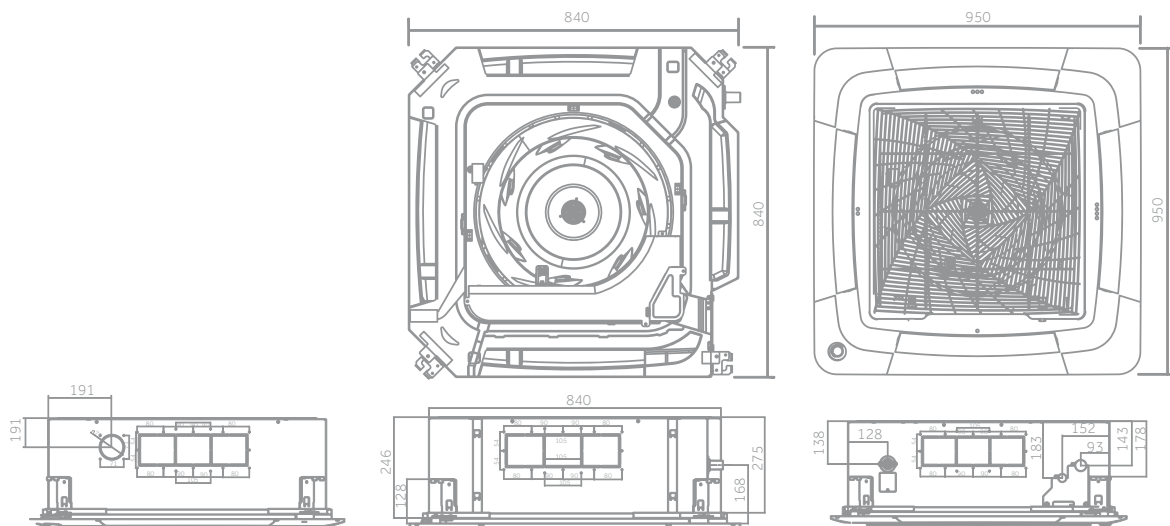

CEILING FLOOR NEW

Haier

MULTISPLIT

2,5 kW

3,5 kW

5,0 kW

7,1 kW

Please see pages 40 & 41
For Controller Options



Silence



Flow +



5 Speed Fan



Fresh Air

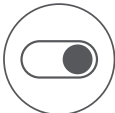

On-Off Card



Integrated
Wi-Fi Control



UVC
Sterilisation

- Low noise level
- Flow +: Internal deflectors are divided into two groups with independent motors (independent right-left airflow)
- 5 fan speed: turbo, high, medium, low, super low (only with YR-HQS01 or wired controller)
- 'Fresh air' knockout is incorporated in the chassis to allow fresh air introduction of up to 20% of nominal unit air flow without compromising the cooling capacity. More than 20% of the air conditioner's thermal cooling capacity is penalised
- Integrated Wi-Fi control
- UVC Sterilisation

INDOOR UNIT	Model		AC25S2SG1FA(H)	AC35S2SG1FA(H)	AC50S2SG1FA(H)	AC71S2SG1FA(H)
Performance data						
Output power - COOLING	nom (min-max)	kW	2,50	3,50	5,00	7,10
Output power - HEATING	nom (min-max)	kW	3,10	4,00	5,80	7,50
Power supply		Ph/V/Hz	1/220~240/50/60	1/220~240/50/60	1/220~240/50/60	1/220~240/50/60
Treated air volume	(H/M/L/Q)	m3/h	580/480/380/280	750/620/500/400	880/750/650/500	1250/1128/930/840
Indoor Unit						
High sound power		dB	50	53	57	61
Sound pressure		dB(A)	35/32/28/26	39/36/33/30	44/41/38/35	43/40/38/35
Net dimensions	WxDxH	mm	1000x230x680	1000x230x680	1000x230x680	1325x230x680
Packaging dimensions	WxDxH	mm	1100x305x779	1100x305x779	1100x305x779	1425x305x779
Net/gross weight		kg	26,0/32,0	26,0/32,0	26,0/32,0	33,5/41,9
Installation data						
Liquid pipe	Ø	mm (inch)	6,35 (1/4)	6,35 (1/4)	6,35 (1/4)	9,52 (3/8)
Gas pipe	Ø	mm (inch)	9,52 (3/8)	9,52 (3/8)	12,70 (1/2)	15,88 (5/8)

AC25 - AC35 - AC50 - AC71

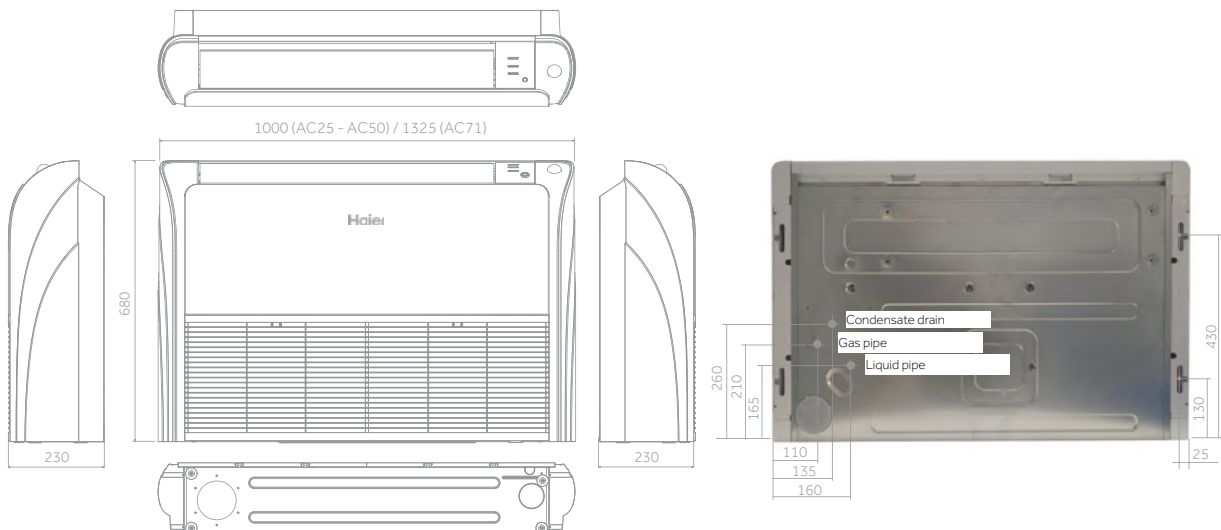

The data in this catalogue is purely indicative as the data may vary. Please be advised to check the accuracy of the data with the supplier before purchasing products.

SLIM DUCT LOW PRESSURE

2,5 kW

3,5 kW

5,0 kW

7,1 kW

Please see pages 40 & 41
For Controller Options



Silence

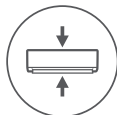

Compact Design



3D



Condensate Drain Pump



Flexible Installation



UVC Sterilisation



Integrated Wi-Fi Control



- Low noise level
- Compact design
- Panel kit (OPTIONAL): air supply and intake grill

- Condensate drain pump
- Flexible installation
- UVC Sterilisation
- Integrated Wi-Fi control

INDOOR UNIT	Model		AD25S2SS1FA(H)	AD35S2SS1FA(H)	AD50S2SS1FA(H)	AD71S2SS1FA(H)
Performance data						
Output power - COOLING	nom (min-max)	kW	2,50	3,50	5,00	7,10
Output power - HEATING	nom (min-max)	kW	3,20	4,00	5,50	7,50
Power supply		Ph/V/Hz	1/220-240/50/60	1/220-240/50/60	1/220-240/50/60	1/220-240/50/60
Treated air volume	(H/M/L/Q)	m ³ /h	580/480/380/280	600/480/420/350	900/750/600	1000/850/750
External static pressure		Pa	0/10/20/40	0/10/20/40	0/10/20/40	0/10/20/40
Indoor Unit						
High sound power		dB	50	53	54	57
Sound pressure		dB(A)	29/28/25	33/28/25	36/34/32	49/46/44/42
Net dimensions	WxDxH	mm	850x420x185	850x420x185	1170x420x185	1170x420x185
Packaging dimensions	WxDxH	mm	1045x530x260	1045x530x260	1365x530x260	1365x530x260
Net/gross weight		kg	16,0/21,0	16,0/21,0	22,0/28,0	25,2/28,4
Installation data						
Liquid pipe	Ø	mm (inch)	6,35 (1/4)	6,35 (1/4)	6,35 (1/4)	9,52 (3/8)
Gas pipe	Ø	mm (inch)	9,52 (3/8)	9,52 (3/8)	12,70 (1/2)	15,88 (5/8)
Panel	Model		P1B-890IA/D	P1B-890IA/D	P1B-1210IA/D	P1B-1210IA/D
Panel Net dimensions	WxDxH	mm	890x190x100 (outlet panel) 890x290,5x32,4 (inlet panel)		1210x190x100 (outlet panel) 1210x290,5x32,4 (inlet panel)	
Panel Packaging dimensions	WxDxH	mm	938x335x220	938x335x220	1258x335x220	1258x335x220
Panel Net/gross weight			4,0/5,0	4,0/5,0	5,0/6,0	5,0/6,0

AD25 - AD35 - AD50 - AD71

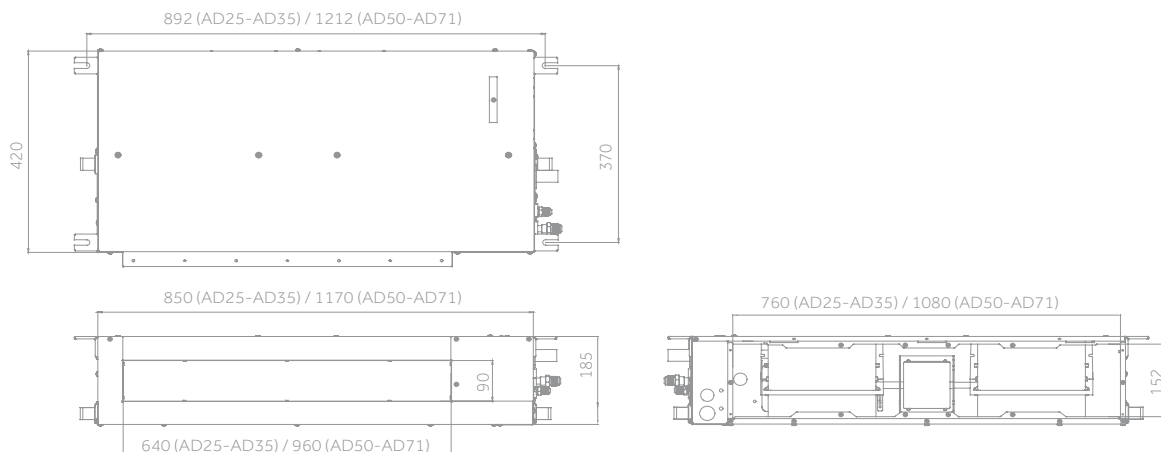

DUCTED MEDIUM PRESSURE

3,5 kW

5,0 kW

7,1 kW

Please see pages 40 & 41 For Controller Options



Silence

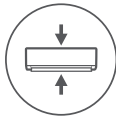

Compact Design



Fresh Air



Condensate Drain Pump



Easy Installation



UVC Sterilisation



Integrated Wi-Fi Control

- Low noise level
- Compact design
- Fresh Air allows changing the ambient air
- Condensate drain pump
- Easy installation
- Integrated Wi-Fi control
- UVC Sterilisation



INDOOR UNIT	Model		AD35S2SM3FA(H)	AD50S2SM3FA(H)	AD71S2SM3FA(H)
Performance data					
Output power - COOLING	nom (min-max)	kW	3,50	5,00	7,10
Output power - HEATING	nom (min-max)	kW	4,00	6,00	7,50
Power supply		Ph/V/Hz	1/220-240/50/60	1/220-240/50/60	1/220-240/50/60
Treated air volume	(H/M/L/Q)	m3/h	840/720/600/450	1020/900/780/550	1440/1260/1100/900
External static pressure		Pa	25(default)/37/50/70/90/100/110/120/130/150	25(default)/37/50/70/90/100/110/120/130/150	25(default)/37/50/70/90/100/110/120/130/150
Indoor Unit					
High sound power		dB	55	56	58
Sound pressure		dB(A)	41/35/28/26	43/37/30/28	44/41/39/36
Net dimensions	WxDxH	mm	700x700x248	1100x700x248	1100x700x248
Packaging dimensions	WxDxH	mm	914x866x318	1316x866x318	1316x866x318
Net/gross weight		kg	26,0/30,0	31,0/35,0	31,0/35,0
Installation data					
Liquid pipe	Ø	mm (inch)	6,35 (1/4)	6,35 (1/4)	9,52 (3/8)
Gas pipe	Ø	mm (inch)	9,52 (3/8)	12,70 (1/2)	15,88 (5/8)

AD35 - AD50 - AD71

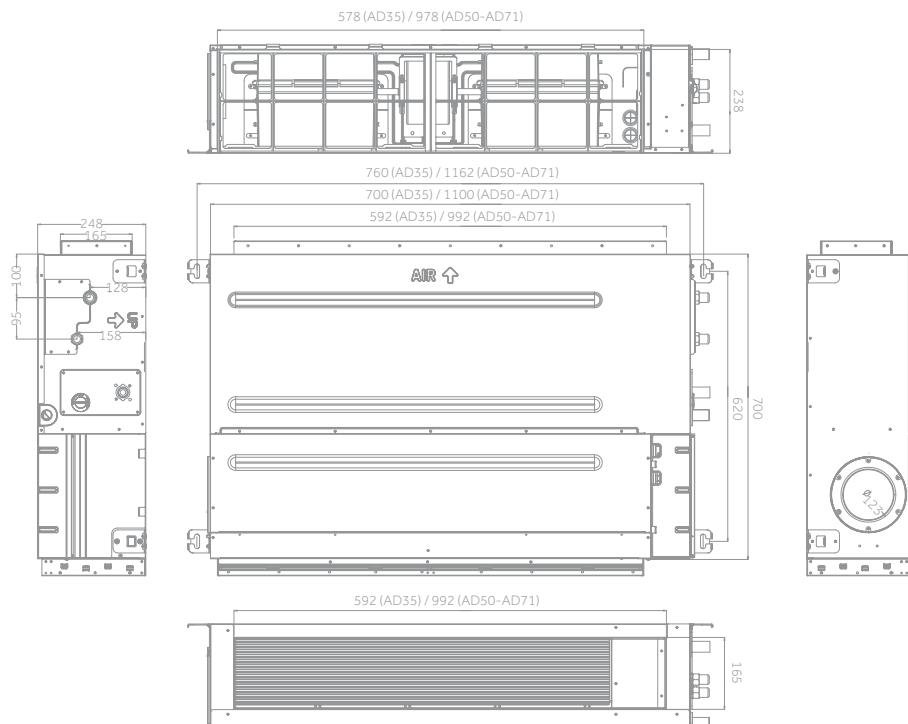

MultiSplit OUTDOOR UNITS

2U40S2SM1FA (2 couplings)

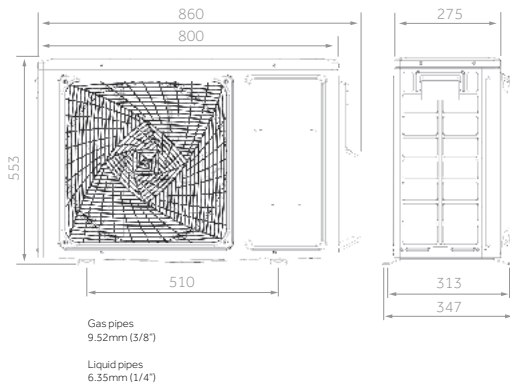

2U50S2SM1FA-3 (2 couplings)

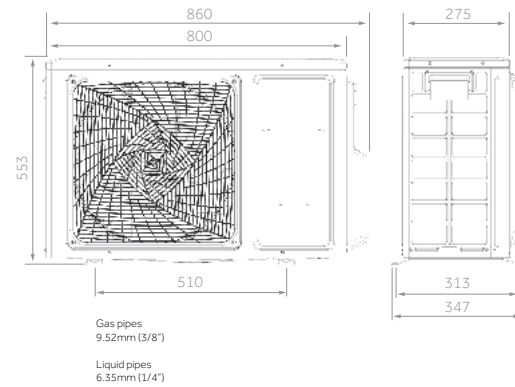

3U55S2SR5FA - 3U70S2SR5FA (3 couplings)

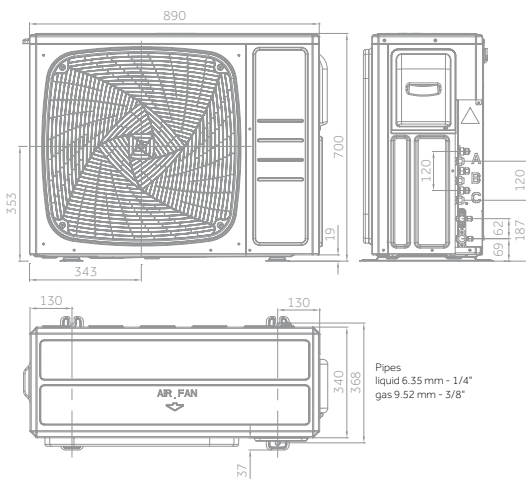

4U75S2SR5FA - 4U85S2SR5FA (4 couplings)

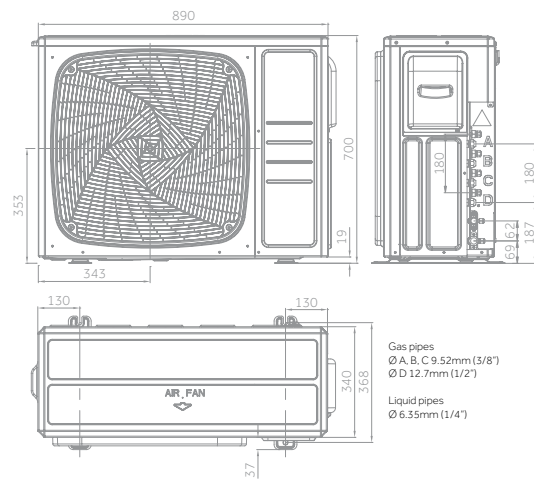

MultiSplit OUTDOOR UNITS

5U90S2SS5FA - 5U105S2SS5FA (5 couplings)

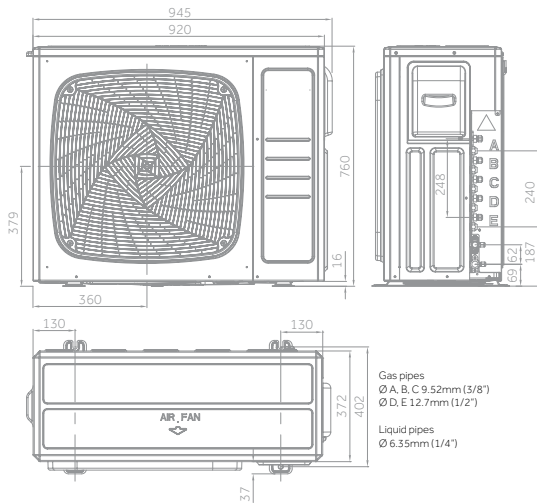

5U125S2SN1FA (5 couplings)

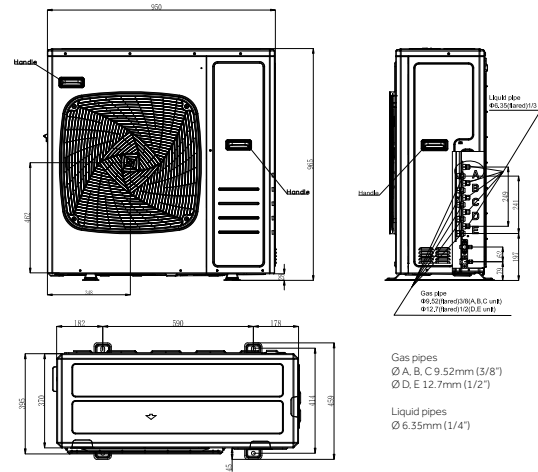

3U55S2WR1FA (3 couplings) +
4U70S2WR1FA (4 couplings)

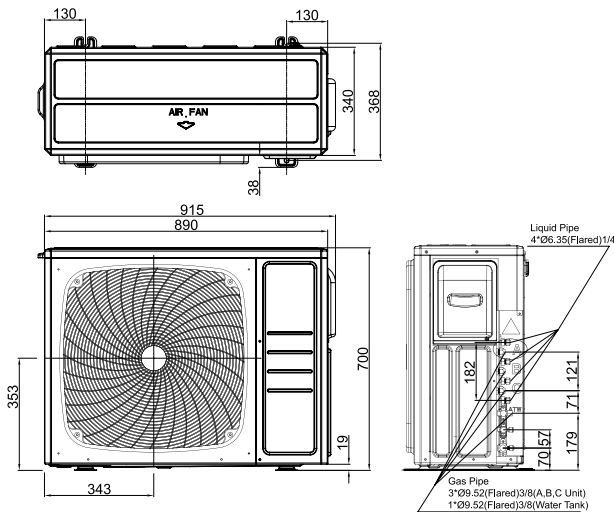

MULTISPLIT COMPATIBILITY

N. IU	IU A	IU B	IU C	IU D	IU E	Total IU kW	MultiSplit Outdoor Units									Total Combinations
							2U40S2SM1FA	2U50S2SM1FA-3	3U55S2SR5FA	3U70S2SR5FA	4U75S2SR5FA	4U85S2SR5FA	5U90S2SS5FA	5U105S2SS5FA	5U125S2SN1FA	
2	20	20	0	0	0	4,0	✓	✓	✓	✓	✓		✓			8
	20	25	0	0	0	4,5	✓	✓	✓	✓	✓	✓	✓	✓	✓	10
	20	35	0	0	0	5,5	✓	✓	✓	✓	✓	✓	✓	✓	✓	10
	20	42	0	0	0	6,2		✓	✓	✓	✓	✓	✓	✓	✓	8
	20	50	0	0	0	7,0			✓	✓	✓	✓	✓	✓	✓	8
	20	71	0	0	0	9,1				✓	✓	✓	✓	✓	✓	5
	25	25	0	0	0	5,0	✓	✓	✓	✓	✓	✓	✓	✓	✓	10
	25	35	0	0	0	6,0	✓	✓	✓	✓	✓	✓	✓	✓	✓	10
	25	42	0	0	0	6,7		✓	✓	✓	✓	✓	✓	✓	✓	8
	25	50	0	0	0	7,5			✓	✓	✓	✓	✓	✓	✓	8
	25	71	0	0	0	9,6				✓	✓	✓	✓	✓	✓	5
	35	35	0	0	0	7,0		✓	✓	✓	✓	✓	✓	✓	✓	9
	35	42	0	0	0	7,7		✓		✓	✓	✓	✓	✓	✓	7
	35	50	0	0	0	8,5				✓	✓	✓	✓	✓	✓	7
	35	71	0	0	0	10,6					✓	✓	✓	✓	✓	5
	42	42	0	0	0	8,4		✓		✓	✓	✓	✓	✓	✓	7
	42	50	0	0	0	9,2				✓	✓	✓	✓	✓	✓	5
	42	71	0	0	0	11,3					✓	✓	✓	✓	✓	5
	50	50	0	0	0	10,0					✓	✓	✓	✓	✓	5
	50	71	0	0	0	12,1					✓	✓	✓	✓	✓	5
	71	71	0	0	0	14,2						✓	✓	✓	✓	3
3	20	20	20	0	0	6,0			✓	✓	✓	✓	✓	✓	✓	7
	20	20	25	0	0	6,5			✓	✓	✓	✓	✓	✓	✓	7
	20	20	35	0	0	7,5			✓	✓	✓	✓	✓	✓	✓	7
	20	20	42	0	0	8,2				✓	✓	✓	✓	✓	✓	6
	20	20	50	0	0	9,0				✓	✓	✓	✓	✓	✓	6
	20	20	71	0	0	11,1					✓	✓	✓	✓	✓	5
	20	25	25	0	0	7,0			✓	✓	✓	✓	✓	✓	✓	7
	20	25	35	0	0	8,0			✓	✓	✓	✓	✓	✓	✓	7
	20	25	42	0	0	8,7				✓	✓	✓	✓	✓	✓	6
	20	25	50	0	0	9,5				✓	✓	✓	✓	✓	✓	6
	20	25	71	0	0	11,6					✓	✓	✓	✓	✓	5
	20	35	35	0	0	9,0				✓	✓	✓	✓	✓	✓	6
	20	35	42	0	0	9,7				✓	✓	✓	✓	✓	✓	6
	20	35	50	0	0	10,5					✓	✓	✓	✓	✓	5
	20	35	71	0	0	12,6					✓	✓	✓	✓	✓	5
	20	42	42	0	0	10,4					✓	✓	✓	✓	✓	5
	20	42	50	0	0	11,2					✓	✓	✓	✓	✓	5
	20	42	71	0	0	13,3					✓	✓	✓	✓	✓	5
	20	50	50	0	0	12,0						✓	✓	✓	✓	3
	20	50	71	0	0	14,1						✓	✓	✓	✓	2
	25	25	25	0	0	7,5			✓	✓	✓	✓	✓	✓	✓	7
	25	25	35	0	0	8,5			✓	✓	✓	✓	✓	✓	✓	7
	25	25	42	0	0	9,2				✓	✓	✓	✓	✓	✓	6
	25	25	50	0	0	10,0					✓	✓	✓	✓	✓	5
	25	25	71	0	0	12,1						✓	✓	✓	✓	5
	25	35	35	0	0	9,5				✓	✓	✓	✓	✓	✓	6
	25	35	42	0	0	10,2					✓	✓	✓	✓	✓	5
	25	35	50	0	0	11,0						✓	✓	✓	✓	5
	25	35	71	0	0	13,1						✓	✓	✓	✓	5
	25	42	42	0	0	10,9						✓	✓	✓	✓	5
	25	42	50	0	0	11,7						✓	✓	✓	✓	5
	25	42	71	0	0	13,8						✓	✓	✓	✓	3
	25	50	50	0	0	12,5							✓	✓	✓	4
	25	50	71	0	0	14,6							✓	✓	✓	2
	35	35	35	0	0	10,5					✓	✓	✓	✓	✓	5
	35	35	42	0	0	11,2						✓	✓	✓	✓	5
	35	35	50	0	0	12,0						✓	✓	✓	✓	5
	35	35	71	0	0	14,1							✓	✓	✓	3
	35	42	42	0	0	11,9							✓	✓	✓	4
	35	42	50	0	0	12,7							✓	✓	✓	4
	35	50	50	0	0	13,5							✓	✓	✓	4
42	42	42	0	0	12,6							✓	✓	✓	4	
42	42	50	0	0	13,4							✓	✓	✓	4	
42	50	50	0	0	14,2							✓	✓	✓	2	
50	50	50	0	0	15,0							✓	✓	✓	2	
4	20	20	20	20	0	8,0				✓	✓	✓	✓	✓	✓	5
	20	20	20	25	0	8,5				✓	✓	✓	✓	✓	✓	5
	20	20	20	35	0	9,5				✓	✓	✓	✓	✓	✓	5
	20	20	20	42	0	10,2				✓	✓	✓	✓	✓	✓	5
	20	20	20	50	0	11,0				✓	✓	✓	✓	✓	✓	5
	20	20	20	71	0	13,1				✓	✓	✓	✓	✓	✓	5
	20	20	25	25	0	9,0				✓	✓	✓	✓	✓	✓	5
	20	20	25	35	0	10,0				✓	✓	✓	✓	✓	✓	5
	20	20	25	42	0	10,7				✓	✓	✓	✓	✓	✓	5
	20	20	25	50	0	11,5				✓	✓	✓	✓	✓	✓	5
	20	20	25	71	0	13,6				✓	✓	✓	✓	✓	✓	5
	20	20	35	35	0	11,0				✓	✓	✓	✓	✓	✓	5
	20	20	35	42	0	11,7				✓	✓	✓	✓	✓	✓	5
	20	20	35	50	0	12,5				✓	✓	✓	✓	✓	✓	5
	20	20	35	71	0	14,6				✓	✓	✓	✓	✓	✓	2
	20	20	42	42	0	12,4				✓	✓	✓	✓	✓	✓	5
	20	20	42	50	0	13,2				✓	✓	✓	✓	✓	✓	5
	20	20	50	50	0	14,0					✓	✓	✓	✓	✓	3
	20	25	25	25	0	9,5				✓	✓	✓	✓	✓	✓	5
	20	25	25	35	0	10,5				✓	✓	✓	✓	✓	✓	5
	20	25	25	42	0	11,2				✓	✓	✓	✓	✓	✓	5
	20	25	25	50	0	12,0				✓	✓	✓	✓	✓	✓	5
	20	25	25	71	0	14,1					✓	✓	✓	✓	✓	2
	20	25	35	35	0	11,5				✓	✓	✓	✓	✓	✓	5
	20	25	35	42	0	12,2				✓	✓	✓	✓	✓	✓	5
	20	25	35	50	0	13,0				✓	✓	✓	✓	✓	✓	5

CONT'D →

LEGEND

✓ COMBINATION ALLOWED

OPERATING SIMULTANEOUSLY

OK

NOTE - THE POWER OF THE INDOOR UNITS IS HIGHER THAN THE POWER OF THE OUTDOOR UNITS

MULTISPLIT COMPATIBILITY

N. IU	IU A	IU B	IU C	IU D	IU E	Total IU kW	MultiSplit Outdoor Units					Total Combinations					
							2U40S2SM1FA	2U50S2SM1FA-3	3U55S2SR5FA	3U70S2SR5FA	4U75S2SR5FA		4U85S2SR5FA	5U90S2SS5FA	5U105S2SS5FA	5U125S2SN1FA	
4	20	25	42	42	0	12,9					✓	✓	✓	✓	✓	5	
	20	25	42	50	0	13,7					✓	✓	✓	✓	✓	5	
	20	25	50	50	0	14,5							✓	✓	✓	2	
	20	35	35	35	0	12,5					✓	✓	✓	✓	✓	5	
	20	35	35	42	0	13,2					✓	✓	✓	✓	✓	5	
	20	35	35	50	0	14,0							✓	✓	✓	3	
	20	35	42	42	0	13,9							✓	✓	✓	3	
	20	35	42	50	0	14,7							✓	✓	✓	2	
	20	42	42	42	0	14,6							✓	✓	✓	3	
	25	25	25	25	0	10,0					✓	✓	✓	✓	✓	5	
	25	25	25	35	0	11,0					✓	✓	✓	✓	✓	5	
	25	25	25	42	0	11,7					✓	✓	✓	✓	✓	5	
	25	25	25	50	0	12,5							✓	✓	✓	4	
	25	25	25	71	0	14,6							✓	✓	✓	2	
	25	25	35	35	0	12,0					✓	✓	✓	✓	✓	5	
	25	25	35	42	0	12,7							✓	✓	✓	4	
	25	25	35	50	0	13,5							✓	✓	✓	4	
	25	25	42	42	0	13,4							✓	✓	✓	4	
	25	25	42	50	0	14,2							✓	✓	✓	2	
	25	25	50	50	0	15,0							✓	✓	✓	2	
	25	35	35	35	0	13,0							✓	✓	✓	4	
	25	35	35	42	0	13,7							✓	✓	✓	4	
	25	35	35	50	0	14,5							✓	✓	✓	2	
	25	35	42	42	0	14,4							✓	✓	✓	2	
	35	35	35	35	0	14,0							✓	✓	✓	4	
	35	35	35	42	0	14,7							✓	✓	✓	2	
	5	20	20	20	20	20	10,0						✓	✓	✓	✓	3
		20	20	20	20	25	10,5						✓	✓	✓	✓	3
		20	20	20	20	35	11,5						✓	✓	✓	✓	3
		20	20	20	20	42	12,2						✓	✓	✓	✓	3
		20	20	20	20	50	13,0						✓	✓	✓	✓	3
		20	20	20	20	71	15,1							✓	✓	✓	1
		20	20	20	25	25	11,0						✓	✓	✓	✓	3
		20	20	20	25	35	12,0						✓	✓	✓	✓	3
		20	20	20	25	42	12,7						✓	✓	✓	✓	3
20		20	20	25	50	13,5						✓	✓	✓	✓	3	
20		20	20	25	71	15,6							✓	✓	✓	1	
20		20	20	35	35	13,0						✓	✓	✓	✓	3	
20		20	20	35	42	13,7						✓	✓	✓	✓	3	
20		20	20	35	50	14,5							✓	✓	✓	2	
20		20	20	35	71	16,6							✓	✓	✓	1	
20		20	20	42	42	14,4							✓	✓	✓	2	
20		20	20	42	50	15,2							✓	✓	✓	1	
20		20	20	42	71	17,3							✓	✓	✓	1	
20		20	25	25	25	11,5						✓	✓	✓	✓	3	
20		20	25	25	35	12,5						✓	✓	✓	✓	3	
20		20	25	25	42	13,2						✓	✓	✓	✓	3	
20		20	25	25	50	14,0						✓	✓	✓	✓	3	
20		20	25	25	71	16,1							✓	✓	✓	1	
20		20	25	35	35	13,5						✓	✓	✓	✓	3	
20		20	25	35	42	14,2						✓	✓	✓	✓	2	
20		20	25	35	50	15,0							✓	✓	✓	2	
20		20	25	35	71	17,1							✓	✓	✓	1	
20		20	25	42	42	14,9							✓	✓	✓	2	
20		20	25	42	50	15,7							✓	✓	✓	1	
20		20	25	42	71	17,8							✓	✓	✓	1	
20		20	35	35	35	14,5							✓	✓	✓	2	
20		20	35	35	42	15,2							✓	✓	✓	1	
20		20	35	35	50	16,0							✓	✓	✓	1	
20		20	35	35	71	18,1							✓	✓	✓	1	
20		25	25	25	25	12,0						✓	✓	✓	✓	3	
20		25	25	25	35	13,0						✓	✓	✓	✓	3	
20		25	25	25	42	13,7						✓	✓	✓	✓	3	
20		25	25	25	50	14,5							✓	✓	✓	2	
20		25	25	25	71	16,6							✓	✓	✓	1	
20		25	25	35	35	14,0							✓	✓	✓	2	
20		25	25	35	42	14,7							✓	✓	✓	2	
20		25	25	35	50	15,5							✓	✓	✓	1	
20		25	25	35	71	17,6							✓	✓	✓	1	
20		25	35	35	35	15,0							✓	✓	✓	2	
20		25	35	35	42	15,7							✓	✓	✓	1	
20		25	35	35	50	16,5							✓	✓	✓	1	
20		25	35	35	71	18,6							✓	✓	✓	1	
25		25	25	25	25	12,5						✓	✓	✓	✓	3	
25		25	25	25	35	13,5						✓	✓	✓	✓	3	
25		25	25	25	42	14,2							✓	✓	✓	2	
25		25	25	25	50	15,0							✓	✓	✓	2	
25		25	25	25	71	17,1							✓	✓	✓	2	
25		25	25	35	35	14,5							✓	✓	✓	2	
25		25	25	35	42	15,2							✓	✓	✓	1	
25		25	25	35	50	16,0							✓	✓	✓	1	
25		25	25	35	71	18,1							✓	✓	✓	1	
25		25	25	42	42	15,2							✓	✓	✓	1	
25		25	25	42	50	16,0							✓	✓	✓	1	
25		25	25	42	71	18,2							✓	✓	✓	1	
25		25	25	50	50	20,0							✓	✓	✓	1	
25	25	35	35	35	18,0							✓	✓	✓	1		
25	25	35	35	42	18,7							✓	✓	✓	1		
25	25	35	35	50	19,5							✓	✓	✓	1		
25	25	42	42	42	20,1							✓	✓	✓	1		
25	25	42	42	50	20,9							✓	✓	✓	1		
25	35	35	35	35	19,0							✓	✓	✓	1		
25	35	35	35	42	19,7							✓	✓	✓	1		
25	35	35	35	50	20,5							✓	✓	✓	1		
35	35	35	35	35	21,0							✓	✓	✓	1		
35	35	35	35	42	21,7							✓	✓	✓	1		

LEGEND	
✓	COMBINATION ALLOWED
OPERATING SIMULTANEOUSLY	
OK	
NOTE - THE POWER OF THE INDOOR UNITS IS HIGHER THAN THE POWER OF THE OUTDOOR UNITS	

The data in this catalogue is purely indicative as the data may vary. Please be advised to check the accuracy of the data with the supplier before purchasing products.

3S COMBINATIONS TABLE



3U55S2WR1FA (Values in the table refer to EXPERT series)

COOLING																		
Combinations			Output power (kW)			System output power (kW)			Absorbed power (kW)			Absorbed current (A)			EER	SEER	Energy class	
IU	A	B	C	A	B	C	Min	Nom	Max	Min	Nom	Max	Min	Nom	Max			
1	2.0	—	—	2.00	—	—	0.80	2.00	2.80	0.55	0.62	1.30	2.44	2.75	5.75	—	—	—
	2.5	—	—	2.60	—	—	0.80	2.60	3.90	0.55	0.79	1.34	2.44	3.50	5.91	—	—	—
	3.5	—	—	3.60	—	—	1.00	3.60	5.30	0.55	1.09	1.65	2.44	4.84	7.30	—	—	—
	4.2	—	—	4.40	—	—	1.30	4.40	5.00	0.55	1.32	1.90	2.44	5.86	8.40	—	—	—
	5.0	—	—	5.20	—	—	1.40	5.20	7.00	0.55	1.55	2.00	2.44	6.88	8.85	—	—	—
	7.1	—	—	6.50	—	—	1.50	6.50	7.40	0.55	1.92	2.60	2.44	8.52	11.50	—	—	—
2	2.0	2.0	—	2.00	2.00	—	1.80	4.00	5.60	0.55	1.21	2.60	2.44	5.37	11.50	3.31	6.80	A++
	2.0	2.5	—	2.00	2.60	—	1.80	4.60	6.70	0.55	1.35	2.60	2.44	5.99	11.50	3.41	6.80	A++
	2.0	3.5	—	2.00	3.60	—	1.80	5.60	7.50	0.55	1.65	2.60	2.44	7.32	11.50	3.39	6.90	A++
	2.0	4.2	—	2.00	4.40	—	1.80	6.40	7.60	0.55	1.89	2.60	2.44	8.39	11.50	3.39	6.90	A++
	2.0	5.0	—	1.50	3.90	—	2.40	5.40	7.60	0.55	2.02	2.60	2.44	8.96	11.50	2.67	6.90	A++
	2.5	2.5	—	2.60	2.60	—	2.00	5.20	7.40	0.55	1.52	2.60	2.44	6.74	11.50	3.42	6.90	A++
	2.5	3.5	—	2.60	3.60	—	2.00	6.20	7.60	0.55	1.79	2.60	2.44	7.94	11.50	3.46	6.90	A++
	2.5	4.2	—	2.01	3.39	—	2.40	5.40	7.60	0.55	2.02	2.60	2.44	8.96	11.50	2.67	7.00	A++
	2.5	5.0	—	1.80	3.60	—	2.40	5.40	7.60	0.55	2.00	2.60	2.44	8.87	11.50	2.70	7.00	A++
	3.5	3.5	—	3.40	3.40	—	2.40	6.80	7.60	0.55	2.00	2.60	2.44	8.87	11.50	3.40	7.00	A++
	3.5	4.2	—	2.43	2.97	—	2.40	5.40	7.60	0.55	1.82	2.60	2.44	8.07	11.50	2.97	7.20	A++
	3.5	5.0	—	2.21	3.19	—	2.40	5.40	7.60	0.55	1.82	2.60	2.44	8.07	11.50	2.97	7.40	A++
4.2	4.2	—	2.70	2.70	—	2.40	5.40	7.60	0.55	1.82	2.60	2.44	8.07	11.50	2.97	7.40	A++	
3	3rd indoor unit is the DHW tank - this table doesnt apply for DHW TANK																	

HEATING																		
Combinations			Output power (kW)			System output power (kW)			Absorbed power (kW)			Absorbed current (A)			EER	SEER	Energy class	
IU	A	B	C	A	B	C	Min	Nom	Max	Min	Nom	Max	Min	Nom	Max			
1	2.0	—	—	2.30	—	—	0.80	2.30	4.00	0.55	0.64	1.40	2.44	2.82	5.90	—	—	—
	2.5	—	—	3.60	—	—	0.80	3.60	6.00	0.55	0.98	1.50	2.44	4.33	6.33	—	—	—
	3.5	—	—	4.50	—	—	1.00	4.50	6.00	0.55	1.22	1.65	2.44	5.40	6.96	—	—	—
	4.2	—	—	5.40	—	—	1.50	5.40	6.00	0.55	1.45	1.90	2.44	6.41	8.01	—	—	—
	5.0	—	—	6.00	—	—	1.50	6.00	8.00	0.55	1.60	2.00	2.44	7.08	8.43	—	—	—
	7.1	—	—	7.00	—	—	1.50	7.00	8.50	0.55	1.84	2.20	2.44	8.14	9.28	—	—	—
2	2.0	2.0	—	2.30	2.30	—	2.60	4.60	8.00	0.55	1.25	2.00	2.44	5.53	8.43	4.00	3.80	A
	2.0	2.5	—	2.30	3.60	—	2.70	5.90	8.50	0.55	1.60	2.00	2.44	7.08	8.43	4.25	3.80	A
	2.0	3.5	—	2.30	4.50	—	2.70	6.80	8.50	0.55	1.82	2.10	2.44	8.05	8.86	4.05	3.80	A
	2.0	4.2	—	1.49	3.51	—	2.90	5.00	8.50	0.55	2.00	2.10	2.44	8.85	8.86	4.05	3.90	A
	2.0	5.0	—	1.39	3.61	—	2.90	5.00	8.50	0.55	2.00	2.10	2.44	8.85	8.86	4.05	3.90	A
	2.5	2.5	—	3.60	3.60	—	2.90	7.20	8.50	0.55	2.00	2.10	2.44	8.85	8.86	4.05	3.90	A
	2.5	3.5	—	2.22	2.78	—	2.90	5.00	8.50	0.55	2.00	2.10	2.44	8.85	8.86	4.05	3.90	A
	2.5	4.2	—	2.00	3.00	—	2.90	5.00	8.50	0.55	2.00	2.10	2.44	8.85	8.86	4.05	3.95	A
	2.5	5.0	—	1.88	3.13	—	2.90	5.00	8.50	0.55	2.00	2.10	2.44	8.85	8.86	4.05	3.95	A
	3.5	3.5	—	3.75	3.75	—	2.90	7.50	8.50	0.55	2.00	2.20	2.44	8.85	9.28	3.86	4.00	A+
	3.5	4.2	—	2.27	2.73	—	2.90	5.00	8.50	0.55	2.02	2.20	2.44	8.93	9.28	3.86	4.00	A+
	3.5	5.0	—	2.14	2.86	—	2.90	5.00	8.50	0.55	2.00	2.20	2.44	8.85	9.28	3.86	4.10	A+
4.2	4.2	—	2.50	2.50	—	2.90	5.00	8.50	0.55	2.00	2.20	2.44	8.85	9.28	3.86	4.10	A+	
3	3rd indoor unit is the DHW tank - this table doesnt apply for DHW TANK																	

3S COMBINATIONS TABLE

4U70S2WR1FA (Values in the table refer to EXPERT series)

COOLING																		
Combinations				Output power (kW)			System output power (kW)			Absorbed power (kW)			Absorbed current (A)			EER	SEER	Energy class
IU	A	B	C	A	B	C	Min	Nom	Max	Min	Nom	Max	Min	Nom	Max			
1	2.0	—	—	2.00	—	—	0.80	2.00	2.80	0.55	0.62	1.30	2.44	2.75	5.75	—	—	—
	2.5	—	—	2.60	—	—	0.80	2.60	3.90	0.55	0.79	1.34	2.44	3.50	5.91	—	—	—
	3.5	—	—	3.60	—	—	1.00	3.60	5.30	0.55	1.09	1.65	2.44	4.84	7.30	—	—	—
	4.2	—	—	4.40	—	—	1.30	4.40	5.00	0.55	1.32	1.90	2.44	5.86	8.40	—	—	—
	5.0	—	—	5.20	—	—	1.40	5.20	7.00	0.55	1.55	2.00	2.44	6.88	8.85	—	—	—
	7.1	—	—	6.50	—	—	1.50	6.50	7.40	0.55	1.92	2.60	2.44	8.52	11.50	—	—	—
2	2.0	2.0	—	2.00	2.00	—	1.80	4.00	5.60	0.55	1.21	2.60	2.44	5.37	11.50	3.31	6.80	A++
	2.0	2.5	—	2.00	2.60	—	1.80	4.60	6.70	0.55	1.35	2.60	2.44	5.99	11.50	3.41	6.80	A++
	2.0	3.5	—	2.00	3.60	—	1.80	5.60	7.50	0.55	1.65	2.60	2.44	7.32	11.50	3.39	6.90	A++
	2.0	4.2	—	2.00	4.40	—	1.80	6.40	7.60	0.55	1.89	2.60	2.44	8.39	11.50	3.39	6.90	A++
	2.0	5.0	—	1.94	5.06	—	2.40	7.00	7.60	0.55	2.02	2.60	2.44	8.96	11.50	3.47	6.90	A++
	2.5	2.5	—	2.60	2.60	—	2.00	5.20	7.40	0.55	1.52	2.60	2.44	6.74	11.50	3.42	6.90	A++
	2.5	3.5	—	2.60	3.60	—	2.00	6.20	7.60	0.55	1.79	2.60	2.44	7.94	11.50	3.46	6.90	A++
	2.5	4.2	—	2.60	4.40	—	2.40	7.00	7.60	0.55	2.02	2.60	2.44	8.96	11.50	3.47	7.00	A++
	2.5	5.0	—	2.33	4.67	—	2.40	7.00	7.60	0.55	2.00	2.60	2.44	8.87	11.50	3.50	7.00	A++
	3.5	3.5	—	3.40	3.40	—	2.40	6.80	7.60	0.55	2.00	2.60	2.44	8.87	11.50	3.40	7.00	A++
	3.5	4.2	—	3.15	3.85	—	2.40	7.00	7.60	0.55	1.82	2.60	2.44	8.07	11.50	3.85	7.20	A++
	3.5	5.0	—	2.86	4.14	—	2.40	7.00	7.60	0.55	1.82	2.60	2.44	8.07	11.50	3.85	7.40	A++
	4.2	4.2	—	3.50	3.50	—	2.40	7.00	7.60	0.55	1.82	2.60	2.44	8.07	11.50	3.85	7.40	A++
	3	2.0	2.0	2.0	2.00	2.00	2.00	2.40	6.00	7.60	0.55	1.75	2.60	2.44	7.76	11.50	3.43	7.60
2.0		2.0	2.5	2.00	2.00	2.60	2.40	6.60	7.60	0.55	1.75	2.60	2.44	7.76	11.50	3.77	7.80	A++
2.0		2.0	3.5	1.84	1.84	3.32	2.40	7.00	7.60	0.55	1.80	2.60	2.44	7.99	11.50	3.89	7.80	A++
2.0		2.0	4.2	1.67	1.67	3.67	2.40	7.00	7.60	0.55	1.80	2.60	2.44	7.99	11.50	3.89	8.00	A++
2.0		2.0	5.0	1.52	1.52	3.96	2.40	7.00	7.60	0.55	1.80	2.60	2.44	7.99	11.50	3.89	8.00	A++
2.0		2.5	2.5	1.94	2.53	2.53	2.40	7.00	7.60	0.55	1.80	2.60	2.44	7.99	11.50	3.89	8.20	A++
2.0		2.5	3.5	1.71	2.22	3.07	2.40	7.00	7.60	0.55	1.80	2.60	2.44	7.99	11.50	3.89	8.20	A++
2.0		2.5	4.2	1.56	2.02	3.42	2.40	7.00	7.60	0.55	1.80	2.60	2.44	7.99	11.50	3.89	8.30	A++
2.0		2.5	5.0	1.43	1.86	3.71	2.40	7.00	7.60	0.55	1.82	2.60	2.44	8.07	11.50	3.85	8.30	A++
2.0		3.5	3.5	1.52	2.74	2.74	2.40	7.00	7.60	0.55	1.82	2.60	2.44	8.07	11.50	3.85	8.40	A++
2.0		3.5	4.2	1.40	2.52	3.08	2.40	7.00	7.60	0.55	1.80	2.60	2.44	7.99	11.50	3.89	8.40	A++
2.5		2.5	2.5	2.33	2.33	2.33	2.40	7.00	7.60	0.55	1.75	2.60	2.44	7.80	11.50	4.00	8.50	A+++
2.5		2.5	3.5	2.07	2.07	2.86	2.40	7.00	7.60	0.55	1.75	2.60	2.44	7.80	11.50	4.00	8.50	A+++
2.5		2.5	4.2	1.90	1.90	3.21	2.40	7.00	7.60	0.55	1.75	2.60	2.44	7.80	11.50	4.00	8.50	A+++
2.5		3.5	3.5	1.86	2.57	2.57	2.40	7.00	7.60	0.55	1.75	2.60	2.44	7.80	11.50	4.00	8.50	A+++
4		4th indoor unit is the DHW tank - this table doesnt apply for DHW TANK																

HEATING																		
Combinations				Output power (kW)			System output power (kW)			Absorbed power (kW)			Absorbed current (A)			EER	SEER	Energy class
IU	A	B	C	A	B	C	Min	Nom	Max	Min	Nom	Max	Min	Nom	Max			
1	2.0	—	—	2.30	—	—	0.80	2.30	4.00	0.55	0.64	1.40	2.44	2.82	5.90	—	—	—
	2.5	—	—	3.60	—	—	0.80	3.60	6.00	0.55	0.98	1.50	2.44	4.33	6.33	—	—	—
	3.5	—	—	4.50	—	—	1.00	4.50	6.00	0.55	1.22	1.65	2.44	5.40	6.96	—	—	—
	4.2	—	—	5.40	—	—	1.50	5.40	6.00	0.55	1.45	1.90	2.44	6.41	8.01	—	—	—
	5.0	—	—	6.00	—	—	1.50	6.00	8.00	0.55	1.60	2.00	2.44	7.08	8.43	—	—	—
	7.1	—	—	7.00	—	—	1.50	7.00	8.50	0.55	1.84	2.20	2.44	8.14	9.28	—	—	—
2	2.0	2.0	—	2.30	2.30	—	2.60	4.60	8.00	0.55	1.25	2.00	2.44	5.53	8.43	4.00	3.80	A
	2.0	2.5	—	2.30	3.60	—	2.70	5.90	8.50	0.55	1.60	2.00	2.44	7.08	8.43	4.25	3.80	A
	2.0	3.5	—	2.30	4.50	—	2.70	6.80	8.50	0.55	1.82	2.10	2.44	8.05	8.86	4.05	3.80	A
	2.0	4.2	—	1.79	4.21	—	2.90	6.00	8.50	0.55	2.00	2.10	2.44	8.85	8.86	4.05	3.90	A
	2.0	5.0	—	1.66	4.34	—	2.90	6.00	8.50	0.55	2.00	2.10	2.44	8.85	8.86	4.05	3.90	A
	2.5	2.5	—	3.60	3.60	—	2.90	7.20	8.50	0.55	2.00	2.10	2.44	8.85	8.86	4.05	3.90	A
	2.5	3.5	—	2.67	3.33	—	2.90	6.00	8.50	0.55	2.00	2.10	2.44	8.85	8.86	4.05	3.90	A
	2.5	4.2	—	2.40	3.60	—	2.90	6.00	8.50	0.55	2.00	2.10	2.44	8.85	8.86	4.05	3.95	A
	2.5	5.0	—	2.25	3.75	—	2.90	6.00	8.50	0.55	2.00	2.10	2.44	8.85	8.86	4.05	3.95	A
	3.5	3.5	—	3.75	3.75	—	2.90	7.50	8.50	0.55	2.00	2.20	2.44	8.85	9.28	3.86	4.00	A+
	3.5	4.2	—	2.73	3.27	—	2.90	6.00	8.50	0.55	2.02	2.20	2.44	8.93	9.28	3.86	4.00	A+
	3.5	5.0	—	2.57	3.43	—	2.90	6.00	8.50	0.55	2.00	2.20	2.44	8.85	9.28	3.86	4.10	A+
	4.2	4.2	—	3.00	3.00	—	2.90	6.00	8.50	0.55	2.00	2.20	2.44	8.85	9.28	3.86	4.10	A+
	3	2.0	2.0	2.0	2.30	2.30	2.30	2.90	6.90	8.50	0.55	1.85	2.30	2.44	8.18	9.70	3.70	4.20
2.0		2.0	2.5	1.68	1.68	2.63	2.90	6.00	8.50	0.55	1.98	2.30	2.44	8.76	9.70	3.70	4.20	A+
2.0		2.0	3.5	1.52	1.52	2.97	2.90	6.00	8.50	0.55	1.96	2.30	2.44	8.67	9.70	3.70	4.20	A+
2.0		2.0	4.2	1.38	1.38	3.24	2.90	6.00	8.50	0.55	1.95	2.30	2.44	8.62	9.70	3.70	4.30	A+
2.0		2.0	5.0	1.30	1.30	3.40	2.90	6.00	8.50	0.55	1.95	2.30	2.44	8.62	9.70	3.70	4.30	A+
2.0		2.5	2.5	1.45	2.27	2.27	2.90	6.00	8.50	0.55	1.93	2.30	2.44	8.54	9.70	3.70	4.30	A+
2.0		2.5	3.5	1.33	2.08	2.60	2.90	6.00	8.50	0.55	1.95	2.30	2.44	8.62	9.70	3.70	4.35	A+
2.0		2.5	4.2	1.22	1.91	2.87	2.90	6.00	8.50	0.55	1.93	2.30	2.44	8.54	9.70	3.70	4.35	A+
2.0		2.5	5.0	1.16	1.82	3.03	2.90	6.00	8.50	0.55	1.94	2.30	2.44	8.58	9.70	3.70	4.35	A+
2.0		3.5	3.5	1.22	2.39	2.39	2.90	6.00	8.50	0.55	1.93	2.30	2.44	8.54	9.70	3.70	4.35	A+
2.0		3.5	4.2	1.13	2.21	2.66	2.90	6.00	8.50	0.55	1.92	2.30	2.44	8.49	9.70	3.70	4.35	A+
2.5		2.5	2.5	2.00	2.00	2.00	2.90	6.00	8.50	0.55	1.90	2.30	2.44	8.40	9.70	3.70	4.40	A+
2.5		2.5	3.5	1.85	1.85	2.31	2.90	6.00	8.50	0.55	1.90	2.30	2.44	8.40	9.70	3.70	4.40	A+
2.5		2.5	4.2	1.71	1.71	2.57	2.90	6.00	8.50	0.55	1.90	2.30	2.44	8.40	9.70	3.70	4.40	A+
2.5		3.5	3.5	1.71	2.14	2.14	2.90	6.00	8.50	0.55	1.90	2.30	2.44	8.40	9.70	3.70	4.40	A+
4		4th indoor unit is the DHW tank - this table doesnt apply for DHW TANK																

The data in this catalogue is purely indicative as the data may vary. Please be advised to check the accuracy of the data with the supplier before purchasing products.

MULTISPLIT COMBINATIONS TABLE

2U40S2SM1FA Inverter (Values in the table refer to FLEXIS PLUS series)

COOLING																
Combinations			Output power (kW)		System output power (kW)			Absorbed power (kW)			Absorbed current (A)			EER	SEER	Energy class
IU	A	B	A	B	Min	Nom	Max	Min	Nom	Max	Min	Nom	Max			
2	2,00	2,00	1,90	1,90	1,10	3,80	4,60	0,29	0,94	1,60	1,20	4,30	7,20	4,04	6,20	A++
	2,00	2,50	1,75	2,05	1,10	3,80	4,60	0,30	0,94	1,61	1,30	4,30	7,30	4,04	6,20	A++
	2,00	3,50	1,55	2,35	1,10	3,90	4,70	0,30	0,97	1,63	1,30	4,50	7,40	4,03	6,20	A++
	2,50	2,50	2,00	2,00	1,10	4,00	4,70	0,30	0,99	1,63	1,30	4,50	7,40	4,04	6,20	A++
	2,50	3,50	1,90	2,10	1,10	4,00	4,80	0,30	0,99	1,65	1,30	4,50	7,50	4,04	6,20	A++

HEATING																
Combinations			Output power (kW)		System output power (kW)			Absorbed power (kW)			Absorbed current (A)			COP	SCOP	Energy class
IU	A	B	A	B	Min	Nom	Max	Min	Nom	Max	Min	Nom	Max			
2	2,00	2,00	2,10	2,10	1,80	4,20	4,80	0,38	1,03	2,20	1,70	4,90	9,80	4,09	4,00	A+
	2,00	2,50	1,90	2,30	1,80	4,20	4,90	0,38	1,03	2,22	1,70	4,90	9,90	4,09	4,00	A+
	2,00	3,50	1,80	2,60	1,80	4,40	5,00	0,38	1,08	2,22	1,70	5,10	9,90	4,08	4,00	A+
	2,50	2,50	2,20	2,20	1,80	4,40	5,00	0,38	1,08	2,23	1,70	5,20	10,00	4,09	4,00	A+
	2,50	3,50	2,00	2,40	1,80	4,40	5,20	0,38	1,07	2,25	1,70	5,30	10,10	4,10	4,00	A+

2U40S2SM1FA Inverter (Values in the table refer to PEARL series)

COOLING																
Combinations			Output power (kW)		System output power (kW)			Absorbed power (kW)			Absorbed current (A)			EER	SEER	Energy class
UI	A	B	A	B	min	nom	max	min	nom	max	min	nom	max			
2	2,00	2,00	1,90	1,90	1,00	3,80	4,30	0,29	0,94	1,60	1,30	4,30	7,20	4,04	6,20	A++
	2,00	2,50	1,75	2,05	1,00	3,80	4,40	0,30	0,94	1,61	1,40	4,30	7,30	4,04	6,20	A++
	2,00	3,50	1,55	2,35	1,00	3,90	4,40	0,30	0,97	1,63	1,40	4,50	7,40	4,03	6,20	A++
	2,50	2,50	2,00	2,00	1,00	4,00	4,50	0,30	0,99	1,63	1,40	4,50	7,40	4,04	6,20	A++
	2,50	3,50	1,90	2,10	1,00	4,00	4,50	0,30	0,99	1,65	1,40	4,50	7,50	4,04	6,20	A++

HEATING																
Combinations			Output power (kW)		System output power (kW)			Absorbed power (kW)			Absorbed current (A)			COP	SCOP	Energy class
UI	A	B	A	B	min	nom	max	min	nom	max	min	nom	max			
2	2,00	2,00	2,10	2,10	1,50	4,20	4,60	0,38	1,03	2,20	1,70	4,90	9,80	4,09	4,00	A+
	2,00	2,50	1,90	2,30	1,50	4,20	4,70	0,38	1,03	2,22	1,70	4,90	9,90	4,09	4,00	A+
	2,00	3,50	1,80	2,60	1,50	4,40	4,70	0,38	1,08	2,22	1,70	5,10	9,90	4,08	4,00	A+
	2,50	2,50	2,20	2,20	1,50	4,40	4,80	0,38	1,08	2,23	1,70	5,20	10,00	4,09	4,00	A+
	2,50	3,50	2,00	2,40	1,50	4,40	4,80	0,38	1,07	2,25	1,70	5,30	10,10	4,10	4,00	A+

MULTISPLIT COMBINATIONS TABLE

2U50S2SM1FA-3 Inverter (Values in the table refer to FLEXIS PLUS series)

COOLING																
Combinations			Output power (kW)		System output power (kW)			Absorbed power (kW)			Absorbed current (A)			EER	SEER	Energy class
IU	A	B	A	B	Min	Nom	Max	Min	Nom	Max	Min	Nom	Max			
2	2.00	2.00	2.45	2.45	1.30	4.90	5.60	0.33	1.35	2.36	1.56	6.00	10.58	3.63	6.50	A++
	2.00	2.50	2.20	2.70	1.30	4.90	5.60	0.33	1.36	2.37	1.56	6.10	10.62	3.60	6.50	A++
	2.00	3.50	2.00	3.00	1.30	5.00	5.80	0.35	1.43	2.51	1.65	6.30	11.25	3.50	6.50	A++
	2.00	4.20	1.90	3.10	1.30	5.00	5.80	0.35	1.43	2.51	1.65	6.30	11.25	3.50	6.50	A++
	2.00	5.00	1.80	3.20	1.30	5.00	5.80	0.35	1.43	2.51	1.65	6.30	11.25	3.50	6.50	A++
	2.50	2.50	2.50	2.50	1.30	5.00	5.80	0.35	1.43	2.51	1.64	6.30	11.25	3.50	6.50	A++
	2.50	3.50	2.20	2.80	1.30	5.00	5.80	0.35	1.39	2.52	1.64	6.20	11.30	3.60	6.50	A++
	2.50	4.20	2.10	2.90	1.30	5.00	6.00	0.35	1.43	2.55	1.64	6.30	11.43	3.50	6.50	A++
	2.50	5.00	2.00	3.00	1.30	5.00	6.00	0.35	1.43	2.55	1.64	6.30	11.43	3.50	6.50	A++
	3.50	3.50	2.50	2.50	1.30	5.00	6.00	0.35	1.43	2.55	1.64	6.30	11.50	3.50	6.50	A++
	3.50	4.20	2.40	2.70	1.30	5.10	6.10	0.35	1.46	2.57	1.64	6.50	11.52	3.50	6.50	A++
	3.50	5.00	2.40	2.80	1.30	5.20	6.20	0.35	1.49	2.60	1.64	6.70	11.65	3.50	6.50	A++
4.20	4.20	2.60	2.60	1.30	5.20	6.20	0.35	1.49	2.60	1.64	6.70	11.65	3.50	6.50	A++	

HEATING																
Combinations			Output power (kW)		System output power (kW)			Absorbed power (kW)			Absorbed current (A)			COP	SCOP	Energy class
IU	A	B	A	B	Min	Nom	Max	Min	Nom	Max	Min	Nom	Max			
2	2.00	2.00	2.50	2.50	1.50	5.00	6.30	0.49	1.35	2.71	2.20	6.70	12.15	3.71	4.00	A+
	2.00	2.50	2.40	2.60	1.50	5.00	6.30	0.49	1.35	2.72	2.20	6.80	12.19	3.71	4.00	A+
	2.00	3.50	2.50	2.70	1.60	5.20	6.40	0.52	1.40	2.73	2.30	7.00	12.24	3.71	4.00	A+
	2.00	4.20	2.40	2.80	1.60	5.20	6.50	0.52	1.40	2.76	2.30	6.90	12.37	3.71	4.00	A+
	2.00	5.00	2.30	2.90	1.60	5.20	6.50	0.52	1.40	2.76	2.30	6.90	12.37	3.71	4.00	A+
	2.50	2.50	2.60	2.60	1.60	5.20	6.50	0.52	1.40	2.76	2.30	6.90	12.37	3.71	4.00	A+
	2.50	3.50	2.50	2.70	1.70	5.20	6.60	0.53	1.40	2.77	2.40	6.90	12.42	3.71	4.00	A+
	2.50	4.20	2.40	2.80	1.80	5.20	6.60	0.55	1.40	2.80	2.50	6.80	12.50	3.71	4.00	A+
	2.50	5.00	2.20	3.00	1.80	5.20	6.60	0.55	1.40	2.80	2.50	6.80	12.50	3.71	4.00	A+
	3.50	3.50	2.60	2.60	1.80	5.20	6.60	0.55	1.40	2.80	2.50	6.80	12.55	3.71	4.00	A+
	3.50	4.20	2.50	2.80	1.80	5.30	6.70	0.55	1.43	2.82	2.50	6.80	12.64	3.71	4.00	A+
	3.50	5.00	2.40	3.00	1.80	5.40	6.80	0.55	1.46	2.85	2.50	6.80	12.77	3.71	4.00	A+
4.20	4.20	2.70	2.70	1.80	5.40	6.80	0.55	1.46	2.85	2.50	6.80	12.77	3.71	4.00	A+	

2U50S2SM1FA-3 Inverter (Values in the table refer to PEARL series)

COOLING																
Combinations			Output power (kW)		System output power (kW)			Absorbed power (kW)			Absorbed current (A)			EER	SEER	Energy class
UI	A	B	A	B	min	nom	max	min	nom	max	min	nom	max			
2	2.00	2.00	2.35	2.35	1.10	4.70	5.10	0.33	1.34	2.08	1.56	6.08	9.32	3.50	6.10	A++
	2.00	2.50	2.10	2.60	1.10	4.70	5.10	0.33	1.34	2.08	1.56	6.08	9.32	3.50	6.10	A++
	2.00	3.50	1.90	2.90	1.10	4.80	5.20	0.35	1.39	2.10	1.65	6.30	9.41	3.45	6.10	A++
	2.00	5.00	1.70	3.10	1.10	4.80	5.20	0.35	1.39	2.10	1.65	6.30	9.41	3.45	6.10	A++
	2.50	2.50	2.40	2.40	1.10	4.80	5.20	0.35	1.39	2.10	1.64	6.30	9.41	3.45	6.10	A++
	2.50	3.50	2.10	2.70	1.10	4.80	5.20	0.35	1.39	2.10	1.64	6.30	9.41	3.45	6.10	A++
	2.50	5.00	1.90	2.90	1.10	4.80	5.40	0.35	1.39	2.10	1.64	6.30	9.41	3.45	6.10	A++
	3.50	3.50	2.40	2.40	1.10	4.80	5.40	0.35	1.39	2.10	1.64	6.30	9.41	3.45	6.10	A++
	3.50	5.00	2.30	2.70	1.10	5.00	5.50	0.35	1.45	2.30	1.64	6.56	10.31	3.45	6.10	A++

HEATING																
Combinations			Output power (kW)		System output power (kW)			Absorbed power (kW)			Absorbed current (A)			COP	SCOP	Energy class
UI	A	B	A	B	min	nom	max	min	nom	max	min	nom	max			
2	2.00	2.00	2.40	2.40	1.30	4.80	5.70	0.49	1.29	2.35	2.20	5.80	10.53	3.71	4.00	A+
	2.00	2.50	2.30	2.50	1.30	4.80	5.70	0.49	1.29	2.35	2.20	5.80	10.53	3.71	4.00	A+
	2.00	3.50	2.40	2.60	1.40	5.00	5.80	0.52	1.35	2.35	2.30	6.04	10.53	3.71	4.00	A+
	2.00	5.00	2.20	2.80	1.40	5.00	5.80	0.52	1.35	2.37	2.30	6.04	10.62	3.71	4.00	A+
	2.50	2.50	2.50	2.50	1.40	5.00	5.80	0.52	1.35	2.37	2.30	6.04	10.62	3.71	4.00	A+
	2.50	3.50	2.40	2.60	1.50	5.00	5.90	0.53	1.35	2.37	2.40	6.04	10.62	3.71	4.00	A+
	2.50	5.00	2.10	2.90	1.60	5.00	5.90	0.55	1.35	2.40	2.50	6.04	12.50	3.71	4.00	A+
	3.50	3.50	2.50	2.50	1.60	5.00	5.90	0.55	1.35	2.40	2.50	6.04	10.76	3.71	4.00	A+
	3.50	5.00	2.30	2.90	1.70	5.20	6.00	0.55	1.40	2.50	2.50	6.28	11.21	3.71	4.00	A+

MULTISPLIT COMBINATIONS TABLE

3U55S2SR5FA Inverter (Values in the table refer to FLEXIS PLUS)

COOLING																		
Combinations				Output power (kW)			System output power (kW)			Absorbed power (kW)			Absorbed current (A)			EER	SEER	Energy class
UI	A	B	C	A	B	C	min	nom	max	min	nom	max	min	nom	max			
2	2,00	2,00	—	2,00	2,00	—	1,60	4,00	5,60	0,55	1,18	2,50	2,44	5,38	10,80	3,39	6,80	A++
	2,00	2,50	—	2,00	2,60	—	1,80	4,60	6,60	0,55	1,28	2,50	2,44	5,84	10,80	3,59	6,80	A++
	2,00	3,50	—	1,79	3,21	—	2,10	5,00	6,60	0,55	1,36	2,50	2,44	6,20	10,80	3,68	7,00	A++
	2,00	4,20	—	1,56	3,44	—	2,10	5,00	6,60	0,55	1,36	2,50	2,44	6,20	10,80	3,68	7,00	A++
	2,00	5,00	—	1,39	3,61	—	2,10	5,00	6,60	0,55	1,36	2,50	2,44	6,20	10,80	3,68	7,00	A++
	2,50	2,50	—	2,50	2,50	—	2,00	5,00	6,60	0,55	1,36	2,50	2,44	6,20	10,80	3,68	7,00	A++
	2,50	3,50	—	2,10	2,90	—	2,10	5,00	6,60	0,55	1,34	2,50	2,44	6,11	10,80	3,73	7,00	A++
	2,50	4,20	—	1,86	3,14	—	2,10	5,00	6,60	0,55	1,34	2,50	2,44	6,11	10,80	3,73	7,40	A++
3	2,50	5,00	—	1,67	3,33	—	2,10	5,00	6,60	0,55	1,34	2,50	2,44	6,11	10,80	3,73	7,80	A++
	3,50	3,50	—	2,50	2,50	—	2,10	5,00	6,60	0,55	1,34	2,50	2,44	6,11	10,80	3,73	7,80	A++
	2,00	2,00	2,00	1,67	1,67	1,67	2,10	5,00	6,60	0,55	1,29	2,50	2,44	5,89	10,80	3,88	7,60	A++
	2,00	2,00	2,50	1,52	1,52	1,97	2,10	5,00	6,60	0,55	1,29	2,50	2,44	5,89	10,80	3,88	8,00	A++
	2,00	2,00	3,50	1,32	1,32	2,37	2,10	5,00	6,60	0,55	1,27	2,50	2,44	5,79	10,80	3,94	8,00	A++
	2,00	2,50	2,50	1,39	1,81	1,81	2,10	5,00	6,60	0,55	1,27	2,50	2,44	5,79	10,80	3,94	8,30	A++
	2,00	2,50	3,50	1,22	1,59	2,20	2,10	5,00	6,60	0,55	1,27	2,50	2,44	5,79	10,80	3,94	8,30	A++
	2,50	2,50	2,50	1,67	1,67	1,67	2,10	5,00	6,60	0,55	1,25	2,50	2,44	5,70	10,80	4,00	8,50	A+++
2,50	2,50	3,50	1,48	1,48	2,05	2,10	5,00	6,60	0,55	1,25	2,50	2,44	5,70	10,80	4,00	8,50	A+++	

HEATING																		
Combinations				Output power (kW)			System output power (kW)			Absorbed power (kW)			Absorbed current (A)			COP	SCOP	Energy class
UI	A	B	C	A	B	C	min	nom	max	min	nom	max	min	nom	max			
2	2,00	2,00	—	2,30	2,30	—	1,20	4,60	7,20	0,55	1,25	2,10	2,44	5,47	9,07	3,68	3,90	A
	2,00	2,50	—	2,30	3,60	—	1,20	5,90	7,20	0,55	1,54	2,10	2,44	6,74	9,07	3,83	3,95	A
	2,00	3,50	—	2,16	4,24	—	1,20	6,40	7,20	0,55	1,72	2,10	2,44	7,52	9,07	3,72	3,95	A
	2,00	4,20	—	1,91	4,49	—	1,70	6,40	7,20	0,55	1,70	2,10	2,44	7,44	9,07	3,76	3,95	A
	2,00	5,00	—	1,77	4,63	—	1,70	6,40	7,20	0,55	1,70	2,10	2,44	7,44	9,07	3,76	3,95	A
	2,50	2,50	—	3,20	3,20	—	1,70	6,40	7,20	0,55	1,68	2,20	2,44	7,35	9,50	3,81	4,00	A+
	2,50	3,50	—	2,84	3,56	—	1,70	6,40	7,20	0,55	1,68	2,20	2,44	7,35	9,50	3,81	4,00	A+
	2,50	4,20	—	2,56	3,84	—	1,70	6,40	7,20	0,55	1,66	2,20	2,44	7,26	9,50	3,86	4,10	A+
	2,50	5,00	—	2,40	4,00	—	1,70	6,40	7,20	0,55	1,66	2,20	2,44	7,26	9,50	3,86	4,20	A+
3	3,50	3,50	—	3,20	3,20	—	1,70	6,40	7,20	0,55	1,66	2,20	2,44	7,26	9,50	3,86	4,20	A+
	2,00	2,00	2,00	2,13	2,13	2,13	1,70	6,40	7,20	0,55	1,64	2,20	2,44	7,17	9,50	3,90	4,30	A+
	2,00	2,00	2,50	1,80	1,80	2,81	1,70	6,40	7,20	0,55	1,63	2,20	2,44	7,13	9,50	3,93	4,40	A+
	2,00	2,00	3,50	1,62	1,62	3,16	1,70	6,40	7,20	0,55	1,63	2,20	2,44	7,13	9,50	3,93	4,40	A+
	2,00	2,50	2,50	1,55	2,43	2,43	1,70	6,40	7,20	0,55	1,62	2,20	2,44	7,09	9,50	3,95	4,50	A+
	2,00	2,50	3,50	1,42	2,22	2,77	1,70	6,40	7,20	0,55	1,62	2,20	2,44	7,09	9,50	3,95	4,50	A+
	2,50	2,50	2,50	2,13	2,13	2,13	1,70	6,40	7,20	0,55	1,60	2,20	2,44	7,00	9,50	4,00	4,60	A++
2,50	2,50	3,50	1,97	1,97	2,46	1,70	6,40	7,20	0,55	1,60	2,20	2,44	7,00	9,50	4,00	4,60	A++	

MULTISPLIT COMBINATIONS TABLE

3U70S2SR5FA Inverter (Values in the table refer to FLEXIS PLUS)

COOLING																		
Combinations				Output power (kW)			System output power (kW)			Absorbed power (kW)			Absorbed current (A)			EER	SEER	Energy class
UI	A	B	C	A	B	C	Min	nom.	Max	Min	nom.	Max	Min	nom.	Max			
2	2,00	2,00	—	2,00	2,00	—	1,80	4,00	5,60	0,55	1,21	2,60	2,44	5,37	11,50	3,31	6,80	A++
	2,00	2,50	—	2,00	2,60	—	1,80	4,60	6,70	0,55	1,35	2,60	2,44	5,99	11,50	3,41	6,80	A++
	2,00	3,50	—	2,00	3,60	—	1,80	5,60	7,50	0,55	1,65	2,60	2,44	7,32	11,50	3,39	6,90	A++
	2,00	4,20	—	2,00	4,40	—	1,80	6,40	7,60	0,55	1,89	2,60	2,44	8,39	11,50	3,39	6,90	A++
	2,00	5,00	—	1,94	5,06	—	2,40	7,00	7,60	0,55	2,02	2,60	2,44	8,96	11,50	3,47	6,90	A++
	2,50	2,50	—	2,60	2,60	—	2,00	5,20	7,40	0,55	1,52	2,60	2,44	6,74	11,50	3,42	6,90	A++
	2,50	3,50	—	2,60	3,60	—	2,00	6,20	7,60	0,55	1,79	2,60	2,44	7,94	11,50	3,46	6,90	A++
	2,50	4,20	—	2,60	4,40	—	2,40	7,00	7,60	0,55	2,02	2,60	2,44	8,96	11,50	3,47	7,00	A++
	2,50	5,00	—	2,33	4,67	—	2,40	7,00	7,60	0,55	2,00	2,60	2,44	8,87	11,50	3,50	7,00	A++
	3,50	3,50	—	3,40	3,40	—	2,40	6,80	7,60	0,55	2,00	2,60	2,44	8,87	11,50	3,40	7,00	A++
	3,50	4,20	—	3,15	3,85	—	2,40	7,00	7,60	0,55	1,82	2,60	2,44	8,07	11,50	3,85	7,20	A++
	3,50	5,00	—	2,86	4,14	—	2,40	7,00	7,60	0,55	1,82	2,60	2,44	8,07	11,50	3,85	7,40	A++
4,20	4,20	—	3,50	3,50	—	2,40	7,00	7,60	0,55	1,82	2,60	2,44	8,07	11,50	3,85	7,40	A++	
3	2,00	2,00	2,00	2,00	2,00	2,00	2,40	6,00	7,60	0,55	1,75	2,60	2,44	7,76	11,50	3,43	7,60	A++
	2,00	2,00	2,50	2,00	2,00	2,60	2,40	6,60	7,60	0,55	1,75	2,60	2,44	7,76	11,50	3,77	7,80	A++
	2,00	2,00	3,50	1,84	1,84	3,32	2,40	7,00	7,60	0,55	1,80	2,60	2,44	7,99	11,50	3,89	7,80	A++
	2,00	2,00	4,20	1,67	1,67	3,67	2,40	7,00	7,60	0,55	1,80	2,60	2,44	7,99	11,50	3,89	8,00	A++
	2,00	2,00	5,00	1,52	1,52	3,96	2,40	7,00	7,60	0,55	1,80	2,60	2,44	7,99	11,50	3,89	8,00	A++
	2,00	2,50	2,50	1,94	2,53	2,53	2,40	7,00	7,60	0,55	1,80	2,60	2,44	7,99	11,50	3,89	8,20	A++
	2,00	2,50	3,50	1,71	2,22	3,07	2,40	7,00	7,60	0,55	1,80	2,60	2,44	7,99	11,50	3,89	8,20	A++
	2,00	2,50	4,20	1,56	2,02	3,42	2,40	7,00	7,60	0,55	1,80	2,60	2,44	7,99	11,50	3,89	8,30	A++
	2,00	2,50	5,00	1,43	1,86	3,71	2,40	7,00	7,60	0,55	1,82	2,60	2,44	8,07	11,50	3,85	8,30	A++
	2,00	3,50	3,50	1,52	2,74	2,74	2,40	7,00	7,60	0,55	1,82	2,60	2,44	8,07	11,50	3,85	8,40	A++
	2,00	3,50	4,20	1,40	2,52	3,08	2,40	7,00	7,60	0,55	1,80	2,60	2,44	7,99	11,50	3,89	8,40	A++
	2,50	2,50	2,50	2,33	2,33	2,33	2,40	7,00	7,60	0,55	1,75	2,60	2,44	7,80	11,50	4,00	8,50	A+++
	2,50	2,50	3,50	2,07	2,07	2,86	2,40	7,00	7,60	0,55	1,75	2,60	2,44	7,80	11,50	4,00	8,50	A+++
	2,50	2,50	4,20	1,90	1,90	3,21	2,40	7,00	7,60	0,55	1,75	2,60	2,44	7,80	11,50	4,00	8,50	A+++
2,50	3,50	3,50	1,86	2,57	2,57	2,40	7,00	7,60	0,55	1,75	2,60	2,44	7,80	11,50	4,00	8,50	A+++	

HEATING																		
Combinations				Output power (kW)			System output power (kW)			Absorbed power (kW)			Absorbed current (A)			COP	SCOP	Energy class
UI	A	B	C	A	B	C	min	nom	max	min	nom	max	min	nom	max			
2	2,00	2,00	—	2,30	2,30	—	2,60	4,60	8,00	0,55	1,25	2,00	2,44	5,53	8,43	3,68	3,80	A
	2,00	2,50	—	2,30	3,60	—	2,70	5,90	8,50	0,55	1,60	2,00	2,44	7,08	8,43	3,69	3,80	A
	2,00	3,50	—	2,30	4,50	—	2,70	6,80	8,50	0,55	1,82	2,10	2,44	8,05	8,86	3,74	3,80	A
	2,00	4,20	—	2,27	5,33	—	2,90	7,60	8,50	0,55	2,00	2,10	2,44	8,85	8,86	3,80	3,90	A
	2,00	5,00	—	2,11	5,49	—	2,90	7,60	8,50	0,55	2,00	2,10	2,44	8,85	8,86	3,80	3,90	A
	2,50	2,50	—	3,60	3,60	—	2,90	7,20	8,50	0,55	2,00	2,10	2,44	8,85	8,86	3,60	3,90	A
	2,50	3,50	—	3,38	4,22	—	2,90	7,60	8,50	0,55	2,00	2,10	2,44	8,85	8,86	3,80	3,90	A
	2,50	4,20	—	3,04	4,56	—	2,90	7,60	8,50	0,55	2,00	2,10	2,44	8,85	8,86	3,80	3,95	A
	2,50	5,00	—	2,85	4,75	—	2,90	7,60	8,50	0,55	2,00	2,10	2,44	8,85	8,86	3,80	3,95	A
	3,50	3,50	—	3,75	3,75	—	2,90	7,50	8,50	0,55	2,00	2,20	2,44	8,85	9,28	3,75	4,00	A+
	3,50	4,20	—	3,45	4,15	—	2,90	7,60	8,50	0,55	2,02	2,20	2,44	8,93	9,28	3,76	4,00	A+
	3,50	5,00	—	3,26	4,34	—	2,90	7,60	8,50	0,55	2,00	2,20	2,44	8,85	9,28	3,80	4,10	A+
4,20	4,20	—	3,80	3,80	—	2,90	7,60	8,50	0,55	2,00	2,20	2,44	8,85	9,28	3,80	4,10	A+	
3	2,00	2,00	2,00	2,30	2,30	2,30	2,90	6,90	8,50	0,55	1,85	2,30	2,44	8,18	9,70	3,73	4,20	A+
	2,00	2,00	2,50	2,13	2,13	3,34	2,90	7,60	8,50	0,55	1,98	2,30	2,44	8,76	9,70	3,84	4,20	A+
	2,00	2,00	3,50	1,92	1,92	3,76	2,90	7,60	8,50	0,55	1,96	2,30	2,44	8,67	9,70	3,88	4,20	A+
	2,00	2,00	4,20	1,75	1,75	4,10	2,90	7,60	8,50	0,55	1,95	2,30	2,44	8,62	9,70	3,90	4,30	A+
	2,00	2,00	5,00	1,65	1,65	4,30	2,90	7,60	8,50	0,55	1,95	2,30	2,44	8,62	9,70	3,90	4,30	A+
	2,00	2,50	2,50	1,84	2,88	2,88	2,90	7,60	8,50	0,55	1,93	2,30	2,44	8,54	9,70	3,94	4,30	A+
	2,00	2,50	3,50	1,68	2,63	3,29	2,90	7,60	8,50	0,55	1,95	2,30	2,44	8,62	9,70	3,90	4,40	A+
	2,00	2,50	4,20	1,55	2,42	3,63	2,90	7,60	8,50	0,55	1,93	2,30	2,44	8,54	9,70	3,94	4,40	A+
	2,00	2,50	5,00	1,47	2,30	3,83	2,90	7,60	8,50	0,55	1,94	2,30	2,44	8,58	9,70	3,92	4,40	A+
	2,00	3,50	3,50	1,55	3,03	3,03	2,90	7,60	8,50	0,55	1,93	2,30	2,44	8,54	9,70	3,94	4,50	A+
	2,00	3,50	4,20	1,43	2,80	3,36	2,90	7,60	8,50	0,55	1,92	2,30	2,44	8,49	9,70	3,96	4,50	A+
	2,50	2,50	2,50	2,53	2,53	2,53	2,90	7,60	8,50	0,55	1,90	2,30	2,44	8,40	9,70	4,00	4,60	A++
	2,50	2,50	3,50	2,34	2,34	2,92	2,90	7,60	8,50	0,55	1,90	2,30	2,44	8,40	9,70	4,00	4,60	A++
	2,50	2,50	4,20	2,17	2,17	3,26	2,90	7,60	8,50	0,55	1,90	2,30	2,44	8,40	9,70	4,00	4,60	A++
2,50	3,50	3,50	2,17	2,71	2,71	2,90	7,60	8,50	0,55	1,90	2,30	2,44	8,40	9,70	4,00	4,60	A++	

MULTISPLIT COMBINATIONS TABLE

4U75S2SR5FA Inverter (The values in the table refer to the FLEXIS series)

COOLING																					
Combinations				Output power (kW)				System output power (kW)			Absorbed power (kW)			Absorbed current (A)			EER	SEER	Energy class		
UI	A	B	C	D	A	B	C	D	max	min	nom	max	min	nom	max	min	nom				
2	2,00	2,00	—	—	2,00	2,00	—	—	2,00	4,00	5,60	0,55	1,30	3,00	2,44	5,77	13,31	3,08	6,20	A++	
	2,00	2,50	—	—	2,00	2,60	—	—	2,00	4,60	6,70	0,55	1,50	3,00	2,44	6,65	13,31	3,07	6,20	A++	
	2,00	3,50	—	—	2,00	3,60	—	—	2,00	5,60	8,10	0,55	1,80	3,00	2,44	7,99	13,31	3,11	6,20	A++	
	2,00	4,20	—	—	2,00	4,40	—	—	2,00	6,40	7,80	0,55	1,95	3,00	2,44	8,65	13,31	3,28	6,20	A++	
	2,00	5,00	—	—	2,00	5,20	—	—	2,00	7,20	8,70	0,55	2,20	3,00	2,44	9,76	13,31	3,27	6,20	A++	
	2,00	7,10	—	—	1,76	5,74	—	—	2,00	7,50	8,70	0,55	2,24	3,10	2,44	9,94	13,75	3,35	6,20	A++	
	2,50	2,50	—	—	2,60	2,60	—	—	2,00	5,20	7,80	0,55	1,70	3,10	2,44	7,54	13,75	3,06	6,20	A++	
	2,50	3,50	—	—	2,60	3,60	—	—	2,00	6,20	8,70	0,55	2,00	3,10	2,44	8,87	13,75	3,10	6,20	A++	
	2,50	4,20	—	—	2,60	4,40	—	—	2,00	7,00	8,70	0,55	2,10	3,10	2,44	9,32	13,75	3,33	6,20	A++	
	2,50	5,00	—	—	2,50	5,00	—	—	2,00	7,50	8,70	0,55	2,24	3,10	2,44	9,94	13,75	3,35	6,20	A++	
	2,50	7,10	—	—	2,14	5,36	—	—	2,00	7,50	8,70	0,55	2,24	3,10	2,44	9,94	13,75	3,35	6,20	A++	
	3,50	3,50	—	—	3,60	3,60	—	—	2,00	7,20	8,70	0,55	2,20	3,10	2,44	9,76	13,75	3,27	6,20	A++	
	3,50	4,20	—	—	3,38	4,13	—	—	2,00	7,50	8,70	0,55	2,26	3,20	2,44	10,03	14,20	3,32	6,20	A++	
	3,50	5,00	—	—	2,95	4,25	—	—	2,00	7,20	8,70	0,55	2,24	3,20	2,44	9,94	14,20	3,21	6,20	A++	
	3,50	7,10	—	—	2,67	4,83	—	—	2,00	7,50	8,70	0,55	2,25	3,20	2,44	9,98	14,20	3,33	6,20	A++	
	4,20	4,20	—	—	3,75	3,75	—	—	2,00	7,50	8,70	0,55	2,25	3,20	2,44	9,98	14,20	3,33	6,20	A++	
	4,20	5,00	—	—	3,44	4,06	—	—	2,00	7,50	8,70	0,55	2,25	3,20	2,44	9,98	14,20	3,33	6,20	A++	
	4,20	7,10	—	—	3,03	4,47	—	—	2,00	7,50	8,70	0,55	2,25	3,30	2,44	9,98	14,64	3,33	6,20	A++	
	5,00	5,00	—	—	3,75	3,75	—	—	2,00	7,50	8,70	0,55	2,18	3,30	2,44	9,67	14,64	3,44	6,20	A++	
	5,00	7,10	—	—	3,33	4,17	—	—	2,00	7,50	8,70	0,55	2,18	3,30	2,44	9,67	14,64	3,44	6,20	A++	
3	2,00	2,00	2,00	—	2,00	2,00	2,00	—	2,40	6,00	8,70	0,55	1,80	3,40	2,44	7,99	15,08	3,33	6,70	A++	
	2,00	2,00	2,50	—	2,00	2,00	2,60	—	2,40	6,60	8,70	0,55	1,95	3,40	2,44	8,65	15,08	3,38	6,70	A++	
	2,00	2,00	3,50	—	1,97	1,97	3,55	—	2,40	7,50	8,70	0,55	2,20	3,40	2,44	9,76	15,08	3,41	6,70	A++	
	2,00	2,00	4,20	—	1,79	1,79	3,93	—	2,40	7,50	8,70	0,55	2,20	3,40	2,44	9,76	15,08	3,41	6,70	A++	
	2,00	2,00	5,00	—	1,63	1,63	4,24	—	2,40	7,50	8,70	0,55	2,20	3,40	2,44	9,76	15,08	3,41	6,70	A++	
	2,00	2,00	7,10	—	1,43	1,43	4,64	—	2,40	7,50	8,70	0,55	2,15	3,40	2,44	9,54	15,08	3,49	6,70	A++	
	2,00	2,50	2,50	—	2,00	2,60	2,60	—	2,40	7,20	8,70	0,55	2,15	3,40	2,44	9,54	15,08	3,35	6,70	A++	
	2,00	2,50	3,50	—	1,83	2,38	3,29	—	2,40	7,50	8,70	0,55	2,15	3,40	2,44	9,54	15,08	3,49	6,70	A++	
	2,00	2,50	4,20	—	1,67	2,17	3,67	—	2,40	7,50	8,70	0,55	2,15	3,40	2,44	9,54	15,08	3,49	6,70	A++	
	2,00	2,50	5,00	—	1,53	1,99	3,98	—	2,40	7,50	8,70	0,55	2,15	3,40	2,44	9,54	15,08	3,49	6,70	A++	
	2,00	2,50	7,10	—	1,35	1,76	4,39	—	2,40	7,50	8,70	0,55	2,15	3,40	2,44	9,54	15,08	3,49	6,70	A++	
	2,00	3,50	3,50	—	1,63	2,93	2,93	—	2,40	7,50	8,70	0,55	2,15	3,40	2,44	9,54	15,08	3,49	6,70	A++	
	2,00	3,50	4,20	—	1,50	2,70	3,30	—	2,40	7,50	8,70	0,55	2,15	3,40	2,44	9,54	15,08	3,49	6,70	A++	
	2,00	3,50	5,00	—	1,39	2,50	3,61	—	2,40	7,50	8,70	0,55	2,15	3,40	2,44	9,54	15,08	3,49	6,70	A++	
	2,00	3,50	7,10	—	1,24	2,23	4,03	—	2,40	7,50	8,70	0,55	2,15	3,40	2,44	9,54	15,08	3,49	6,70	A++	
	2,00	4,20	4,20	—	1,39	3,06	3,06	—	2,40	7,50	8,70	0,55	2,15	3,40	2,44	9,54	15,08	3,49	6,70	A++	
	2,00	4,20	5,00	—	1,29	2,84	3,36	—	2,40	7,50	8,70	0,55	2,15	3,40	2,44	9,54	15,08	3,49	6,70	A++	
	2,00	4,20	7,10	—	1,16	2,56	3,78	—	2,40	7,50	8,70	0,55	2,15	3,40	2,44	9,54	15,08	3,49	6,70	A++	
	2,50	2,50	2,50	—	2,50	2,50	2,50	—	2,40	7,50	8,70	0,55	2,15	3,40	2,44	9,54	15,08	3,49	6,72	A++	
	2,50	2,50	3,50	—	2,22	2,22	3,07	—	2,40	7,50	8,70	0,55	2,15	3,40	2,44	9,54	15,08	3,49	6,72	A++	
	2,50	2,50	4,20	—	2,03	2,03	3,44	—	2,40	7,50	8,70	0,55	2,15	3,40	2,44	9,54	15,08	3,49	6,74	A++	
	2,50	2,50	5,00	—	1,88	1,88	3,75	—	2,40	7,50	8,70	0,55	2,15	3,40	2,44	9,54	15,08	3,49	6,74	A++	
	2,50	2,50	7,10	—	1,67	1,67	4,17	—	2,40	7,50	8,70	0,55	2,15	3,40	2,44	9,54	15,08	3,49	6,70	A++	
	2,50	3,50	3,50	—	1,99	2,76	2,76	—	2,40	7,50	8,70	0,55	2,08	3,40	2,44	9,23	15,08	3,61	6,73	A++	
	2,50	3,50	4,20	—	1,84	2,55	3,11	—	2,40	7,50	8,70	0,55	2,08	3,40	2,44	9,23	15,08	3,61	6,70	A++	
	2,50	3,50	5,00	—	1,71	2,37	3,42	—	2,40	7,50	8,70	0,55	2,08	3,40	2,44	9,23	15,08	3,61	6,70	A++	
	2,50	3,50	7,10	—	1,54	2,13	3,84	—	2,40	7,50	8,70	0,55	2,08	3,40	2,44	9,23	15,08	3,61	6,70	A++	
	2,50	4,20	4,20	—	1,71	2,89	2,89	—	2,40	7,50	8,70	0,55	2,08	3,40	2,44	9,23	15,08	3,61	6,70	A++	
	2,50	4,20	5,00	—	1,60	2,70	3,20	—	2,40	7,50	8,70	0,55	2,08	3,40	2,44	9,23	15,08	3,61	6,70	A++	
	3,50	3,50	3,50	—	2,50	2,50	2,50	—	2,40	7,50	8,70	0,55	2,08	3,40	2,44	9,23	15,08	3,61	6,75	A++	
	3,50	3,50	4,20	—	2,33	2,33	2,84	—	2,40	7,50	8,70	0,55	2,08	3,40	2,44	9,23	15,08	3,61	6,70	A++	
	3,50	3,50	5,00	—	2,18	2,18	3,15	—	2,40	7,50	8,70	0,55	2,08	3,40	2,44	9,23	15,08	3,61	6,70	A++	
4	2,00	2,00	2,00	2,00	1,88	1,88	1,88	1,88	2,40	7,50	8,70	0,55	2,12	3,40	2,44	9,41	15,08	3,54	6,80	A++	
	2,00	2,00	2,00	2,50	1,74	1,74	1,74	2,27	2,40	7,50	8,70	0,55	2,12	3,40	2,44	9,41	15,08	3,54	6,80	A++	
	2,00	2,00	2,00	3,50	1,56	1,56	1,56	2,81	2,40	7,50	8,70	0,55	2,12	3,40	2,44	9,41	15,08	3,54	6,80	A++	
	2,00	2,00	2,00	4,20	1,44	1,44	1,44	3,17	2,40	7,50	8,70	0,55	2,12	3,40	2,44	9,41	15,08	3,54	6,80	A++	
	2,00	2,00	2,00	5,00	1,34	1,34	1,34	3,48	2,40	7,50	8,70	0,55	2,02	3,40	2,44	8,96	15,08	3,71	6,80	A++	
	2,00	2,00	2,00	7,10	1,20	1,20	1,20	3,90	2,40	7,50	8,70	0,55	2,02	3,40	2,44	8,96	15,08	3,71	6,70	A++	
	2,00	2,00	2,50	2,50	1,63	1,63	2,12	2,12	2,40	7,50	8,70	0,55	2,02	3,40	2,44	8,96	15,08	3,71	6,80	A++	
	2,00	2,00	2,50	3,50	1,47	1,47	1,91	2,65	2,40	7,50	8,70	0,55	2,02	3,40	2,44	8,96	15,08	3,71	6,80	A++	
	2,00	2,00	2,50	4,20	1,36	1,36	1,77	3,00	2,40	7,50	8,70	0,55	2,02	3,40	2,44	8,96	15,08	3,71	6,80	A++	
	2,00	2,00	2,50	5,00	1,27	1,27	1,65	3,31	2,40	7,50	8,70	0,55	2,02	3,40	2,44	8,96	15,08	3,71	6,80	A++	
	2,00	2,00	2,50	7,10	1,15	1,15	1,49	3,72	2,40	7,50	8,70	0,55	2,02	3,40	2,44	8,96	15,08	3,71	6,70	A++	
	2,00	2,00	3,50	3,50	1,34	1,34	2,41	2,41	2,40	7,50	8,70	0,55	2,02	3,40	2,44	8,96	15,08	3,71	6,80	A++	
	2,00	2,00	3,50	4,20	1,25	1,25	2,25	2,75	2,40	7,50	8,70	0,55	2,02	3,40	2,44	8,96	15,08	3,71	6,70	A++	
	2,00	2,00	3,50	5,00	1,17	1,17	2,11	3,05	2,40	7,50	8,70	0,55	2,02	3,40	2,44	8,96	15,08	3,71	6,70	A++	
	2,00	2,00	4,20	4,20	1,17	1,17	2,58	2,58	2,40	7,50	8,70	0,55	2,02	3,40	2,44	8,96	15,08	3,71	7,00	A++	
	2,00	2,00	4,20	5,00	1,10	1,10	2,43	2,87													

MULTISPLIT COMBINATIONS TABLE

4U75S2SR5FA Inverter (The values in the table refer to the FLEXIS series)

HEATING																					
Combinations				Output power (kW)				System output power (kW)			Absorbed power (kW)			Absorbed current (A)			COP	SCOP	Energy class		
UI	A	B	C	D	A	B	C	D	max	min	nom	max	min	nom	max	min	nom				
2	2,00	2,00	—	—	2,30	2,30	—	—	2,80	4,60	8,00	0,55	1,25	2,90	2,44	5,55	12,87	3,68	3,75	A	
	2,00	2,50	—	—	2,30	3,60	—	—	2,80	5,90	9,00	0,55	1,59	2,90	2,44	7,05	12,87	3,71	3,75	A	
	2,00	3,50	—	—	2,30	4,50	—	—	2,80	6,80	10,00	0,55	1,83	2,90	2,44	8,12	12,87	3,72	3,75	A	
	2,00	4,20	—	—	2,30	5,40	—	—	3,10	7,70	10,00	0,55	2,05	2,90	2,44	9,09	12,87	3,76	3,80	A	
	2,00	5,00	—	—	2,30	6,00	—	—	3,10	8,30	10,00	0,55	2,22	2,90	2,44	9,85	12,87	3,74	3,80	A	
	2,00	7,10	—	—	2,13	6,47	—	—	3,10	8,60	10,00	0,55	2,30	2,90	2,44	10,20	12,87	3,74	3,85	A	
	2,50	2,50	—	—	3,60	3,60	—	—	3,10	7,20	10,00	0,55	1,94	2,90	2,44	8,61	12,87	3,71	3,85	A	
	2,50	3,50	—	—	3,60	4,50	—	—	3,10	8,10	10,00	0,55	2,12	2,90	2,44	9,41	12,87	3,82	3,83	A	
	2,50	4,20	—	—	3,44	5,16	—	—	3,10	8,60	10,00	0,55	2,25	2,90	2,44	9,98	12,87	3,82	3,87	A	
	2,50	5,00	—	—	3,23	5,38	—	—	3,10	8,60	10,00	0,55	2,22	2,90	2,44	9,85	12,87	3,87	3,85	A	
	2,50	7,10	—	—	2,92	5,68	—	—	3,10	8,60	10,00	0,55	2,22	2,90	2,44	9,85	12,87	3,87	3,84	A	
	3,50	3,50	—	—	4,30	4,30	—	—	3,10	8,60	10,00	0,55	2,22	2,90	2,44	9,85	12,87	3,87	3,86	A	
	3,50	4,20	—	—	3,91	4,69	—	—	3,10	8,60	10,00	0,55	2,22	3,00	2,44	9,85	13,31	3,87	3,82	A	
	3,50	5,00	—	—	3,51	4,69	—	—	3,10	8,20	10,00	0,55	2,10	3,00	2,44	9,32	13,31	3,90	3,80	A	
	3,50	7,10	—	—	3,37	5,23	—	—	3,10	8,60	10,00	0,55	2,20	3,00	2,44	9,76	13,31	3,91	3,84	A	
	4,20	4,20	—	—	4,30	4,30	—	—	3,10	8,60	10,00	0,55	2,20	3,10	2,44	9,76	13,75	3,91	3,86	A	
	4,20	5,00	—	—	4,07	4,53	—	—	3,10	8,60	10,00	0,55	2,19	3,10	2,44	9,72	13,75	3,93	3,83	A	
	4,20	7,10	—	—	3,75	4,85	—	—	3,10	8,60	10,00	0,55	2,19	3,10	2,44	9,72	13,75	3,93	3,86	A	
	5,00	5,00	—	—	4,30	4,30	—	—	3,10	8,60	10,00	0,55	2,19	3,10	2,44	9,72	13,75	3,93	3,86	A	
	5,00	7,10	—	—	3,97	4,63	—	—	3,10	8,60	10,00	0,55	2,19	3,10	2,44	9,72	13,75	3,93	3,87	A	
3	2,00	2,00	2,00	—	2,30	2,30	2,30	—	3,10	6,90	9,50	0,55	1,85	3,10	2,44	8,21	13,75	3,73	3,80	A	
	2,00	2,00	2,50	—	2,30	2,30	3,60	—	3,10	8,20	10,00	0,55	2,16	3,10	2,44	9,58	13,75	3,80	3,80	A	
	2,00	2,00	3,50	—	2,17	2,17	4,25	—	3,10	8,60	10,00	0,55	2,26	3,10	2,44	10,03	13,75	3,81	3,80	A	
	2,00	2,00	4,20	—	1,98	1,98	4,64	—	3,10	8,60	10,00	0,55	2,25	3,10	2,44	9,98	13,75	3,82	3,80	A	
	2,00	2,00	5,00	—	1,87	1,87	4,87	—	3,10	8,60	10,00	0,55	2,25	3,10	2,44	9,98	13,75	3,82	3,80	A	
	2,00	2,00	7,10	—	1,71	1,71	5,19	—	3,10	8,60	10,00	0,55	2,25	3,10	2,44	9,98	13,75	3,82	3,80	A	
	2,00	2,50	2,50	—	2,08	3,26	3,26	—	3,10	8,60	10,00	0,55	2,25	3,10	2,44	9,98	13,75	3,82	3,80	A	
	2,00	2,50	3,50	—	1,90	2,98	3,72	—	3,10	8,60	10,00	0,55	2,25	3,10	2,44	9,98	13,75	3,82	3,80	A	
	2,00	2,50	4,20	—	1,75	2,74	4,11	—	3,10	8,60	10,00	0,55	2,25	3,10	2,44	9,98	13,75	3,82	3,80	A	
	2,00	2,50	5,00	—	1,66	2,60	4,34	—	3,10	8,60	10,00	0,55	2,25	3,10	2,44	9,98	13,75	3,82	3,82	A	
	2,00	2,50	7,10	—	1,53	2,40	4,67	—	3,10	8,60	10,00	0,55	2,25	3,10	2,44	9,98	13,75	3,82	3,82	A	
	2,00	3,50	3,50	—	1,75	3,42	3,42	—	3,10	8,60	10,00	0,55	2,23	3,10	2,44	9,89	13,75	3,86	3,82	A	
	2,00	3,50	4,20	—	1,62	3,17	3,81	—	3,10	8,60	10,00	0,55	2,23	3,10	2,44	9,89	13,75	3,86	3,82	A	
	2,00	3,50	5,00	—	1,55	3,02	4,03	—	3,10	8,60	10,00	0,55	2,23	3,10	2,44	9,89	13,75	3,86	3,82	A	
	2,00	3,50	7,10	—	1,43	2,80	4,36	—	3,10	8,60	10,00	0,55	2,23	3,10	2,44	9,89	13,75	3,86	3,82	A	
	2,00	4,20	4,20	—	1,51	3,55	3,55	—	3,10	8,60	10,00	0,55	2,23	3,10	2,44	9,89	13,75	3,86	3,82	A	
	2,00	4,20	5,00	—	1,44	3,39	3,77	—	3,10	8,60	10,00	0,55	2,23	3,10	2,44	9,89	13,75	3,86	3,82	A	
	2,00	4,20	7,10	—	1,35	3,16	4,10	—	3,10	8,60	10,00	0,55	2,23	3,10	2,44	9,89	13,75	3,86	3,87	A	
	2,50	2,50	2,50	—	2,87	2,87	2,87	—	3,10	8,60	10,00	0,55	2,23	3,10	2,44	9,89	13,75	3,86	3,87	A	
	2,50	2,50	3,50	—	2,65	2,65	3,31	—	3,10	8,60	10,00	0,55	2,23	3,10	2,44	9,89	13,75	3,86	3,87	A	
	2,50	2,50	4,20	—	2,46	2,46	3,69	—	3,10	8,60	10,00	0,55	2,23	3,10	2,44	9,89	13,75	3,86	3,87	A	
	2,50	2,50	5,00	—	2,35	2,35	3,91	—	3,10	8,60	10,00	0,55	2,23	3,10	2,44	9,89	13,75	3,86	3,87	A	
	2,50	2,50	7,10	—	2,18	2,18	4,24	—	3,10	8,60	10,00	0,55	2,23	3,10	2,44	9,89	13,75	3,86	3,90	A	
	2,50	3,50	3,50	—	2,46	3,07	3,07	—	3,10	8,60	10,00	0,55	2,19	3,10	2,44	9,72	13,75	3,93	3,85	A	
	2,50	3,50	4,20	—	2,29	2,87	3,44	—	3,10	8,60	10,00	0,55	2,19	3,10	2,44	9,72	13,75	3,93	3,85	A	
	2,50	3,50	5,00	—	2,20	2,74	3,66	—	3,10	8,60	10,00	0,55	2,19	3,10	2,44	9,72	13,75	3,93	3,85	A	
	2,50	3,50	7,10	—	2,05	2,56	3,99	—	3,10	8,60	10,00	0,55	2,18	3,10	2,44	9,67	13,75	3,94	3,85	A	
	2,50	4,20	4,20	—	2,15	3,23	3,23	—	3,10	8,60	10,00	0,55	2,18	3,10	2,44	9,67	13,75	3,94	3,85	A	
	2,50	4,20	5,00	—	2,06	3,10	3,44	—	3,10	8,60	10,00	0,55	2,18	3,10	2,44	9,67	13,75	3,94	3,85	A	
	3,50	3,50	3,50	—	2,87	2,87	2,87	—	3,10	8,60	10,00	0,55	2,18	3,10	2,44	9,67	13,75	3,94	3,90	A	
3,50	3,50	4,20	—	2,69	2,69	3,23	—	3,10	8,60	10,00	0,55	2,18	3,10	2,44	9,67	13,75	3,94	3,90	A		
3,50	3,50	5,00	—	2,58	2,58	3,44	—	3,10	8,60	10,00	0,55	2,18	3,10	2,44	9,67	13,75	3,94	3,90	A		
4	2,00	2,00	2,00	2,00	2,15	2,15	2,15	2,15	3,10	8,60	10,00	0,55	2,25	3,10	2,44	9,98	13,75	3,82	3,85	A	
	2,00	2,00	2,00	2,50	1,88	1,88	1,88	2,95	3,10	8,60	10,00	0,55	2,22	3,10	2,44	9,85	13,75	3,87	3,85	A	
	2,00	2,00	2,00	3,50	1,74	1,74	1,74	3,39	3,10	8,60	10,00	0,55	2,22	3,10	2,44	9,85	13,75	3,87	3,85	A	
	2,00	2,00	2,00	4,20	1,61	1,61	1,61	3,78	3,10	8,60	10,00	0,55	2,19	3,10	2,44	9,72	13,75	3,93	3,85	A	
	2,00	2,00	2,00	5,00	1,53	1,53	1,53	4,00	3,10	8,60	10,00	0,55	2,19	3,10	2,44	9,72	13,75	3,93	3,85	A	
	2,00	2,00	2,00	7,10	1,42	1,42	1,42	4,33	3,10	8,60	10,00	0,55	2,19	3,10	2,44	9,72	13,75	3,93	3,85	A	
	2,00	2,00	2,50	2,50	1,68	1,68	2,62	2,62	3,10	8,60	10,00	0,55	2,19	3,10	2,44	9,72	13,75	3,93	3,85	A	
	2,00	2,00	2,50	3,50	1,56	1,56	2,44	3,05	3,10	8,60	10,00	0,55	2,19	3,10	2,44	9,72	13,75	3,93	3,85	A	

MULTISPLIT COMBINATIONS TABLE

4U85S2SR5FA Inverter (The values in the table refer to the FLEXIS series)

COOLING																				
Combinations				Output power (kW)				System output power (kW)			Absorbed power (kW)			Absorbed current (A)			EER	SEER	Energy class	
UI	A	B	C	D	A	B	C	D	min		nom		max		min		nom		max	
									min	nom	max	min	nom	max	min	nom	max			
2	2.00	2.00	—	—	2.00	2.00	—	—	2.50	4.00	5.60	0.55	1.30	3.20	2.44	5.77	14.20	3.08	6.20	A++
	2.00	2.50	—	—	2.00	2.60	—	—	2.50	4.60	6.70	0.55	1.50	3.20	2.44	6.65	14.20	3.07	6.20	A++
	2.00	3.50	—	—	2.00	3.60	—	—	2.50	5.60	8.10	0.55	1.80	3.20	2.44	7.99	14.20	3.11	6.20	A++
	2.00	4.20	—	—	2.00	4.40	—	—	2.50	6.40	7.80	0.55	2.05	3.20	2.44	9.09	14.20	3.12	6.20	A++
	2.00	5.00	—	—	2.00	5.20	—	—	2.50	7.20	9.30	0.55	2.28	3.20	2.44	10.12	14.20	3.16	6.20	A++
	2.00	7.10	—	—	2.00	6.50	—	—	2.50	8.50	9.30	0.55	2.65	3.30	2.44	11.76	14.64	3.21	6.20	A++
	2.50	2.50	—	—	2.60	2.60	—	—	2.50	5.20	7.80	0.55	1.60	3.30	2.44	7.10	14.64	3.25	6.20	A++
	2.50	3.50	—	—	2.60	3.60	—	—	2.50	6.20	9.10	0.55	1.98	3.30	2.44	8.78	14.64	3.13	6.20	A++
	2.50	4.20	—	—	2.60	4.40	—	—	2.50	7.00	9.30	0.55	2.20	3.30	2.44	9.76	14.64	3.18	6.20	A++
	2.50	5.00	—	—	2.60	5.20	—	—	2.50	7.80	9.30	0.55	2.35	3.30	2.44	10.43	14.64	3.32	6.20	A++
	2.50	7.10	—	—	2.43	6.07	—	—	2.50	8.50	9.30	0.55	2.60	3.30	2.44	11.54	14.64	3.27	6.20	A++
	3.50	3.50	—	—	3.60	3.60	—	—	2.50	7.20	9.30	0.55	2.20	3.30	2.44	9.76	14.64	3.27	6.20	A++
	3.50	4.20	—	—	3.60	4.40	—	—	2.50	8.00	9.30	0.55	2.42	3.30	2.44	10.74	14.64	3.31	6.20	A++
	3.50	5.00	—	—	3.51	4.79	—	—	2.50	8.10	9.50	0.55	2.52	3.30	2.44	11.18	14.64	3.21	6.20	A++
	3.50	7.10	—	—	3.03	5.47	—	—	2.50	8.50	9.50	0.55	2.59	3.30	2.44	11.49	14.64	3.28	6.20	A++
	4.20	4.20	—	—	4.25	4.25	—	—	2.50	8.50	9.50	0.55	2.59	3.30	2.44	11.49	14.64	3.28	6.20	A++
	4.20	5.00	—	—	3.90	4.60	—	—	2.50	8.50	9.50	0.55	2.59	3.30	2.44	11.49	14.64	3.28	6.20	A++
	4.20	7.10	—	—	3.43	5.07	—	—	2.50	8.50	9.50	0.55	2.58	3.30	2.44	11.45	14.64	3.29	6.20	A++
	5.00	5.00	—	—	4.25	4.25	—	—	2.50	8.50	9.50	0.55	2.56	3.30	2.44	11.36	14.64	3.32	6.20	A++
	5.00	7.10	—	—	3.78	4.72	—	—	2.50	8.50	9.50	0.55	2.55	3.30	2.44	11.31	14.64	3.33	6.20	A++
	7.10	7.10	—	—	4.25	4.25	—	—	2.50	8.50	9.50	0.55	2.55	3.30	2.44	11.31	14.64	3.33	6.20	A++
3	2.00	2.00	2.00	—	2.00	2.00	2.00	—	3.00	6.00	9.50	0.55	1.85	3.50	2.44	8.21	15.53	3.24	6.70	A++
	2.00	2.00	2.50	—	2.00	2.00	2.60	—	3.00	6.60	9.50	0.55	2.00	3.50	2.44	8.87	15.53	3.30	6.70	A++
	2.00	2.00	3.50	—	2.00	2.00	3.60	—	3.00	7.60	9.50	0.55	2.30	3.50	2.44	10.20	15.53	3.30	6.70	A++
	2.00	2.00	4.20	—	2.00	2.00	4.40	—	3.20	8.40	9.50	0.55	2.56	3.50	2.44	11.36	15.53	3.28	6.70	A++
	2.00	2.00	5.00	—	1.85	1.85	4.80	—	3.20	8.50	9.50	0.55	2.57	3.50	2.44	11.40	15.53	3.31	6.70	A++
	2.00	2.00	7.10	—	1.62	1.62	5.26	—	3.20	8.50	9.50	0.55	2.57	3.50	2.44	11.40	15.53	3.31	6.70	A++
	2.00	2.50	2.50	—	2.00	2.60	2.60	—	3.20	7.20	9.50	0.55	2.20	3.50	2.44	9.76	15.53	3.27	6.70	A++
	2.00	2.50	3.50	—	2.00	2.60	3.60	—	3.20	8.20	9.50	0.55	2.50	3.50	2.44	11.09	15.53	3.28	6.70	A++
	2.00	2.50	4.20	—	1.89	2.46	4.16	—	3.20	8.50	9.50	0.55	2.56	3.50	2.44	11.36	15.53	3.32	6.70	A++
	2.00	2.50	5.00	—	1.73	2.26	4.51	—	3.20	8.50	9.50	0.55	2.56	3.50	2.44	11.36	15.53	3.32	6.70	A++
	2.00	2.50	7.10	—	1.53	1.99	4.98	—	3.20	8.50	9.50	0.55	2.56	3.50	2.44	11.36	15.53	3.32	6.70	A++
	2.00	3.50	3.50	—	1.85	3.33	3.33	—	3.20	8.50	9.50	0.55	2.56	3.50	2.44	11.36	15.53	3.32	6.70	A++
	2.00	3.50	4.20	—	1.70	3.06	3.74	—	3.20	8.50	9.50	0.55	2.56	3.50	2.44	11.36	15.53	3.32	6.70	A++
	2.00	3.50	5.00	—	1.57	2.83	4.09	—	3.20	8.50	9.50	0.55	2.56	3.50	2.44	11.36	15.53	3.32	6.70	A++
	2.00	3.50	7.10	—	1.40	2.53	4.57	—	3.20	8.50	9.50	0.55	2.56	3.50	2.44	11.36	15.53	3.32	6.70	A++
	2.00	4.20	4.20	—	1.57	3.46	3.46	—	3.20	8.50	9.50	0.55	2.56	3.50	2.44	11.36	15.53	3.32	6.70	A++
	2.00	4.20	5.00	—	1.47	3.22	3.81	—	3.20	8.50	9.50	0.55	2.56	3.50	2.44	11.36	15.53	3.32	6.70	A++
	2.00	4.20	7.10	—	1.32	2.90	4.28	—	3.20	8.50	9.50	0.55	2.56	3.50	2.44	11.36	15.53	3.32	6.70	A++
	2.00	5.00	5.00	—	1.37	3.56	3.56	—	3.20	8.50	9.50	0.55	2.56	3.50	2.44	11.36	15.53	3.32	6.70	A++
	2.50	2.50	2.50	—	2.60	2.60	2.60	—	3.20	7.80	9.50	0.55	2.35	3.50	2.44	10.43	15.53	3.32	6.72	A++
	2.50	2.50	3.50	—	2.51	2.51	3.48	—	3.20	8.50	9.50	0.55	2.55	3.50	2.44	11.31	15.53	3.33	6.72	A++
	2.50	2.50	4.20	—	2.30	2.30	3.90	—	3.20	8.50	9.50	0.55	2.55	3.50	2.44	11.31	15.53	3.33	6.74	A++
	2.50	2.50	5.00	—	2.13	2.13	4.25	—	3.20	8.50	9.50	0.55	2.55	3.50	2.44	11.31	15.53	3.33	6.74	A++
	2.50	2.50	7.10	—	1.89	1.89	4.72	—	3.20	8.50	9.50	0.55	2.55	3.50	2.44	11.31	15.53	3.33	6.70	A++
	2.50	3.50	3.50	—	2.26	3.12	3.12	—	3.20	8.50	9.50	0.55	2.55	3.50	2.44	11.31	15.53	3.33	6.73	A++
	2.50	3.50	4.20	—	2.08	2.89	3.53	—	3.20	8.50	9.50	0.55	2.55	3.50	2.44	11.31	15.53	3.33	6.70	A++
	2.50	3.50	5.00	—	1.94	2.68	3.88	—	3.20	8.50	9.50	0.55	2.55	3.50	2.44	11.31	15.53	3.33	6.70	A++
	2.50	3.50	7.10	—	1.74	2.41	4.35	—	3.20	8.50	9.50	0.55	2.55	3.50	2.44	11.31	15.53	3.33	6.70	A++
	2.50	4.20	4.20	—	1.94	3.28	3.28	—	3.20	8.50	9.50	0.55	2.55	3.50	2.44	11.31	15.53	3.33	6.70	A++
	2.50	4.20	5.00	—	1.81	3.07	3.62	—	3.20	8.50	9.50	0.55	2.55	3.50	2.44	11.31	15.53	3.33	6.70	A++
	2.50	4.20	7.10	—	1.64	2.77	4.09	—	3.20	8.50	9.50	0.55	2.55	3.50	2.44	11.31	15.53	3.33	6.70	A++
	2.50	5.00	5.00	—	1.70	3.40	3.40	—	3.20	8.50	9.50	0.55	2.55	3.50	2.44	11.31	15.53	3.33	6.70	A++
	3.50	3.50	3.50	—	2.83	2.83	2.83	—	3.20	8.50	9.50	0.55	2.53	3.50	2.44	11.22	15.53	3.36	6.75	A++
	3.50	3.50	4.20	—	2.64	2.64	3.22	—	3.20	8.50	9.50	0.55	2.53	3.50	2.44	11.22	15.53	3.36	6.70	A++
	3.50	3.50	5.00	—	2.47	2.47	3.56	—	3.20	8.50	9.50	0.55	2.53	3.50	2.44	11.22	15.53	3.36	6.70	A++
	3.50	3.50	7.10	—	2.23	2.23	4.03	—	3.20	8.50	9.50	0.55	2.53	3.50	2.44	11.22	15.53	3.36	6.70	A++
	3.50	4.20	4.20	—	2.47	3.02	3.02	—	3.20	8.50	9.50	0.55	2.53	3.50	2.44	11.22	15.53	3.36	6.75	A++
	3.50	4.20	5.00	—	2.32	2.83	3.35	—	3.20	8.50	9.50	0.55	2.53	3.50	2.44	11.22	15.53	3.36	6.75	A++
	3.50	5.00	5.00	—	2.19	3.16	3.16	—	3.20	8.50	9.50	0.55	2.53	3.50	2.44	11.22	15.53	3.36	6.75	A++
	4.20	4.20	4.20	—	2.83	2.83	2.83	—	3.20	8.50	9.50	0.55	2.53	3.50	2.44	11.22	15.53	3.36	6.75	A++
	4.20	4.20	5.00	—	2.67	2.67	3.16	—	3.20	8.50	9.50	0.55	2.53	3.50	2.44	11.22	15.53	3.36	6.75	A++
	2.00	2.00	2.00	2.00	2.00	2.00	2.00	2.00	3.20	8.00	9.50	0.55	2.43	3.50	2.44	10.78	15.53	3.29	6.80	A++
	2.00	2.00	2.00	2.50	1.98	1.98	1.98	2.57	3.20	8.50	9.50	0.55	2.55	3.50	2.44	11.31	15.53	3.33	6.80	A++
	2.00	2.00	2.00	3.50	1.77	1.77	1.77	3.19	3.20	8.50	9.50	0.55	2.54	3.50	2.44	11.27	15.53	3.35	6.80	A++
	2.00	2.00	2.00	4.20	1.63	1.63	1.63	3.60	3.20	8.50	9.50	0.55	2.54	3.50	2.44	11.27	15.53	3.35	6.80	A++
	2.00	2.00	2.00	5.00	1.52	1.52	1.52	3.95	3.20	8.50	9.50	0.55	2.54	3.50	2.44	11.27	15.53	3.35	6.80	A++
	2.00</																			

MULTISPLIT COMBINATIONS TABLE

4U85S2SR5FA Inverter (The values in the table refer to the FLEXIS series)

HEATING																					
UI	Combinations				Output power (kW)				System output power (kW)			Absorbed power (kW)			Absorbed current (A)			COP	SCOP	Energy class	
	A	B	C	D	A	B	C	D	min	nom	max	min	nom	max	min	nom	max				
2	2.00	2.00	—	—	2.30	2.30	—	—	2.80	4.60	8.00	0.55	1.25	3.30	2.44	5.55	14.64	3.68	3.75	A	
	2.00	2.50	—	—	2.30	3.60	—	—	3.00	5.90	10.00	0.55	1.59	3.30	2.44	7.05	14.64	3.71	3.75	A	
	2.00	3.50	—	—	2.30	4.50	—	—	3.20	6.80	10.00	0.55	1.83	3.30	2.44	8.12	14.64	3.72	3.75	A	
	2.00	4.20	—	—	2.30	5.40	—	—	3.40	7.70	10.00	0.55	2.05	3.30	2.44	9.09	14.64	3.76	3.80	A	
	2.00	5.00	—	—	2.30	6.00	—	—	3.80	8.30	10.50	0.55	2.22	3.30	2.44	9.85	14.64	3.74	3.80	A	
	2.00	7.10	—	—	2.30	7.00	—	—	4.00	9.30	10.50	0.55	2.50	3.30	2.44	11.09	14.64	3.72	3.85	A	
	2.50	2.50	—	—	3.60	3.60	—	—	3.40	7.20	10.50	0.55	1.94	3.30	2.44	8.61	14.64	3.71	3.85	A	
	2.50	3.50	—	—	3.60	4.50	—	—	3.80	8.10	10.50	0.55	2.10	3.30	2.44	9.32	14.64	3.86	3.85	A	
	2.50	4.20	—	—	3.60	5.40	—	—	4.00	9.00	10.50	0.55	2.30	3.30	2.44	10.20	14.64	3.91	3.87	A	
	2.50	5.00	—	—	3.60	6.00	—	—	4.40	9.60	10.50	0.55	2.50	3.30	2.44	11.09	14.64	3.84	3.85	A	
	2.50	7.10	—	—	3.26	6.34	—	—	4.40	9.60	10.50	0.55	2.55	3.30	2.44	11.31	14.64	3.76	3.84	A	
	3.50	3.50	—	—	4.50	4.50	—	—	4.00	9.00	10.50	0.55	2.35	3.30	2.44	10.43	14.64	3.83	3.86	A	
	3.50	4.20	—	—	4.36	5.24	—	—	4.40	9.60	10.50	0.55	2.50	3.30	2.44	11.09	14.64	3.84	3.82	A	
	3.50	5.00	—	—	3.86	5.14	—	—	4.40	9.00	10.50	0.55	2.37	3.30	2.44	10.51	14.64	3.80	3.80	A	
	3.50	7.10	—	—	3.76	5.84	—	—	4.40	9.60	10.50	0.55	2.50	3.30	2.44	11.09	14.64	3.84	3.84	A	
	4.20	4.20	—	—	4.80	4.80	—	—	4.40	9.60	10.50	0.55	2.49	3.30	2.44	11.05	14.64	3.86	3.86	A	
	4.20	5.00	—	—	4.55	5.05	—	—	4.40	9.60	10.50	0.55	2.49	3.30	2.44	11.05	14.64	3.86	3.83	A	
	4.20	7.10	—	—	4.18	5.42	—	—	4.40	9.60	10.50	0.55	2.48	3.30	2.44	11.00	14.64	3.87	3.86	A	
	5.00	5.00	—	—	4.80	4.80	—	—	4.40	9.60	10.50	0.55	2.46	3.30	2.44	10.91	14.64	3.90	3.86	A	
	5.00	7.10	—	—	4.43	5.17	—	—	4.40	9.60	10.50	0.55	2.48	3.30	2.44	11.00	14.64	3.87	3.87	A	
7.10	7.10	—	—	4.80	4.80	—	—	4.40	9.60	10.50	0.55	2.50	3.30	2.44	11.09	14.64	3.84	3.85	A		
3	2.00	2.00	2.00	—	2.30	2.30	2.30	—	3.80	6.90	10.50	0.55	1.85	3.40	2.44	8.21	15.08	3.73	3.80	A	
	2.00	2.00	2.50	—	2.30	2.30	3.60	—	4.00	8.20	10.50	0.55	2.16	3.40	2.44	9.58	15.08	3.80	3.80	A	
	2.00	2.00	3.50	—	2.30	2.30	4.50	—	4.20	9.10	10.50	0.55	2.39	3.40	2.44	10.60	15.08	3.81	3.80	A	
	2.00	2.00	4.20	—	2.21	2.21	5.18	—	4.40	9.60	10.50	0.55	2.48	3.40	2.44	11.00	15.08	3.87	3.80	A	
	2.00	2.00	5.00	—	2.08	2.08	5.43	—	4.40	9.60	10.50	0.55	2.48	3.40	2.44	11.00	15.08	3.87	3.80	A	
	2.00	2.00	7.10	—	1.90	1.90	5.79	—	4.40	9.60	10.50	0.55	2.50	3.40	2.44	11.09	15.08	3.84	3.80	A	
	2.00	2.50	2.50	—	2.32	3.64	3.64	—	4.40	9.60	10.50	0.55	2.54	3.40	2.44	11.27	15.08	3.78	3.80	A	
	2.00	2.50	3.50	—	2.12	3.32	4.15	—	4.40	9.60	10.50	0.55	2.48	3.40	2.44	11.00	15.08	3.87	3.80	A	
	2.00	2.50	4.20	—	1.95	3.06	4.59	—	4.40	9.60	10.50	0.55	2.48	3.40	2.44	11.00	15.08	3.87	3.80	A	
	2.00	2.50	5.00	—	1.86	2.90	4.84	—	4.40	9.60	10.50	0.55	2.47	3.40	2.44	10.96	15.08	3.89	3.82	A	
	2.00	2.50	7.10	—	1.71	2.68	5.21	—	4.40	9.60	10.50	0.55	2.50	3.40	2.44	11.09	15.08	3.84	3.82	A	
	2.00	3.50	3.50	—	1.95	3.82	3.82	—	4.40	9.60	10.50	0.55	2.52	3.40	2.44	11.18	15.08	3.81	3.82	A	
	2.00	3.50	4.20	—	1.81	3.54	4.25	—	4.40	9.60	10.50	0.55	2.46	3.40	2.44	10.91	15.08	3.90	3.82	A	
	2.00	3.50	5.00	—	1.73	3.38	4.50	—	4.40	9.60	10.50	0.55	2.46	3.40	2.44	10.91	15.08	3.90	3.82	A	
	2.00	3.50	7.10	—	1.60	3.13	4.87	—	4.40	9.60	10.50	0.55	2.46	3.40	2.44	10.91	15.08	3.90	3.82	A	
	2.00	4.20	4.20	—	1.69	3.96	3.96	—	4.40	9.60	10.50	0.55	2.46	3.40	2.44	10.91	15.08	3.90	3.82	A	
	2.00	4.20	5.00	—	1.61	3.78	4.20	—	4.40	9.60	10.50	0.55	2.46	3.40	2.44	10.91	15.08	3.90	3.82	A	
	2.00	4.20	7.10	—	1.50	3.53	4.57	—	4.40	9.60	10.50	0.55	2.46	3.40	2.44	10.91	15.08	3.90	3.87	A	
	2.00	5.00	5.00	—	1.54	4.03	4.03	—	4.40	9.60	10.50	0.55	2.46	3.40	2.44	10.91	15.08	3.90	3.87	A	
	2.50	2.50	2.50	—	3.20	3.20	3.20	—	4.40	9.60	10.50	0.55	2.45	3.40	2.44	10.87	15.08	3.92	3.87	A	
	2.50	2.50	3.50	—	2.95	2.95	3.69	—	4.40	9.60	10.50	0.55	2.45	3.40	2.44	10.87	15.08	3.92	3.87	A	
	2.50	2.50	4.20	—	2.74	2.74	4.11	—	4.40	9.60	10.50	0.55	2.45	3.40	2.44	10.87	15.08	3.92	3.87	A	
	2.50	2.50	5.00	—	2.62	2.62	4.36	—	4.40	9.60	10.50	0.55	2.45	3.40	2.44	10.87	15.08	3.92	3.87	A	
	2.50	2.50	7.10	—	2.43	2.43	4.73	—	4.40	9.60	10.50	0.55	2.45	3.40	2.44	10.87	15.08	3.92	3.90	A	
	2.50	3.50	3.50	—	2.74	3.43	3.43	—	4.40	9.60	10.50	0.55	2.45	3.40	2.44	10.87	15.08	3.92	3.85	A	
	2.50	3.50	4.20	—	2.56	3.20	3.84	—	4.40	9.60	10.50	0.55	2.45	3.40	2.44	10.87	15.08	3.92	3.85	A	
	2.50	3.50	5.00	—	2.45	3.06	4.09	—	4.40	9.60	10.50	0.55	2.45	3.40	2.44	10.87	15.08	3.92	3.85	A	
	2.50	3.50	7.10	—	2.29	2.86	4.45	—	4.40	9.60	10.50	0.55	2.45	3.40	2.44	10.87	15.08	3.92	3.85	A	
	2.50	4.20	4.20	—	2.40	3.60	3.60	—	4.40	9.60	10.50	0.55	2.45	3.40	2.44	10.87	15.08	3.92	3.85	A	
	2.50	4.20	5.00	—	2.30	3.46	3.84	—	4.40	9.60	10.50	0.55	2.45	3.40	2.44	10.87	15.08	3.92	3.85	A	
	2.50	4.20	7.10	—	2.16	3.24	4.20	—	4.40	9.60	10.50	0.55	2.45	3.40	2.44	10.87	15.08	3.92	3.85	A	
	2.50	5.00	5.00	—	2.22	3.69	3.69	—	4.40	9.60	10.50	0.55	2.45	3.40	2.44	10.87	15.08	3.92	3.85	A	
	3.50	3.50	3.50	—	3.20	3.20	3.20	—	4.40	9.60	10.50	0.55	2.45	3.40	2.44	10.87	15.08	3.92	3.90	A	
	3.50	3.50	4.20	—	3.00	3.00	3.60	—	4.40	9.60	10.50	0.55	2.45	3.40	2.44	10.87	15.08	3.92	3.90	A	
	3.50	3.50	5.00	—	2.88	2.88	3.84	—	4.40	9.60	10.50	0.55	2.43	3.40	2.44	10.78	15.08	3.95	3.90	A	
	3.50	3.50	7.10	—	2.70	2.70	4.20	—	4.40	9.60	10.50	0.55	2.43	3.40	2.44	10.78	15.08	3.95	3.85	A	
	3.50	4.20	4.20	—	2.82	3.39	3.39	—	4.40	9.60	10.50	0.55	2.43	3.40	2.44	10.78	15.08	3.95	3.90	A	
	3.50	4.20	5.00	—	2.72	3.26	3.62	—	4.40	9.60	10.50	0.55	2.43	3.40	2.44	10.78	15.08	3.95	3.90	A	
	3.50	5.00	5.00	—	2.62	3.49	3.49	—	4.40	9.60	10.50	0.55	2.43	3.40	2.44	10.78	15.08	3.95	3.90	A	
	4.20	4.20	4.20	—	3.20	3.20	3.20	—	4.40	9.60	10.50	0.55	2.43	3.40	2.44	10.78	15.08	3.95	3.90	A	
4.20	4.20	5.00	—	3.09	3.09	3.43	—	4.40	9.60	10.50	0.55	2.43	3.40	2.44	10.78	15.08	3.95	3.90	A		
4	2.00	2.00	2.00	2.00	2.30	2.30	2.30	2.30	4.20	9.20	10.50	0.55	2.42	3.40	2.44	10.74	15.08	3.80	3.85	A	
	2.00	2.00	2.00	2.50	2.10	2.10	2.10	3.29	4.20	9.60	10.50	0.55	2.44	3.40	2.44	10.83	15.08	3.93	3.85	A	
	2.00	2.00	2.00	3.50	1.94	1.94	1.94	3.79	4.40	9.60	10.50	0.55	2.44	3.40	2.44	10.83	15.08	3.93	3.85	A	
	2.00	2.00	2.00	4.20	1.80	1.80	1.80	4.21	4.40	9.60	10.50	0.55	2.44	3.40	2.44	10.83	15.08	3.93	3.85	A	
	2.00	2.00	2.00	5.00	1.71	1.71	1.71	4.47	4.40	9.60	10.50	0.55	2.44	3.40	2.44	10.83	15.08	3.93	3.85	A	
	2.00	2.00	2.00	7.10	1.59	1.59															

MULTISPLIT COMBINATIONS TABLE

5U90S2SS5FA Inverter (The values in the table refer to the FLEXIS series)

COOLING																						
Combinations					Output power (kW)					System output power (kW)			Absorbed power (kW)			Absorbed current (A)			EER	SEER	Energy class	
UI	A	B	C	D	E	A	B	C	D	E	min	nom	max	min	nom	max	min	nom	max			
2	2.00	2.00	—	—	—	2.00	2.00	—	—	—	2.50	4.00	5.60	0.55	1.50	3.60	2.44	6.65	15.97	—	—	—
	2.00	2.50	—	—	—	2.00	2.60	—	—	—	2.50	4.60	6.70	0.55	1.67	3.60	2.44	7.41	15.97	2.75	6.20	A++
	2.00	3.50	—	—	—	2.00	3.60	—	—	—	2.50	5.60	8.10	0.55	2.03	3.60	2.44	9.01	15.97	2.76	6.20	A++
	2.00	4.20	—	—	—	2.00	4.40	—	—	—	2.50	6.40	7.80	0.55	2.30	3.60	2.44	10.20	15.97	2.78	6.20	A++
	2.00	5.00	—	—	—	2.00	5.20	—	—	—	2.50	7.20	9.30	0.55	2.58	3.60	2.44	11.45	15.97	2.79	6.20	A++
	2.00	7.10	—	—	—	2.00	6.50	—	—	—	2.50	8.50	9.30	0.55	2.95	3.60	2.44	13.09	15.97	2.88	6.20	A++
	2.50	2.50	—	—	—	2.60	2.60	—	—	—	2.50	5.20	7.80	0.55	1.89	3.60	2.44	8.39	15.97	2.75	6.20	A++
	2.50	3.50	—	—	—	2.60	3.60	—	—	—	2.50	6.20	9.10	0.55	2.23	3.60	2.44	9.89	15.97	2.78	6.20	A++
	2.50	4.20	—	—	—	2.60	4.40	—	—	—	2.50	7.00	9.30	0.55	2.51	3.60	2.44	11.14	15.97	2.79	6.20	A++
	2.50	5.00	—	—	—	2.60	5.20	—	—	—	2.50	7.80	9.30	0.55	2.79	3.60	2.44	12.38	15.97	2.80	6.20	A++
	2.50	7.10	—	—	—	2.57	6.43	—	—	—	2.50	9.00	9.30	0.55	2.99	3.60	2.44	13.27	15.97	3.01	6.20	A++
	3.50	3.50	—	—	—	3.60	3.60	—	—	—	2.50	7.20	9.30	0.55	2.41	3.60	2.44	10.69	15.97	2.99	6.20	A++
	3.50	4.20	—	—	—	3.60	4.40	—	—	—	2.50	8.00	9.30	0.55	2.68	3.60	2.44	11.89	15.97	2.99	6.20	A++
	3.50	5.00	—	—	—	3.60	5.20	—	—	—	2.50	8.80	10.00	0.55	2.91	3.60	2.44	12.91	15.97	3.02	6.20	A++
	3.50	7.10	—	—	—	3.21	5.79	—	—	—	2.50	9.00	11.00	0.55	3.02	3.60	2.44	13.40	15.97	2.98	6.20	A++
	4.20	4.20	—	—	—	4.40	4.40	—	—	—	2.50	8.80	10.00	0.55	2.83	3.60	2.44	12.56	15.97	3.11	6.20	A++
	4.20	5.00	—	—	—	4.13	4.88	—	—	—	2.50	9.00	10.50	0.55	2.89	3.60	2.44	12.82	15.97	3.11	6.20	A++
	4.20	7.10	—	—	—	3.63	5.37	—	—	—	2.50	9.00	11.00	0.55	2.96	3.60	2.44	13.13	15.97	3.04	6.20	A++
5.00	5.00	—	—	—	4.50	4.50	—	—	—	2.50	9.00	11.00	0.55	3.01	3.60	2.44	13.35	15.97	2.99	6.20	A++	
5.00	7.10	—	—	—	4.00	5.00	—	—	—	2.50	9.00	11.00	0.55	3.15	3.60	2.44	13.98	15.97	2.86	6.20	A++	
7.10	7.10	—	—	—	4.50	4.50	—	—	—	2.50	9.00	11.00	0.55	3.15	3.60	2.44	13.98	15.97	2.86	6.20	A++	
3	2.00	2.00	2.00	—	—	2.00	2.00	2.00	—	—	3.00	6.00	9.50	0.55	2.05	3.80	2.44	9.09	16.86	2.93	6.70	A++
	2.00	2.00	2.50	—	—	2.00	2.00	2.60	—	—	3.00	6.60	9.50	0.55	2.21	3.80	2.44	9.80	16.86	2.99	6.70	A++
	2.00	2.00	3.50	—	—	2.00	2.00	3.60	—	—	3.00	7.60	9.50	0.55	2.38	3.80	2.44	10.56	16.86	3.19	6.70	A++
	2.00	2.00	4.20	—	—	2.00	2.00	4.40	—	—	3.20	8.40	9.50	0.55	2.67	3.80	2.44	11.85	16.86	3.15	6.70	A++
	2.00	2.00	5.00	—	—	1.96	1.96	5.09	—	—	3.20	9.00	10.00	0.55	2.84	3.80	2.44	12.60	16.86	3.17	6.70	A++
	2.00	2.00	7.10	—	—	1.71	1.71	5.57	—	—	3.20	9.00	11.00	0.55	2.98	4.10	2.44	13.22	18.19	3.02	6.70	A++
	2.00	2.50	2.50	—	—	2.00	2.60	2.60	—	—	3.20	7.20	9.50	0.55	2.33	3.80	2.44	10.34	16.86	3.09	6.70	A++
	2.00	2.50	3.50	—	—	2.00	2.60	3.60	—	—	3.20	8.20	9.50	0.55	2.57	3.80	2.44	11.40	16.86	3.19	6.70	A++
	2.00	2.50	4.20	—	—	2.00	2.60	4.40	—	—	3.20	9.00	10.00	0.55	2.82	3.80	2.44	12.51	16.86	3.19	6.70	A++
	2.00	2.50	5.00	—	—	1.84	2.39	4.78	—	—	3.20	9.00	11.00	0.55	2.88	3.80	2.44	12.78	16.86	3.13	6.70	A++
	2.00	2.50	7.10	—	—	1.62	2.11	5.27	—	—	3.20	9.00	11.00	0.55	3.03	4.10	2.44	13.44	18.19	2.97	6.70	A++
	2.00	3.50	3.50	—	—	1.96	3.52	3.52	—	—	3.20	9.00	11.00	0.55	2.86	3.80	2.44	12.69	16.86	3.15	6.70	A++
	2.00	3.50	4.20	—	—	1.80	3.24	3.96	—	—	3.20	9.00	11.00	0.55	2.93	4.10	2.44	13.00	18.19	3.07	6.70	A++
	2.00	3.50	5.00	—	—	1.67	3.00	4.33	—	—	3.20	9.00	11.00	0.55	2.99	4.10	2.44	13.27	18.19	3.01	6.70	A++
	2.00	3.50	7.10	—	—	1.49	2.68	4.83	—	—	3.20	9.00	11.00	0.55	3.00	4.10	2.44	13.31	18.19	3.00	6.70	A++
	2.00	4.20	4.20	—	—	1.67	3.67	3.67	—	—	3.20	9.00	11.00	0.55	2.97	4.10	2.44	13.18	18.19	3.03	6.70	A++
	2.00	4.20	5.00	—	—	1.55	3.41	4.03	—	—	3.20	9.00	11.00	0.55	2.97	4.10	2.44	13.18	18.19	3.03	6.70	A++
	2.00	4.20	7.10	—	—	1.40	3.07	4.53	—	—	3.20	9.00	11.00	0.55	3.00	4.10	2.44	13.31	18.19	3.00	6.70	A++
	2.00	5.00	5.00	—	—	1.45	3.77	3.77	—	—	3.20	9.00	11.00	0.55	2.98	4.10	2.44	13.22	18.19	3.02	6.70	A++
	2.50	2.50	2.50	—	—	2.60	2.60	2.60	—	—	3.20	7.80	9.50	0.55	2.56	3.80	2.44	11.36	16.86	3.05	6.72	A++
	2.50	2.50	3.50	—	—	2.60	2.60	3.60	—	—	3.20	8.80	10.00	0.55	2.75	3.80	2.44	12.20	16.86	3.20	6.72	A++
	2.50	2.50	4.20	—	—	2.44	2.44	4.13	—	—	3.20	9.00	11.00	0.55	2.87	3.80	2.44	12.73	16.86	3.14	6.74	A++
	2.50	2.50	5.00	—	—	2.25	2.25	4.50	—	—	3.20	9.00	11.00	0.55	2.97	4.10	2.44	13.18	18.19	3.03	6.74	A++
	2.50	2.50	7.10	—	—	2.00	2.00	5.00	—	—	3.20	9.00	11.00	0.55	2.97	4.10	2.44	13.18	18.19	3.03	6.70	A++
	2.50	3.50	3.50	—	—	2.39	3.31	3.31	—	—	3.20	9.00	11.00	0.55	2.92	3.80	2.44	12.95	16.86	3.08	6.73	A++
	2.50	3.50	4.20	—	—	2.21	3.06	3.74	—	—	3.20	9.00	11.00	0.55	2.97	4.10	2.44	13.18	18.19	3.03	6.70	A++
	2.50	3.50	5.00	—	—	2.05	2.84	4.11	—	—	3.20	9.00	11.00	0.55	2.97	4.10	2.44	13.18	18.19	3.03	6.70	A++
	2.50	3.50	7.10	—	—	1.84	2.55	4.61	—	—	3.20	9.00	11.00	0.55	2.97	4.10	2.44	13.18	18.19	3.03	6.70	A++
	2.50	4.20	4.20	—	—	2.05	3.47	3.47	—	—	3.20	9.00	11.00	0.55	2.97	4.10	2.44	13.18	18.19	3.03	6.70	A++
	2.50	4.20	5.00	—	—	1.92	3.25	3.84	—	—	3.20	9.00	11.00	0.55	2.97	4.10	2.44	13.18	18.19	3.03	6.70	A++
	2.50	4.20	7.10	—	—	1.73	2.93	4.33	—	—	3.20	9.00	11.00	0.55	3.00	4.10	2.44	13.31	18.19	3.00	6.70	A++
	2.50	5.00	5.00	—	—	1.80	3.60	3.60	—	—	3.20	9.00	11.00	0.55	3.00	4.10	2.44	13.31	18.19	3.00	6.70	A++
	3.50	3.50	3.50	—	—	3.00	3.00	3.00	—	—	3.20	9.00	11.00	0.55	2.96	4.10	2.44	13.13	18.19	3.04	6.75	A++
	3.50	3.50	4.20	—	—	2.79	2.79	3.41	—	—	3.20	9.00	11.00	0.55	2.95	4.10	2.44	13.09	18.19	3.05	6.70	A++
	3.50	3.50	5.00	—	—	2.61	2.61	3.77	—	—	3.20	9.00	11.00	0.55	2.96	4.10	2.44	13.13	18.19	3.04	6.70	A++
	3.50	3.50	7.10	—	—	2.36	2.36	4.27	—	—	3.20	9.00	11.00	0.55	2.96	4.10	2.44	13.13	18.19	3.04	6.70	A++
3.50	4.20	4.20	—	—	2.61	3.19	3.19	—	—	3.20	9.00	11.00	0.55	2.96	4.10	2.44	13.13	18.19	3.04	6.75	A++	
3.50	4.20	5.00	—	—	2.45	3.00	3.55	—	—	3.20	9.00	11.00	0.55	2.94	4.10	2.44	13.04	18.19	3.06	6.75	A++	
3.50	5.00	5.00	—	—	2.31	3.34	3.34	—	—	3.20	9.00	11.00	0.55	3.00	4.10	2.44	13.31	18.19	3.00	6.75	A++	
4.20	4.20	4.20	—	—	3.00	3.00	3.00	—	—	3.20	9.00	11.00	0.55	3.00	4.10	2.44	13.31	18.19	3.00	6.75	A++	
4.20	4.20	5.00	—	—	2.83	2.83	3.34	—	—	3.20	9.00	11.00	0.55	3.00	4.10	2.44	13.31	18.19	3.00	6.75	A++	

MULTISPLIT COMBINATIONS TABLE

5U90S2SS5FA Inverter (The values in the table refer to the FLEXIS series)

COOLING																						
Combinations					Output power (kW)					System output power (kW)			Absorbed power (kW)			Absorbed current (A)			EER	SEER	Energy class	
UI	A	B	C	D	E	A	B	C	D	E	min	nom	max	min	nom	max	min	nom	max			
4	2.00	2.00	2.00	2.00	—	2.00	2.00	2.00	2.00	—	3.20	8.00	11.00	0.55	2.66	4.00	2.44	11.80	17.75	3.01	6.80	A++
	2.00	2.00	2.00	2.50	—	2.00	2.00	2.00	2.60	—	3.20	8.60	11.00	0.55	2.78	4.00	2.44	12.33	17.75	3.09	6.80	A++
	2.00	2.00	2.00	3.50	—	1.88	1.88	1.88	3.38	—	3.20	9.00	11.00	0.55	2.86	4.00	2.44	12.69	17.75	3.15	6.80	A++
	2.00	2.00	2.00	4.20	—	1.73	1.73	1.73	3.81	—	3.20	9.00	11.00	0.55	2.92	4.10	2.44	12.95	18.19	3.08	6.80	A++
	2.00	2.00	2.00	5.00	—	1.61	1.61	1.61	4.18	—	3.20	9.00	11.00	0.55	2.91	4.10	2.44	12.91	18.19	3.09	6.80	A++
	2.00	2.00	2.00	7.10	—	1.44	1.44	1.44	4.68	—	3.20	9.00	11.00	0.55	2.91	4.10	2.44	12.91	18.19	3.09	6.70	A++
	2.00	2.00	2.50	2.50	—	1.96	1.96	2.54	2.54	—	3.20	9.00	11.00	0.55	2.83	4.00	2.44	12.56	17.75	3.18	6.80	A++
	2.00	2.00	2.50	3.50	—	1.76	1.76	2.29	3.18	—	3.20	9.00	11.00	0.55	2.91	4.10	2.44	12.91	18.19	3.09	6.80	A++
	2.00	2.00	2.50	4.20	—	1.64	1.64	2.13	3.60	—	3.20	9.00	11.00	0.55	2.91	4.10	2.44	12.91	18.19	3.09	6.80	A++
	2.00	2.00	2.50	5.00	—	1.53	1.53	1.98	3.97	—	3.20	9.00	11.00	0.55	2.91	4.10	2.44	12.91	18.19	3.09	6.80	A++
	2.00	2.00	2.50	7.10	—	1.37	1.37	1.79	4.47	—	3.20	9.00	11.00	0.55	2.92	4.10	2.44	12.95	18.19	3.08	6.70	A++
	2.00	2.00	3.50	3.50	—	1.61	1.61	2.89	2.89	—	3.20	9.00	11.00	0.55	2.91	4.10	2.44	12.91	18.19	3.09	6.80	A++
	2.00	2.00	3.50	4.20	—	1.50	1.50	2.70	3.30	—	3.20	9.00	11.00	0.55	2.92	4.10	2.44	12.95	18.19	3.08	6.70	A++
	2.00	2.00	3.50	5.00	—	1.41	1.41	2.53	3.66	—	3.20	9.00	11.00	0.55	2.91	4.10	2.44	12.91	18.19	3.09	6.70	A++
	2.00	2.00	4.20	4.20	—	1.41	1.41	3.09	3.09	—	3.20	9.00	11.00	0.55	2.92	4.10	2.44	12.95	18.19	3.08	6.90	A++
	2.00	2.00	4.20	5.00	—	1.32	1.32	2.91	3.44	—	3.20	9.00	11.00	0.55	2.92	4.10	2.44	12.95	18.19	3.08	6.90	A++
	2.00	2.00	5.00	5.00	—	1.25	1.25	3.25	3.25	—	3.20	9.00	11.00	0.55	2.92	4.10	2.44	12.95	18.19	3.08	6.90	A++
	2.00	2.50	2.50	2.50	—	1.84	2.39	2.39	2.39	—	3.20	9.00	11.00	0.55	2.85	4.00	2.44	12.64	17.75	3.16	6.90	A++
	2.00	2.50	2.50	3.50	—	1.67	2.17	2.17	3.00	—	3.20	9.00	11.00	0.55	2.90	4.10	2.44	12.87	18.19	3.10	6.90	A++
	2.00	2.50	2.50	4.20	—	1.55	2.02	2.02	3.41	—	3.20	9.00	11.00	0.55	2.91	4.10	2.44	12.91	18.19	3.09	6.90	A++
	2.00	2.50	2.50	5.00	—	1.45	1.89	1.89	3.77	—	3.20	9.00	11.00	0.55	2.90	4.10	2.44	12.87	18.19	3.10	6.90	A++
	2.00	2.50	3.50	3.50	—	1.53	1.98	2.75	2.75	—	3.20	9.00	11.00	0.55	2.84	4.10	2.44	12.60	18.19	3.17	6.90	A++
	2.00	2.50	3.50	4.20	—	1.43	1.86	2.57	3.14	—	3.20	9.00	11.00	0.55	2.87	4.10	2.44	12.73	18.19	3.14	6.90	A++
	2.00	2.50	3.50	5.00	—	1.34	1.75	2.42	3.49	—	3.20	9.00	11.00	0.55	2.86	4.10	2.44	12.69	18.19	3.15	6.90	A++
	2.00	2.50	4.20	4.20	—	1.34	1.75	2.96	2.96	—	3.20	9.00	11.00	0.55	2.85	4.10	2.44	12.64	18.19	3.16	6.90	A++
	2.00	2.50	4.20	5.00	—	1.27	1.65	2.79	3.30	—	3.20	9.00	11.00	0.55	2.90	4.10	2.44	12.87	18.19	3.10	6.90	A++
	2.00	3.50	3.50	3.50	—	1.41	2.53	2.53	2.53	—	3.20	9.00	11.00	0.55	2.87	4.10	2.44	12.73	18.19	3.14	6.90	A++
	2.00	3.50	3.50	4.20	—	1.32	2.38	2.38	2.91	—	3.20	9.00	11.00	0.55	2.89	4.10	2.44	12.82	18.19	3.11	6.90	A++
	2.00	3.50	3.50	5.00	—	1.25	2.25	2.25	3.25	—	3.20	9.00	11.00	0.55	2.93	4.10	2.44	13.00	18.19	3.07	6.90	A++
	2.00	3.50	4.20	4.20	—	1.25	2.25	2.75	2.75	—	3.20	9.00	11.00	0.55	2.91	4.10	2.44	12.91	18.19	3.09	6.90	A++
	2.00	4.20	4.20	4.20	—	1.18	2.61	2.61	2.61	—	3.20	9.00	11.00	0.55	2.92	4.10	2.44	12.95	18.19	3.08	6.90	A++
	2.50	2.50	2.50	2.50	—	2.25	2.25	2.25	2.25	—	3.20	9.00	11.00	0.55	2.87	4.10	2.44	12.73	18.19	3.14	6.90	A++
2.50	2.50	2.50	3.50	—	2.05	2.05	2.05	2.84	—	3.20	9.00	11.00	0.55	2.81	4.10	2.44	12.47	18.19	3.20	6.90	A++	
2.50	2.50	2.50	4.20	—	1.92	1.92	1.92	3.25	—	3.20	9.00	11.00	0.55	2.76	4.10	2.44	12.24	18.19	3.26	6.90	A++	
2.50	2.50	2.50	5.00	—	1.80	1.80	1.80	3.60	—	3.20	9.00	11.00	0.55	2.78	4.10	2.44	12.33	18.19	3.24	6.90	A++	
2.50	2.50	3.50	3.50	—	1.89	1.89	2.61	2.61	—	3.20	9.00	11.00	0.55	2.81	4.10	2.44	12.47	18.19	3.20	6.90	A++	
2.50	2.50	3.50	4.20	—	1.77	1.77	2.45	3.00	—	3.20	9.00	11.00	0.55	2.80	4.10	2.44	12.42	18.19	3.21	7.00	A++	
2.50	2.50	3.50	5.00	—	1.67	1.67	2.31	3.34	—	3.20	9.00	11.00	0.55	2.79	4.10	2.44	12.38	18.19	3.23	7.00	A++	
2.50	2.50	4.20	4.20	—	1.67	1.67	2.83	2.83	—	3.20	9.00	11.00	0.55	2.79	4.10	2.44	12.38	18.19	3.23	7.00	A++	
2.50	3.50	3.50	3.50	—	1.75	2.42	2.42	2.42	—	3.20	9.00	11.00	0.55	2.79	4.10	2.44	12.38	18.19	3.23	7.00	A++	
2.50	3.50	3.50	4.20	—	1.65	2.28	2.28	2.79	—	3.20	9.00	11.00	0.55	2.79	4.10	2.44	12.38	18.19	3.23	7.00	A++	
3.50	3.50	3.50	3.50	—	2.25	2.25	2.25	2.25	—	3.20	9.00	11.00	0.55	2.79	4.10	2.44	12.38	18.19	3.23	7.00	A++	
5	2.00	2.00	2.00	2.00	2.00	1.80	1.80	1.80	1.80	1.80	3.20	9.00	11.00	0.55	2.79	4.10	2.44	12.38	18.19	3.23	7.00	A++
	2.00	2.00	2.00	2.00	2.50	1.70	1.70	1.70	1.70	2.21	3.20	9.00	11.00	0.55	2.79	4.10	2.44	12.38	18.19	3.23	7.00	A++
	2.00	2.00	2.00	2.00	3.50	1.55	1.55	1.55	1.55	2.79	3.20	9.00	11.00	0.55	2.79	4.10	2.44	12.38	18.19	3.23	7.00	A++
	2.00	2.00	2.00	2.00	4.20	1.45	1.45	1.45	1.45	3.19	3.20	9.00	11.00	0.55	2.79	4.10	2.44	12.38	18.19	3.23	7.00	A++
	2.00	2.00	2.00	2.00	5.00	1.36	1.36	1.36	1.36	3.55	3.20	9.00	11.00	0.55	2.79	4.10	2.44	12.38	18.19	3.23	7.00	A++
	2.00	2.00	2.00	2.50	2.50	1.61	1.61	1.61	2.09	2.09	3.20	9.00	11.00	0.55	2.79	4.10	2.44	12.38	18.19	3.23	7.00	A++
	2.00	2.00	2.00	2.50	3.50	1.48	1.48	1.48	1.92	2.66	3.20	9.00	11.00	0.55	2.79	4.10	2.44	12.38	18.19	3.23	7.00	A++
	2.00	2.00	2.00	2.50	4.20	1.38	1.38	1.38	1.80	3.05	3.20	9.00	11.00	0.55	2.79	4.10	2.44	12.38	18.19	3.23	7.00	A++
	2.00	2.00	2.00	2.50	5.00	1.30	1.30	1.30	1.70	3.39	3.20	9.00	11.00	0.55	2.79	4.10	2.44	12.38	18.19	3.23	7.00	A++
	2.00	2.00	2.00	3.50	3.50	1.36	1.36	1.36	2.45	2.45	3.20	9.00	11.00	0.55	2.79	4.10	2.44	12.38	18.19	3.23	7.00	A++
	2.00	2.00	2.00	3.50	4.20	1.29	1.29	1.29	2.31	2.83	3.20	9.00	11.00	0.55	2.79	4.10	2.44	12.38	18.19	3.23	7.00	A++
	2.00	2.00	2.50	2.50	2.50	1.53	1.53	1.98	1.98	1.98	3.20	9.00	11.00	0.55	2.79	4.10	2.44	12.38	18.19	3.23	7.00	A++
	2.00	2.00	2.50	2.50	3.50	1.41	1.41	1.83	1.83	2.53	3.20	9.00	11.00	0.55	2.79	4.10	2.44	12.38	18.19	3.23	7.00	A++
	2.00	2.00	2.50	2.50	4.20	1.32	1.32	1.72	1.72	2.91	3.20	9.00	11.00	0.55	2.79	4.10	2.44	12.38	18.19	3.23	7.00	A++
	2.00	2.00	2.50	2.50	5.00	1.25	1.25	1.63	1.63	3.25	3.20	9.00	11.00	0.55	2.79	4.10	2.44	12.38	18.19	3.23	7.00	A++
	2.00	2.00	2.50	3.50	3.50	1.30	1.30	1.70	2.35	2.35	3.20	9.00	11.00	0.55	2.79	4.10	2.44	12.38	18.19	3.23	7.00	A++
	2.00	2.50	2.50	2.50	2.50	1.45	1.89	1.89	1.89	1.89	3.20	9.00	11.00	0.55	2.79	4.10	2.44	12.38	18.19	3.23	7.00	A++
	2.00	2.50	2.50	2.50	3.50	1.34	1.75	1.75	1.75	2.42	3.20	9.00	11.00	0.55	2.79	4.1						

MULTISPLIT COMBINATIONS TABLE

5U90S2SS5FA Inverter (The values in the table refer to the FLEXIS series)

HEATING																						
Combinations					Output power (kW)					System output power (kW)			Absorbed power (kW)			Absorbed current (A)			COP	SCOP	Energy class	
UI	A	B	C	D	E	A	B	C	D	E	min	nom	max	min	nom	max	min	nom	max			
2	2.00	2.00	—	—	—	2.30	2.30	—	—	—	2.80	4.60	8.00	0.55	1.30	3.30	2.44	5.77	14.64	3.54	3.75	A
	2.00	2.50	—	—	—	2.30	3.60	—	—	—	3.00	5.90	10.00	0.55	1.66	3.30	2.44	7.36	14.64	3.55	3.75	A
	2.00	3.50	—	—	—	2.30	4.50	—	—	—	3.20	6.80	10.00	0.55	1.90	3.30	2.44	8.43	14.64	3.58	3.75	A
	2.00	4.20	—	—	—	2.30	5.40	—	—	—	3.40	7.70	10.00	0.55	2.15	3.30	2.44	9.54	14.64	3.58	3.80	A
	2.00	5.00	—	—	—	2.30	6.00	—	—	—	3.80	8.30	11.50	0.55	2.29	3.30	2.44	10.16	14.64	3.62	3.80	A
	2.00	7.10	—	—	—	2.30	7.00	—	—	—	4.00	9.30	11.50	0.55	2.55	3.30	2.44	11.31	14.64	3.65	3.85	A
	2.50	2.50	—	—	—	3.60	3.60	—	—	—	3.40	7.20	10.50	0.55	2.02	3.30	2.44	8.96	14.64	3.56	3.85	A
	2.50	3.50	—	—	—	3.60	4.50	—	—	—	3.80	8.10	10.50	0.55	2.26	3.30	2.44	10.03	14.64	3.58	3.83	A
	2.50	4.20	—	—	—	3.60	5.40	—	—	—	4.00	9.00	10.50	0.55	2.50	3.30	2.44	11.09	14.64	3.60	3.87	A
	2.50	5.00	—	—	—	3.60	6.00	—	—	—	4.40	9.60	10.50	0.55	2.64	3.30	2.44	11.71	14.64	3.64	3.85	A
	2.50	7.10	—	—	—	3.53	6.87	—	—	—	4.40	10.40	11.00	0.55	2.85	3.30	2.44	12.64	14.64	3.65	3.84	A
	3.50	3.50	—	—	—	4.50	4.50	—	—	—	4.00	9.00	10.50	0.55	2.50	3.30	2.44	11.09	14.64	3.60	3.86	A
	3.50	4.20	—	—	—	4.50	5.40	—	—	—	4.40	9.90	10.50	0.55	2.74	3.30	2.44	12.16	14.64	3.61	3.82	A
	3.50	5.00	—	—	—	4.46	5.94	—	—	—	4.40	10.40	11.50	0.55	2.88	3.30	2.44	12.78	14.64	3.61	3.80	A
	3.50	7.10	—	—	—	4.07	6.33	—	—	—	4.40	10.40	11.50	0.55	2.88	3.30	2.44	12.78	14.64	3.61	3.84	A
	4.20	4.20	—	—	—	5.20	5.20	—	—	—	4.40	10.40	11.50	0.55	2.88	3.30	2.44	12.78	14.64	3.61	3.86	A
	4.20	5.00	—	—	—	4.93	5.47	—	—	—	4.40	10.40	11.50	0.55	2.88	3.30	2.44	12.78	14.64	3.61	3.83	A
	4.20	7.10	—	—	—	4.53	5.87	—	—	—	4.40	10.40	11.50	0.55	2.88	3.30	2.44	12.78	14.64	3.61	3.86	A
5.00	5.00	—	—	—	5.20	5.20	—	—	—	4.40	10.40	11.50	0.55	2.88	3.30	2.44	12.78	14.64	3.61	3.80	A	
5.00	7.10	—	—	—	4.80	5.60	—	—	—	4.40	10.40	11.50	0.55	2.88	3.30	2.44	12.78	14.64	3.61	3.87	A	
7.10	7.10	—	—	—	5.20	5.20	—	—	—	4.40	10.40	11.50	0.55	2.88	3.30	2.44	12.78	14.64	3.61	3.87	A	
3	2.00	2.00	2.00	—	—	2.30	2.30	2.30	—	—	3.80	6.90	11.50	0.55	1.93	3.40	2.44	8.56	15.08	3.58	3.80	A
	2.00	2.00	2.50	—	—	2.30	2.30	3.60	—	—	4.00	8.20	11.50	0.55	2.28	3.40	2.44	10.12	15.08	3.60	3.80	A
	2.00	2.00	3.50	—	—	2.30	2.30	4.50	—	—	4.20	9.10	11.50	0.55	2.50	3.40	2.44	11.09	15.08	3.64	3.80	A
	2.00	2.00	4.20	—	—	2.30	2.30	5.40	—	—	4.40	10.00	11.50	0.55	2.73	3.40	2.44	12.11	15.08	3.66	3.80	A
	2.00	2.00	5.00	—	—	2.26	2.26	5.89	—	—	4.40	10.40	11.50	0.55	2.88	3.40	2.44	12.78	15.08	3.61	3.80	A
	2.00	2.00	7.10	—	—	2.06	2.06	6.28	—	—	4.40	10.40	11.50	0.55	2.88	3.40	2.44	12.78	15.08	3.61	3.80	A
	2.00	2.50	2.50	—	—	2.30	3.60	3.60	—	—	4.40	9.50	11.50	0.55	2.63	3.40	2.44	11.67	15.08	3.61	3.80	A
	2.00	2.50	3.50	—	—	2.30	3.60	4.50	—	—	4.40	10.40	11.50	0.55	2.88	3.40	2.44	12.78	15.08	3.61	3.80	A
	2.00	2.50	4.20	—	—	2.12	3.31	4.97	—	—	4.40	10.40	11.50	0.55	2.88	3.40	2.44	12.78	15.08	3.61	3.80	A
	2.00	2.50	5.00	—	—	2.01	3.15	5.24	—	—	4.40	10.40	11.50	0.55	2.88	3.40	2.44	12.78	15.08	3.61	3.82	A
	2.00	2.50	7.10	—	—	1.85	2.90	5.64	—	—	4.40	10.40	11.50	0.55	2.88	3.40	2.44	12.78	15.08	3.61	3.82	A
	2.00	3.50	3.50	—	—	2.12	4.14	4.14	—	—	4.40	10.40	11.50	0.55	2.88	3.40	2.44	12.78	15.08	3.61	3.82	A
	2.00	3.50	4.20	—	—	1.96	3.84	4.60	—	—	4.40	10.40	11.50	0.55	2.88	3.40	2.44	12.78	15.08	3.61	3.82	A
	2.00	3.50	5.00	—	—	1.87	3.66	4.88	—	—	4.40	10.40	11.50	0.55	2.88	3.40	2.44	12.78	15.08	3.61	3.82	A
	2.00	3.50	7.10	—	—	1.73	3.39	5.28	—	—	4.40	10.40	11.50	0.55	2.86	3.40	2.44	12.69	15.08	3.64	3.82	A
	2.00	4.20	4.20	—	—	1.83	4.29	4.29	—	—	4.40	10.40	11.50	0.55	2.86	3.40	2.44	12.69	15.08	3.64	3.82	A
	2.00	4.20	5.00	—	—	1.75	4.10	4.55	—	—	4.40	10.40	11.50	0.55	2.86	3.40	2.44	12.69	15.08	3.64	3.82	A
	2.00	4.20	7.10	—	—	1.63	3.82	4.95	—	—	4.40	10.40	11.50	0.55	2.86	3.40	2.44	12.69	15.08	3.64	3.87	A
	2.00	5.00	5.00	—	—	1.67	4.36	4.36	—	—	4.40	10.40	11.50	0.55	2.86	3.40	2.44	12.69	15.08	3.64	3.87	A
	2.50	2.50	2.50	—	—	3.47	3.47	3.47	—	—	4.40	10.40	11.50	0.55	2.85	3.40	2.44	12.64	15.08	3.65	3.87	A
	2.50	2.50	3.50	—	—	3.20	3.20	4.00	—	—	4.40	10.40	11.50	0.55	2.85	3.40	2.44	12.64	15.08	3.65	3.87	A
	2.50	2.50	4.20	—	—	2.97	2.97	4.46	—	—	4.40	10.40	11.50	0.55	2.85	3.40	2.44	12.64	15.08	3.65	3.87	A
	2.50	2.50	5.00	—	—	2.84	2.84	4.73	—	—	4.40	10.40	11.50	0.55	2.85	3.40	2.44	12.64	15.08	3.65	3.87	A
	2.50	2.50	7.10	—	—	2.64	2.64	5.13	—	—	4.40	10.40	11.50	0.55	2.85	3.40	2.44	12.64	15.08	3.65	3.90	A
	2.50	3.50	3.50	—	—	2.97	3.71	3.71	—	—	4.40	10.40	11.50	0.55	2.85	3.40	2.44	12.64	15.08	3.65	3.85	A
	2.50	3.50	4.20	—	—	2.77	3.47	4.16	—	—	4.40	10.40	11.50	0.55	2.85	3.40	2.44	12.64	15.08	3.65	3.85	A
	2.50	3.50	5.00	—	—	2.66	3.32	4.43	—	—	4.40	10.40	11.50	0.55	2.85	3.40	2.44	12.64	15.08	3.65	3.85	A
	2.50	3.50	7.10	—	—	2.48	3.10	4.82	—	—	4.40	10.40	11.50	0.55	2.85	3.40	2.44	12.64	15.08	3.65	3.85	A
	2.50	4.20	4.20	—	—	2.60	3.90	3.90	—	—	4.40	10.40	11.50	0.55	2.85	3.40	2.44	12.64	15.08	3.65	3.85	A
	2.50	4.20	5.00	—	—	2.50	3.74	4.16	—	—	4.40	10.40	11.50	0.55	2.85	3.40	2.44	12.64	15.08	3.65	3.85	A
	2.50	4.20	7.10	—	—	2.34	3.51	4.55	—	—	4.40	10.40	11.50	0.55	2.85	3.40	2.44	12.64	15.08	3.65	3.85	A
	2.50	5.00	5.00	—	—	2.40	4.00	4.00	—	—	4.40	10.40	11.50	0.55	2.85	3.40	2.44	12.64	15.08	3.65	3.85	A
	3.50	3.50	3.50	—	—	3.47	3.47	3.47	—	—	4.40	10.40	11.50	0.55	2.85	3.40	2.44	12.64	15.08	3.65	3.90	A
	3.50	3.50	4.20	—	—	3.25	3.25	3.90	—	—	4.40	10.40	11.50	0.55	2.85	3.40	2.44	12.64	15.08	3.65	3.90	A
	3.50	3.50	5.00	—	—	3.12	3.12	4.16	—	—	4.40	10.40	11.50	0.55	2.83	3.40	2.44	12.56	15.08	3.67	3.90	A
	3.50	3.50	7.10	—	—	2.93	2.93	4.55	—	—	4.40	10.40	11.50	0.55	2.83	3.40	2.44	12.56	15.08	3.67	3.90	A
3.50	4.20	4.20	—	—	3.06	3.67	3.67	—	—	4.40	10.40	11.50	0.55	2.83	3.40	2.44	12.56	15.08	3.67	3.90	A	
3.50	4.20	5.00	—	—	2.94	3.53	3.92	—	—	4.40	10.40	11.50	0.55	2.83	3.40	2.44	12.56	15.08	3.67	3.90	A	
3.50	5.00	5.00	—	—	2.84	3.78	3.78	—	—	4.40	10.40	11.50	0.55	2.83	3.40	2.44	12.56	15.08	3.67	3.90	A	
4.20	4.20	4.20	—	—	3.47	3.47	3.47	—	—	4.40	10.40	11.50	0.55	2.83	3.40	2.44	12.56	15.08	3.67	3.90	A	
4.20	4.20	5.00	—	—	3.34	3.34	3.71	—	—	4.40	10.40	11.50	0.55	2.83	3.40	2.44	12.56	15.08	3.67	3.90	A	

MULTISPLIT COMBINATIONS TABLE

5U90S2SS5FA Inverter (The values in the table refer to the FLEXIS series)

HEATING																							
Combinations					Output power (kW)					System output power (kW)			Absorbed power (kW)			Absorbed current (A)			COP	SCOP	Energy class		
UI	A	B	C	D	E	A	B	C	D	E	min	nom	max	min	nom	max	min	nom	max				
4	2.00	2.00	2.00	2.00	—	2.30	2.30	2.30	2.30	—	4.20	9.20	11.50	0.55	2.55	3.40	2.44	11.31	15.08	3.61	3.85	A	
	2.00	2.00	2.00	2.50	—	2.28	2.28	2.28	3.57	—	4.20	10.40	11.50	0.55	2.84	3.40	2.44	12.60	15.08	3.66	3.85	A	
	2.00	2.00	2.00	3.50	—	2.10	2.10	2.10	4.11	—	4.40	10.40	11.50	0.55	2.84	3.40	2.44	12.60	15.08	3.66	3.85	A	
	2.00	2.00	2.00	4.20	—	1.94	1.94	1.94	4.57	—	4.40	10.40	11.50	0.55	2.84	3.40	2.44	12.60	15.08	3.66	3.85	A	
	2.00	2.00	2.00	5.00	—	1.85	1.85	1.85	4.84	—	4.40	10.40	11.50	0.55	2.84	3.40	2.44	12.60	15.08	3.66	3.85	A	
	2.00	2.00	2.00	7.10	—	1.72	1.72	1.72	5.24	—	4.40	10.40	11.50	0.55	2.84	3.40	2.44	12.60	15.08	3.66	3.85	A	
	2.00	2.00	2.50	2.50	—	2.03	2.03	3.17	3.17	—	4.40	10.40	11.50	0.55	2.84	3.40	2.44	12.60	15.08	3.66	3.85	A	
	2.00	2.00	2.50	3.50	—	1.88	1.88	2.95	3.69	—	4.40	10.40	11.50	0.55	2.83	3.40	2.44	12.56	15.08	3.67	3.85	A	
	2.00	2.00	2.50	4.20	—	1.76	1.76	2.75	4.13	—	4.40	10.40	11.50	0.55	2.83	3.40	2.44	12.56	15.08	3.67	3.90	A	
	2.00	2.00	2.50	5.00	—	1.68	1.68	2.64	4.39	—	4.40	10.40	11.50	0.55	2.83	3.40	2.44	12.56	15.08	3.67	3.90	A	
	2.00	2.00	2.50	7.10	—	1.57	1.57	2.46	4.79	—	4.40	10.40	11.50	0.55	2.83	3.40	2.44	12.56	15.08	3.67	3.90	A	
	2.00	2.00	3.50	3.50	—	1.76	1.76	3.44	3.44	—	4.40	10.40	11.50	0.55	2.83	3.40	2.44	12.56	15.08	3.67	3.90	A	
	2.00	2.00	3.50	4.20	—	1.65	1.65	3.23	3.87	—	4.40	10.40	11.50	0.55	2.83	3.40	2.44	12.56	15.08	3.67	3.90	A	
	2.00	2.00	3.50	5.00	—	1.58	1.58	3.10	4.13	—	4.40	10.40	11.50	0.55	2.81	3.40	2.44	12.47	15.08	3.70	3.90	A	
	2.00	2.00	4.20	4.20	—	1.55	1.55	3.65	3.65	—	4.40	10.40	11.50	0.55	2.81	3.40	2.44	12.47	15.08	3.70	3.90	A	
	2.00	2.00	4.20	5.00	—	1.50	1.50	3.51	3.90	—	4.40	10.40	11.50	0.55	2.81	3.40	2.44	12.47	15.08	3.70	3.90	A	
	2.00	2.00	5.00	5.00	—	1.44	1.44	3.76	3.76	—	4.40	10.40	11.50	0.55	2.81	3.40	2.44	12.47	15.08	3.70	3.90	A	
	2.00	2.50	2.50	2.50	—	1.83	2.86	2.86	2.86	—	4.40	10.40	11.50	0.55	2.81	3.40	2.44	12.47	15.08	3.70	3.90	A	
	2.00	2.50	2.50	3.50	—	1.71	2.67	2.67	3.34	—	4.40	10.40	11.50	0.55	2.81	3.40	2.44	12.47	15.08	3.70	3.90	A	
	2.00	2.50	2.50	4.20	—	1.61	2.51	2.51	3.77	—	4.40	10.40	11.50	0.55	2.81	3.40	2.44	12.47	15.08	3.70	3.95	A	
	2.00	2.50	2.50	5.00	—	1.54	2.42	2.42	4.03	—	4.40	10.40	11.50	0.55	2.83	3.40	2.44	12.56	15.08	3.67	3.95	A	
	2.00	2.50	3.50	3.50	—	1.61	2.51	3.14	3.14	—	4.40	10.40	11.50	0.55	2.80	3.40	2.44	12.42	15.08	3.71	3.95	A	
	2.00	2.50	3.50	4.20	—	1.51	2.37	2.96	3.55	—	4.40	10.40	11.50	0.55	2.81	3.40	2.44	12.47	15.08	3.70	3.95	A	
	2.00	2.50	3.50	5.00	—	1.46	2.28	2.85	3.80	—	4.40	10.40	11.50	0.55	2.83	3.40	2.44	12.56	15.08	3.67	3.95	A	
	2.00	2.50	4.20	4.20	—	1.43	2.24	3.36	3.36	—	4.40	10.40	11.50	0.55	2.81	3.40	2.44	12.47	15.08	3.70	3.95	A	
	2.00	2.50	4.20	5.00	—	1.38	2.16	3.25	3.61	—	4.40	10.40	11.50	0.55	2.82	3.40	2.44	12.51	15.08	3.69	3.95	A	
	2.00	3.50	3.50	3.50	—	1.51	2.96	2.96	2.96	—	4.40	10.40	11.50	0.55	2.80	3.40	2.44	12.42	15.08	3.71	3.95	A	
	2.00	3.50	3.50	4.20	—	1.43	2.80	2.80	3.36	—	4.40	10.40	11.50	0.55	2.80	3.40	2.44	12.42	15.08	3.71	4.00	A+	
	2.00	3.50	3.50	5.00	—	1.38	2.71	2.71	3.61	—	4.40	10.40	11.50	0.55	2.83	3.40	2.44	12.56	15.08	3.67	4.00	A+	
	2.00	3.50	4.20	4.20	—	1.36	2.66	3.19	3.19	—	4.40	10.40	11.50	0.55	2.82	3.40	2.44	12.51	15.08	3.69	4.00	A+	
	2.00	4.20	4.20	4.20	—	1.29	3.04	3.04	3.04	—	4.40	10.40	11.50	0.55	2.81	3.40	2.44	12.47	15.08	3.70	4.00	A+	
	2.50	2.50	2.50	2.50	—	2.60	2.60	2.60	2.60	—	4.40	10.40	11.50	0.55	2.76	3.40	2.44	12.24	15.08	3.77	4.00	A+	
	2.50	2.50	2.50	3.50	—	2.45	2.45	2.45	3.06	—	4.40	10.40	11.50	0.55	2.80	3.40	2.44	12.42	15.08	3.71	4.00	A+	
	2.50	2.50	2.50	4.20	—	2.31	2.31	2.31	3.47	—	4.40	10.40	11.50	0.55	2.80	3.40	2.44	12.42	15.08	3.71	4.00	A+	
	2.50	2.50	2.50	5.00	—	2.23	2.23	2.23	3.71	—	4.40	10.40	11.50	0.55	2.81	3.40	2.44	12.47	15.08	3.70	4.00	A+	
	2.50	2.50	3.50	3.50	—	2.31	2.31	2.89	2.89	—	4.40	10.40	11.50	0.55	2.79	3.40	2.44	12.38	15.08	3.73	4.00	A+	
2.50	2.50	3.50	4.20	—	2.19	2.19	2.74	3.28	—	4.40	10.40	11.50	0.55	2.79	3.40	2.44	12.38	15.08	3.73	4.00	A+		
2.50	2.50	3.50	5.00	—	2.12	2.12	2.64	3.53	—	4.40	10.40	11.50	0.55	2.79	3.40	2.44	12.38	15.08	3.73	4.00	A+		
2.50	2.50	4.20	4.20	—	2.08	2.08	3.12	3.12	—	4.40	10.40	11.50	0.55	2.79	3.40	2.44	12.38	15.08	3.73	4.00	A+		
2.50	3.50	3.50	3.50	—	2.19	2.74	2.74	2.74	—	4.40	10.40	11.50	0.55	2.79	3.40	2.44	12.38	15.08	3.73	4.00	A+		
2.50	3.50	3.50	4.20	—	2.08	2.60	2.60	3.12	—	4.40	10.40	11.50	0.55	2.79	3.40	2.44	12.38	15.08	3.73	4.00	A+		
3.50	3.50	3.50	3.50	—	2.60	2.60	2.60	2.60	—	4.40	10.40	11.50	0.55	2.79	3.40	2.44	12.38	15.08	3.73	4.00	A+		
5	2.00	2.00	2.00	2.00	2.00	2.08	2.08	2.08	2.08	2.08	4.20	10.40	11.50	0.55	2.79	3.40	2.44	12.38	15.08	3.73	4.00	A+	
	2.00	2.00	2.00	2.00	2.50	1.87	1.87	1.87	1.87	2.93	4.20	10.40	11.50	0.55	2.79	3.40	2.44	12.38	15.08	3.73	4.00	A+	
	2.00	2.00	2.00	2.00	3.50	1.75	1.75	1.75	1.75	3.42	4.20	10.40	11.50	0.55	2.79	3.40	2.44	12.38	15.08	3.73	4.00	A+	
	2.00	2.00	2.00	2.00	4.20	1.64	1.64	1.64	1.64	3.85	4.20	10.40	11.50	0.55	2.79	3.40	2.44	12.38	15.08	3.73	4.00	A+	
	2.00	2.00	2.00	2.00	5.00	1.57	1.57	1.57	1.57	4.11	4.20	10.40	11.50	0.55	2.79	3.40	2.44	12.38	15.08	3.73	4.00	A+	
	2.00	2.00	2.00	2.50	2.50	1.70	1.70	1.70	2.66	2.66	4.20	10.40	11.50	0.55	2.79	3.40	2.44	12.38	15.08	3.73	4.00	A+	
	2.00	2.00	2.00	2.50	3.50	1.59	1.59	1.59	2.50	3.12	4.20	10.40	11.50	0.55	2.79	3.40	2.44	12.38	15.08	3.73	4.00	A+	
	2.00	2.00	2.00	2.50	4.20	1.50	1.50	1.50	2.35	3.53	4.20	10.40	11.50	0.55	2.79	3.40	2.44	12.38	15.08	3.73	4.00	A+	
	2.00	2.00	2.00	2.50	5.00	1.45	1.45	1.45	2.27	3.78	4.20	10.40	11.50	0.55	2.79	3.40	2.44	12.38	15.08	3.73	4.00	A+	
	2.00	2.00	2.00	3.50	3.50	1.50	1.50	1.50	2.94	2.94	4.40	10.40	11.50	0.55	2.79	3.40	2.44	12.38	15.08	3.73	4.00	A+	
	2.00	2.00	2.00	3.50	4.20	1.42	1.42	1.42	2.79	3.34	4.40	10.40	11.50	0.55	2.79	3.40	2.44	12.38	15.08	3.73	4.00	A+	
	2.00	2.00	2.50	2.50	2.50	1.55	1.55	2.43	2.43	2.43	4.40	10.40	11.50	0.55	2.79	3.40	2.44	12.38	15.08	3.73	4.00	A+	
	2.00	2.00	2.50	2.50	3.50	1.47	1.47	2.30	2.30	2.87	4.40	10.40	11.50	0.55	2.79	3.40	2.44	12.38	15.08	3.73	4.00	A+	
	2.00	2.00	2.50	2.50	4.20	1.39	1.39	2.18	2.18	3.27	4.40	10.40	11.50	0.55	2.79	3.40	2.44	12.38	15.08	3.73	4.00	A+	
	2.00	2.00	2.50	2.50	5.00	1.34	1.34	2.10	2.10	3.51	4.40	10.40	11.50	0.55	2.79	3.40	2.44	12.38	15.08	3.73	4.00	A+	
	2.00	2.00	2.50	3.50	3.50	1.39	1.39	2.18	2.72	2.72	4.40	10.40	11.50	0.55	2.79	3.40	2.44	12.38	15.08	3.73	4.00	A+	
	2.00	2.50	2.50	2.50	2.50	1.43	2.24	2.24	2.24	2.24	4.40	10.40	11.50	0.55	2.79	3.40	2.44	12.38	15.08	3.73	4.00	A+	
	2.00	2.50	2.50	2.50	3.50	1.36	2.13	2.13	2.13	2.66	4.40	10.40	11.50	0.55	2.79	3.40							

MULTISPLIT COMBINATIONS TABLE

5U105S2SS5FA Inverter (The values in the table refer to the FLEXIS series)

COOLING																						
Combinations					Output power (kW)					System output power (kW)			Absorbed power (kW)			Absorbed current (A)			EER	SEER	Energy class	
UI	A	B	C	D	E	A	B	C	D	E	min	nom	max	min	nom	max	min	nom	max	EER	SEER	Energy class
2	2.00	2.00	—	—	—	2.00	2.00	—	—	—	2.50	4.00	5.60	0.55	1.50	3.60	2.44	6.65	15.97	—	—	—
	2.00	2.50	—	—	—	2.00	2.60	—	—	—	2.50	4.60	6.70	0.55	1.67	3.60	2.44	7.41	15.97	2.75	6.20	A++
	2.00	3.50	—	—	—	2.00	3.60	—	—	—	2.50	5.60	8.10	0.55	2.03	3.60	2.44	9.01	15.97	2.76	6.20	A++
	2.00	4.20	—	—	—	2.00	4.40	—	—	—	2.50	6.40	7.80	0.55	2.30	3.60	2.44	10.20	15.97	2.78	6.20	A++
	2.00	5.00	—	—	—	2.00	5.20	—	—	—	2.50	7.20	9.30	0.55	2.58	3.60	2.44	11.45	15.97	2.79	6.20	A++
	2.00	7.10	—	—	—	2.00	6.50	—	—	—	2.50	8.50	9.30	0.55	3.02	3.60	2.44	13.40	15.97	2.81	6.20	A++
	2.50	2.50	—	—	—	2.60	2.60	—	—	—	2.50	5.20	7.80	0.55	1.90	3.60	2.44	8.43	15.97	2.74	6.20	A++
	2.50	3.50	—	—	—	2.60	3.60	—	—	—	2.50	6.20	9.10	0.55	2.24	3.60	2.44	9.94	15.97	2.77	6.20	A++
	2.50	4.20	—	—	—	2.60	4.40	—	—	—	2.50	7.00	9.30	0.55	2.52	3.60	2.44	11.18	15.97	2.78	6.20	A++
	2.50	5.00	—	—	—	2.60	5.20	—	—	—	2.50	7.80	9.30	0.55	2.79	3.60	2.44	12.38	15.97	2.80	6.20	A++
	2.50	7.10	—	—	—	2.60	6.50	—	—	—	2.50	9.10	9.30	0.55	3.17	3.60	2.44	14.06	15.97	2.87	6.20	A++
	3.50	3.50	—	—	—	3.60	3.60	—	—	—	2.50	7.20	9.30	0.55	2.58	3.60	2.44	11.45	15.97	2.79	6.20	A++
	3.50	4.20	—	—	—	3.60	4.40	—	—	—	2.50	8.00	9.30	0.55	2.85	3.60	2.44	12.64	15.97	2.81	6.20	A++
	3.50	5.00	—	—	—	3.60	5.20	—	—	—	2.50	8.80	10.00	0.55	3.10	3.60	2.44	13.75	15.97	2.84	6.20	A++
	3.50	7.10	—	—	—	3.56	6.44	—	—	—	2.50	10.00	11.00	0.55	3.48	3.60	2.44	15.44	15.97	2.87	6.20	A++
	4.20	4.20	—	—	—	4.40	4.40	—	—	—	2.50	8.80	10.00	0.55	3.09	3.60	2.44	13.71	15.97	2.85	6.20	A++
	4.20	5.00	—	—	—	4.40	5.20	—	—	—	2.50	9.60	10.50	0.55	3.38	3.60	2.44	15.00	15.97	2.84	6.20	A++
	4.20	7.10	—	—	—	4.04	5.96	—	—	—	2.50	10.00	11.00	0.55	3.47	3.60	2.44	15.39	15.97	2.88	6.20	A++
	5.00	5.00	—	—	—	5.00	5.00	—	—	—	2.50	10.00	11.00	0.55	3.50	3.60	2.44	15.53	15.97	2.86	6.20	A++
	5.00	7.10	—	—	—	4.44	5.56	—	—	—	2.50	9.00	11.00	0.55	3.50	3.60	2.44	15.53	15.97	2.57	6.20	A++
	7.10	7.10	—	—	—	5.00	5.00	—	—	—	2.50	10.00	11.00	0.55	3.45	3.60	2.44	15.31	15.97	2.90	6.20	A++
3	2.00	2.00	2.00	—	—	2.00	2.00	2.00	—	—	3.00	6.00	9.50	0.55	2.20	3.80	2.44	9.76	16.86	2.73	6.70	A++
	2.00	2.00	2.50	—	—	2.00	2.00	2.60	—	—	3.00	6.60	9.50	0.55	2.40	3.80	2.44	10.65	16.86	2.75	6.70	A++
	2.00	2.00	3.50	—	—	2.00	2.00	3.60	—	—	3.00	7.60	9.50	0.55	2.75	3.80	2.44	12.20	16.86	2.76	6.70	A++
	2.00	2.00	4.20	—	—	2.00	2.00	4.40	—	—	3.20	8.40	9.50	0.55	3.00	3.80	2.44	13.31	16.86	2.80	6.70	A++
	2.00	2.00	5.00	—	—	2.00	2.00	5.20	—	—	3.20	9.20	10.00	0.55	3.20	3.80	2.44	14.20	16.86	2.88	6.70	A++
	2.00	2.00	7.10	—	—	1.90	1.90	6.19	—	—	3.20	10.00	11.00	0.55	3.45	4.10	2.44	15.31	18.19	2.90	6.70	A++
	2.00	2.50	2.50	—	—	2.00	2.60	2.60	—	—	3.20	7.20	9.50	0.55	2.60	3.80	2.44	11.54	16.86	2.77	6.70	A++
	2.00	2.50	3.50	—	—	2.00	2.60	3.60	—	—	3.20	8.20	9.50	0.55	2.93	3.80	2.44	13.00	16.86	2.80	6.70	A++
	2.00	2.50	4.20	—	—	2.00	2.60	4.40	—	—	3.20	9.00	10.00	0.55	3.20	3.80	2.44	14.20	16.86	2.81	6.70	A++
	2.00	2.50	5.00	—	—	2.00	2.60	5.20	—	—	3.20	9.80	11.00	0.55	3.44	3.80	2.44	15.26	16.86	2.85	6.70	A++
	2.00	2.50	7.10	—	—	1.80	2.34	5.86	—	—	3.20	10.00	11.00	0.55	3.50	4.10	2.44	15.53	18.19	2.86	6.70	A++
	2.00	3.50	3.50	—	—	2.00	3.60	3.60	—	—	3.20	9.20	11.00	0.55	3.38	3.80	2.44	15.00	16.86	2.72	6.70	A++
	2.00	3.50	4.20	—	—	2.00	3.60	4.40	—	—	3.20	10.00	11.00	0.55	3.50	4.10	2.44	15.53	18.19	2.86	6.70	A++
	2.00	3.50	5.00	—	—	1.85	3.33	4.81	—	—	3.20	10.00	11.00	0.55	3.50	4.10	2.44	15.53	18.19	2.86	6.70	A++
	2.00	3.50	7.10	—	—	1.65	2.98	5.37	—	—	3.20	10.00	11.00	0.55	3.50	4.10	2.44	15.53	18.19	2.86	6.70	A++
	2.00	4.20	4.20	—	—	1.85	4.07	4.07	—	—	3.20	10.00	11.00	0.55	3.50	4.10	2.44	15.53	18.19	2.86	6.70	A++
	2.00	4.20	5.00	—	—	1.72	3.79	4.48	—	—	3.20	10.00	11.00	0.55	3.50	4.10	2.44	15.53	18.19	2.86	6.70	A++
	2.00	4.20	7.10	—	—	1.55	3.41	5.04	—	—	3.20	10.00	11.00	0.55	3.50	4.10	2.44	15.53	18.19	2.86	6.70	A++
	2.00	5.00	5.00	—	—	1.61	4.19	4.19	—	—	3.20	10.00	11.00	0.55	3.50	4.10	2.44	15.53	18.19	2.86	6.70	A++
	2.00	5.00	7.10	—	—	1.46	3.80	4.74	—	—	3.20	10.00	11.00	0.55	3.50	4.10	2.44	15.53	18.19	2.86	6.70	A++
	2.50	2.50	2.50	—	—	2.60	2.60	2.60	—	—	3.20	7.80	9.50	0.55	2.78	3.80	2.44	12.33	16.86	2.81	6.72	A++
	2.50	2.50	3.50	—	—	2.60	2.60	3.60	—	—	3.20	8.80	10.00	0.55	3.14	3.80	2.44	13.93	16.86	2.80	6.72	A++
	2.50	2.50	4.20	—	—	2.60	2.60	4.40	—	—	3.20	9.60	11.00	0.55	3.40	3.80	2.44	15.08	16.86	2.82	6.74	A++
	2.50	2.50	5.00	—	—	2.50	2.50	5.00	—	—	3.20	10.00	11.00	0.55	3.50	4.10	2.44	15.53	18.19	2.86	6.74	A++
	2.50	2.50	7.10	—	—	2.22	2.22	5.56	—	—	3.20	10.00	11.00	0.55	3.50	4.10	2.44	15.53	18.19	2.86	6.70	A++
	2.50	3.50	3.50	—	—	2.60	3.60	3.60	—	—	3.20	9.80	11.00	0.55	3.45	3.80	2.44	15.31	16.86	2.84	6.73	A++
	2.50	3.50	4.20	—	—	2.45	3.40	4.15	—	—	3.20	10.00	11.00	0.55	3.50	4.10	2.44	15.53	18.19	2.86	6.70	A++
	2.50	3.50	5.00	—	—	2.28	3.16	4.56	—	—	3.20	10.00	11.00	0.55	3.50	4.10	2.44	15.53	18.19	2.86	6.70	A++
	2.50	3.50	7.10	—	—	2.05	2.83	5.12	—	—	3.20	10.00	11.00	0.55	3.50	4.10	2.44	15.53	18.19	2.86	6.70	A++
	2.50	4.20	4.20	—	—	2.28	3.86	3.86	—	—	3.20	10.00	11.00	0.55	3.50	4.10	2.44	15.53	18.19	2.86	6.70	A++
	2.50	4.20	5.00	—	—	2.13	3.61	4.26	—	—	3.20	10.00	11.00	0.55	3.50	4.10	2.44	15.53	18.19	2.86	6.70	A++
	2.50	4.20	7.10	—	—	1.93	3.26	4.81	—	—	3.20	10.00	11.00	0.55	3.50	4.10	2.44	15.53	18.19	2.86	6.70	A++
	2.50	5.00	5.00	—	—	2.00	4.00	4.00	—	—	3.20	10.00	11.00	0.55	3.50	4.10	2.44	15.53	18.19	2.86	6.70	A++
	2.50	5.00	7.10	—	—	1.82	3.64	4.55	—	—	3.20	10.00	11.00	0.55	3.50	4.10	2.44	15.53	18.19	2.86	6.70	A++
	3.50	3.50	3.50	—	—	3.33	3.33	3.33	—	—	3.20	10.00	11.00	0.55	3.50	4.10	2.44	15.53	18.19	2.86	6.75	A++
	3.50	3.50	4.20	—	—	3.10	3.10	3.79	—	—	3.20	10.00	11.00	0.55	3.50	4.10	2.44	15.53	18.19	2.86	6.70	A++
	3.50	3.50	5.00	—	—	2.90	2.90	4.19	—	—	3.20	10.00	11.00	0.55	3.45	4.10	2.44	15.31	18.19	2.90	6.70	A++
	3.50	3.50	7.10	—	—	2.63	2.63	4.74	—	—	3.20	10.00	11.00	0.55	3.45	4.10	2.44	15.31	18.19	2.90	6.70	A++
	3.50	4.20	4.20	—	—	2.90	3.55	3.55	—	—	3.20	10.00	11.00	0.55	3.45	4.10	2.44	15.31	18.19	2.90	6.75	A++
	3.50	4.20	5.00	—	—	2.73	3.33	3.94	—	—	3.20	10.00	11.00	0.55	3.45	4.10	2.44	15.31	18.19	2.90	6.75	A++
	3.50	5.00	5.00	—	—	2.57	3.71	3.71	—	—	3.20	10.00	11.00	0.55	3.45	4.10	2.44	15.31	18.19	2.90	6.75	A++
	4.20	4.20	4.20	—	—	3.33	3.33	3.33	—	—	3.20	10.00	11.00	0.55	3.45	4.10	2.44	15.31	18.19	2.90		

MULTISPLIT COMBINATIONS TABLE

5U10S2S5SFA Inverter (The values in the table refer to the FLEXIS series)

COOLING																						
Combinations					Output power (kW)					System output power (kW)			Absorbed power (kW)			Absorbed current (A)			EER	SEER	Energy class	
UI	A	B	C	D	E	A	B	C	D	E	min	nom	max	min	nom	max	min	nom	max			
4	2.00	2.00	2.00	2.00	—	2.00	2.00	2.00	2.00	—	3.20	8.00	11.00	0.55	2.80	4.00	2.44	12.42	17.75	2.86	6.80	A++
	2.00	2.00	2.00	2.50	—	2.00	2.00	2.00	2.60	—	3.20	8.60	11.00	0.55	3.00	4.00	2.44	13.31	17.75	2.87	6.80	A++
	2.00	2.00	2.00	3.50	—	2.00	2.00	2.00	3.60	—	3.20	9.60	11.00	0.55	3.30	4.00	2.44	14.64	17.75	2.91	6.80	A++
	2.00	2.00	2.00	4.20	—	1.92	1.92	1.92	4.23	—	3.20	10.00	11.00	0.55	3.40	4.10	2.44	15.08	18.19	2.94	6.80	A++
	2.00	2.00	2.00	5.00	—	1.79	1.79	1.79	4.64	—	3.20	10.00	11.00	0.55	3.40	4.10	2.44	15.08	18.19	2.94	6.80	A++
	2.00	2.00	2.00	7.10	—	1.60	1.60	1.60	5.20	—	3.20	10.00	11.00	0.55	3.40	4.10	2.44	15.08	18.19	2.94	6.70	A++
	2.00	2.00	2.50	2.50	—	2.00	2.00	2.60	2.60	—	3.20	9.20	11.00	0.55	3.20	4.00	2.44	14.20	17.75	2.88	6.80	A++
	2.00	2.00	2.50	3.50	—	1.96	1.96	2.55	3.53	—	3.20	10.00	11.00	0.55	3.40	4.10	2.44	15.08	18.19	2.94	6.80	A++
	2.00	2.00	2.50	4.20	—	1.82	1.82	2.36	4.00	—	3.20	10.00	11.00	0.55	3.40	4.10	2.44	15.08	18.19	2.94	6.80	A++
	2.00	2.00	2.50	5.00	—	1.69	1.69	2.20	4.41	—	3.20	10.00	11.00	0.55	3.40	4.10	2.44	15.08	18.19	2.94	6.80	A++
	2.00	2.00	2.50	7.10	—	1.53	1.53	1.98	4.96	—	3.20	10.00	11.00	0.55	3.40	4.10	2.44	15.08	18.19	2.94	6.70	A++
	2.00	2.00	3.50	3.50	—	1.79	1.79	3.21	3.21	—	3.20	10.00	11.00	0.55	3.40	4.10	2.44	15.08	18.19	2.94	6.80	A++
	2.00	2.00	3.50	4.20	—	1.67	1.67	3.00	3.67	—	3.20	10.00	11.00	0.55	3.40	4.10	2.44	15.08	18.19	2.94	6.70	A++
	2.00	2.00	3.50	5.00	—	1.56	1.56	2.81	4.06	—	3.20	10.00	11.00	0.55	3.40	4.10	2.44	15.08	18.19	2.94	6.70	A++
	2.00	2.00	3.50	7.10	—	1.42	1.42	2.55	4.61	—	3.20	10.00	11.00	0.55	3.40	4.10	2.44	15.08	18.19	2.94	6.70	A++
	2.00	2.00	4.20	4.20	—	1.56	1.56	3.44	3.44	—	3.20	10.00	11.00	0.55	3.40	4.10	2.44	15.08	18.19	2.94	6.90	A++
	2.00	2.00	4.20	5.00	—	1.47	1.47	3.24	3.82	—	3.20	10.00	11.00	0.55	3.40	4.10	2.44	15.08	18.19	2.94	6.90	A++
	2.00	2.00	5.00	5.00	—	1.39	1.39	3.61	3.61	—	3.20	10.00	11.00	0.55	3.40	4.10	2.44	15.08	18.19	2.94	6.90	A++
	2.00	2.50	2.50	2.50	—	2.00	2.60	2.60	2.60	—	3.20	9.80	11.00	0.55	3.37	4.00	2.44	14.95	17.75	2.91	6.90	A++
	2.00	2.50	2.50	3.50	—	1.85	2.41	2.41	3.33	—	3.20	10.00	11.00	0.55	3.40	4.10	2.44	15.08	18.19	2.94	6.90	A++
	2.00	2.50	2.50	4.20	—	1.72	2.24	2.24	3.79	—	3.20	10.00	11.00	0.55	3.40	4.10	2.44	15.08	18.19	2.94	6.90	A++
	2.00	2.50	2.50	5.00	—	1.61	2.10	2.10	4.19	—	3.20	10.00	11.00	0.55	3.40	4.10	2.44	15.08	18.19	2.94	6.90	A++
	2.00	2.50	2.50	7.10	—	1.46	1.90	1.90	4.74	—	3.20	10.00	11.00	0.55	3.40	4.10	2.44	15.08	18.19	2.94	6.90	A++
	2.00	2.50	3.50	3.50	—	1.69	2.20	3.05	3.05	—	3.20	10.00	11.00	0.55	3.38	4.10	2.44	15.00	18.19	2.96	6.90	A++
	2.00	2.50	3.50	4.20	—	1.59	2.06	2.86	3.49	—	3.20	10.00	11.00	0.55	3.38	4.10	2.44	15.00	18.19	2.96	6.90	A++
	2.00	2.50	3.50	5.00	—	1.49	1.94	2.69	3.88	—	3.20	10.00	11.00	0.55	3.38	4.10	2.44	15.00	18.19	2.96	6.90	A++
	2.00	2.50	4.20	4.20	—	1.49	1.94	3.28	3.28	—	3.20	10.00	11.00	0.55	3.38	4.10	2.44	15.00	18.19	2.96	6.90	A++
	2.00	2.50	4.20	5.00	—	1.41	1.83	3.10	3.66	—	3.20	10.00	11.00	0.55	3.38	4.10	2.44	15.00	18.19	2.96	6.90	A++
	2.00	2.50	5.00	5.00	—	1.33	1.73	3.47	3.47	—	3.20	10.00	11.00	0.55	3.38	4.10	2.44	15.00	18.19	2.96	6.90	A++
	2.00	3.50	3.50	3.50	—	1.56	2.81	2.81	2.81	—	3.20	10.00	11.00	0.55	3.38	4.10	2.44	15.00	18.19	2.96	6.90	A++
	2.00	3.50	3.50	4.20	—	1.47	2.65	2.65	3.24	—	3.20	10.00	11.00	0.55	3.38	4.10	2.44	15.00	18.19	2.96	6.90	A++
	2.00	3.50	3.50	5.00	—	1.39	2.50	2.50	3.61	—	3.20	10.00	11.00	0.55	3.36	4.10	2.44	14.91	18.19	2.98	6.90	A++
	2.00	3.50	4.20	4.20	—	1.39	2.50	3.06	3.06	—	3.20	10.00	11.00	0.55	3.36	4.10	2.44	14.91	18.19	2.98	6.90	A++
	2.00	3.50	4.20	5.00	—	1.32	2.37	2.89	3.42	—	3.20	10.00	11.00	0.55	3.36	4.10	2.44	14.91	18.19	2.98	6.90	A++
	2.00	4.20	4.20	4.20	—	1.32	2.89	2.89	2.89	—	3.20	10.00	11.00	0.55	3.36	4.10	2.44	14.91	18.19	2.98	6.90	A++
	2.50	2.50	2.50	2.50	—	2.50	2.50	2.50	2.50	—	3.20	10.00	11.00	0.55	3.36	4.10	2.44	14.91	18.19	2.98	6.90	A++
	2.50	2.50	2.50	3.50	—	2.28	2.28	2.28	3.16	—	3.20	10.00	11.00	0.55	3.36	4.10	2.44	14.91	18.19	2.98	6.90	A++
	2.50	2.50	2.50	4.20	—	2.13	2.13	2.13	3.61	—	3.20	10.00	11.00	0.55	3.36	4.10	2.44	14.91	18.19	2.98	6.90	A++
	2.50	2.50	2.50	5.00	—	2.00	2.00	2.00	4.00	—	3.20	10.00	11.00	0.55	3.36	4.10	2.44	14.91	18.19	2.98	6.90	A++
	2.50	2.50	2.50	7.10	—	1.82	1.82	1.82	4.55	—	3.20	10.00	11.00	0.55	3.36	4.10	2.44	14.91	18.19	2.98	6.90	A++
	2.50	2.50	3.50	3.50	—	2.10	2.10	2.90	2.90	—	3.20	10.00	11.00	0.55	3.36	4.10	2.44	14.91	18.19	2.98	6.90	A++
	2.50	2.50	3.50	4.20	—	1.97	1.97	2.73	3.33	—	3.20	10.00	11.00	0.55	3.36	4.10	2.44	14.91	18.19	2.98	7.00	A++
	2.50	2.50	3.50	5.00	—	1.86	1.86	2.57	3.71	—	3.20	10.00	11.00	0.55	3.33	4.10	2.44	14.77	18.19	3.00	7.00	A++
	2.50	2.50	4.20	4.20	—	1.86	1.86	3.14	3.14	—	3.20	10.00	11.00	0.55	3.33	4.10	2.44	14.77	18.19	3.00	7.00	A++
	2.50	2.50	4.20	5.00	—	1.76	1.76	2.97	3.51	—	3.20	10.00	11.00	0.55	3.33	4.10	2.44	14.77	18.19	3.00	7.00	A++
2.50	2.50	5.00	5.00	—	1.67	1.67	3.33	3.33	—	3.20	10.00	11.00	0.55	3.33	4.10	2.44	14.77	18.19	3.00	7.00	A++	
2.50	3.50	3.50	3.50	—	1.94	2.69	2.69	2.69	—	3.20	10.00	11.00	0.55	3.33	4.10	2.44	14.77	18.19	3.00	7.00	A++	
2.50	3.50	3.50	4.20	—	1.83	2.54	2.54	3.10	—	3.20	10.00	11.00	0.55	3.33	4.10	2.44	14.77	18.19	3.00	7.00	A++	
2.50	3.50	3.50	5.00	—	1.73	2.40	2.40	3.47	—	3.20	10.00	11.00	0.55	3.33	4.10	2.44	14.77	18.19	3.00	7.00	A++	
2.50	3.50	4.20	4.20	—	1.73	2.40	2.93	2.93	—	3.20	10.00	11.00	0.55	3.33	4.10	2.44	14.77	18.19	3.00	7.00	A++	
3.50	3.50	3.50	3.50	—	2.50	2.50	2.50	2.50	—	3.20	10.00	11.00	0.55	3.33	4.10	2.44	14.77	18.19	3.00	7.00	A++	
3.50	3.50	3.50	4.20	—	2.37	2.37	2.37	2.89	—	3.20	10.00	11.00	0.55	3.33	4.10	2.44	14.77	18.19	3.00	7.00	A++	
5	2.00	2.00	2.00	2.00	2.00	2.00	2.00	2.00	2.00	2.00	3.20	10.00	11.00	0.55	3.33	4.10	2.44	14.77	18.19	3.00	7.00	A++
	2.00	2.00	2.00	2.00	2.50	1.89	1.89	1.89	1.89	2.45	3.20	10.00	11.00	0.55	3.33	4.10	2.44	14.77	18.19	3.00	7.00	A++
	2.00	2.00	2.00	2.00	3.50	1.72	1.72	1.72	1.72	3.10	3.20	10.00	11.00	0.55	3.33	4.10	2.44	14.77	18.19	3.00	7.00	A++
	2.00	2.00	2.00	2.00	4.20	1.61	1.61	1.61	1.61	3.55	3.20	10.00	11.00	0.55	3.33	4.10	2.44	14.77	18.19	3.00	7.00	A++
	2.00	2.00	2.00	2.00	5.00	1.52	1.52	1.52	1.52	3.94	3.20	10.00	11.00	0.55	3.33	4.10	2.44	14.77	18.19	3.00	7.00	A++
	2.00	2.00	2.00	2.50	2.50	1.79	1.79	1.79	2.32	2.32	3.20	10.00	11.00	0.55	3.33	4.10	2.44	14.77	18.19	3.00	7.00	A++
	2.00	2.00	2.00	2.50	3.50	1.64	1.64	1.64	2.13	2.95	3.20	10.00	11.00	0.55	3.33	4.10	2.44	14.77	18.19	3.00	7.00	A++
	2.00	2.00	2.00	2.50	4.20	1.54	1.54	1.54	2.00	3.38	3.20	10.00	11.00	0.55	3.33	4.10	2.44	14.77	18.19	3.00		

MULTISPLIT COMBINATIONS TABLE

5U105S2SS5FA Inverter (The values in the table refer to the FLEXIS series)

HEATING																						
Combinations					Output power (kW)					System output power (kW)			Absorbed power (kW)			Absorbed current (A)			COP	SCOP	Energy class	
UI	A	B	C	D	E	A	B	C	D	E	min	nom	max	min	nom	max	min	nom	max			
2	2.00	2.00	—	—	—	2.30	2.30	—	—	—	2.80	4.60	8.00	0.55	1.30	3.30	2.44	5.77	14.64	3.54	3.75	A
	2.00	2.50	—	—	—	2.30	3.60	—	—	—	3.00	5.90	10.00	0.55	1.66	3.30	2.44	7.36	14.64	3.55	3.75	A
	2.00	3.50	—	—	—	2.30	4.50	—	—	—	3.20	6.80	10.00	0.55	1.90	3.30	2.44	8.43	14.64	3.58	3.75	A
	2.00	4.20	—	—	—	2.30	5.40	—	—	—	3.40	7.70	10.00	0.55	2.15	3.30	2.44	9.54	14.64	3.58	3.80	A
	2.00	5.00	—	—	—	2.30	6.00	—	—	—	3.80	8.30	11.50	0.55	2.29	3.30	2.44	10.16	14.64	3.62	3.80	A
	2.00	7.10	—	—	—	2.30	7.00	—	—	—	4.00	9.30	11.50	0.55	2.55	3.30	2.44	11.31	14.64	3.65	3.85	A
	2.50	2.50	—	—	—	3.60	3.60	—	—	—	3.40	7.20	10.50	0.55	2.02	3.30	2.44	8.96	14.64	3.56	3.85	A
	2.50	3.50	—	—	—	3.60	4.50	—	—	—	3.80	8.10	10.50	0.55	2.26	3.30	2.44	10.03	14.64	3.58	3.85	A
	2.50	4.20	—	—	—	3.60	5.40	—	—	—	4.00	9.00	10.50	0.55	2.50	3.30	2.44	11.09	14.64	3.60	3.87	A
	2.50	5.00	—	—	—	3.60	6.00	—	—	—	4.40	9.60	10.50	0.55	2.64	3.30	2.44	11.71	14.64	3.64	3.85	A
	2.50	7.10	—	—	—	3.57	6.93	—	—	—	4.40	10.50	11.00	0.55	2.85	3.30	2.44	12.64	14.64	3.68	3.84	A
	3.50	3.50	—	—	—	4.50	4.50	—	—	—	4.00	9.00	10.50	0.55	2.50	3.30	2.44	11.09	14.64	3.60	3.86	A
	3.50	4.20	—	—	—	4.50	5.40	—	—	—	4.40	9.90	10.50	0.55	2.74	3.30	2.44	12.16	14.64	3.61	3.82	A
	3.50	5.00	—	—	—	4.50	6.00	—	—	—	4.40	10.50	11.50	0.55	2.88	3.30	2.44	12.78	14.64	3.65	3.80	A
	3.50	7.10	—	—	—	4.11	6.39	—	—	—	4.40	10.50	11.50	0.55	2.88	3.30	2.44	12.78	14.64	3.65	3.84	A
	4.20	4.20	—	—	—	5.25	5.25	—	—	—	4.40	10.50	11.50	0.55	2.88	3.30	2.44	12.78	14.64	3.65	3.86	A
	4.20	5.00	—	—	—	4.97	5.53	—	—	—	4.40	10.50	11.50	0.55	2.88	3.30	2.44	12.78	14.64	3.65	3.83	A
	4.20	7.10	—	—	—	4.57	5.93	—	—	—	4.40	10.50	11.50	0.55	2.88	3.30	2.44	12.78	14.64	3.65	3.86	A
	5.00	5.00	—	—	—	5.25	5.25	—	—	—	4.40	10.50	11.50	0.55	2.91	3.30	2.44	12.91	14.64	3.61	3.80	A
	5.00	7.10	—	—	—	4.85	5.65	—	—	—	4.40	9.50	11.50	0.55	2.88	3.30	2.44	12.78	14.64	3.30	3.87	A
7.10	7.10	—	—	—	5.25	5.25	—	—	—	4.40	10.50	11.50	0.55	2.88	3.30	2.44	12.78	14.64	3.65	3.85	A	
3	2.00	2.00	2.00	—	—	2.30	2.30	2.30	—	—	3.80	6.90	11.50	0.55	1.93	3.40	2.44	8.56	15.08	3.58	3.80	A
	2.00	2.00	2.50	—	—	2.30	2.30	3.60	—	—	4.00	8.20	11.50	0.55	2.28	3.40	2.44	10.12	15.08	3.60	3.80	A
	2.00	2.00	3.50	—	—	2.30	2.30	4.50	—	—	4.20	9.10	11.50	0.55	2.50	3.40	2.44	11.09	15.08	3.64	3.80	A
	2.00	2.00	4.20	—	—	2.30	2.30	5.40	—	—	4.40	10.00	11.50	0.55	2.73	3.40	2.44	12.11	15.08	3.66	3.80	A
	2.00	2.00	5.00	—	—	2.28	2.28	5.94	—	—	4.40	10.50	11.50	0.55	2.88	3.40	2.44	12.78	15.08	3.65	3.80	A
	2.00	2.00	7.10	—	—	2.08	2.08	6.34	—	—	4.40	10.50	11.50	0.55	2.88	3.40	2.44	12.78	15.08	3.65	3.80	A
	2.00	2.50	2.50	—	—	2.30	3.60	3.60	—	—	4.40	9.50	11.50	0.55	2.63	3.40	2.44	11.67	15.08	3.61	3.80	A
	2.00	2.50	3.50	—	—	2.30	3.60	4.50	—	—	4.40	10.40	11.50	0.55	2.88	3.40	2.44	12.78	15.08	3.61	3.80	A
	2.00	2.50	4.20	—	—	2.14	3.35	5.02	—	—	4.40	10.50	11.50	0.55	2.88	3.40	2.44	12.78	15.08	3.65	3.80	A
	2.00	2.50	5.00	—	—	2.03	3.18	5.29	—	—	4.40	10.50	11.50	0.55	2.88	3.40	2.44	12.78	15.08	3.65	3.82	A
	2.00	2.50	7.10	—	—	1.87	2.93	5.70	—	—	4.40	10.50	11.50	0.55	2.88	3.40	2.44	12.78	15.08	3.65	3.82	A
	2.00	3.50	3.50	—	—	2.14	4.18	4.18	—	—	4.40	10.50	11.50	0.55	2.88	3.40	2.44	12.78	15.08	3.65	3.82	A
	2.00	3.50	4.20	—	—	1.98	3.87	4.65	—	—	4.40	10.50	11.50	0.55	2.88	3.40	2.44	12.78	15.08	3.65	3.82	A
	2.00	3.50	5.00	—	—	1.89	3.69	4.92	—	—	4.40	10.50	11.50	0.55	2.88	3.40	2.44	12.78	15.08	3.65	3.82	A
	2.00	3.50	7.10	—	—	1.75	3.42	5.33	—	—	4.40	10.50	11.50	0.55	2.86	3.40	2.44	12.69	15.08	3.67	3.82	A
	2.00	4.20	4.20	—	—	1.84	4.33	4.33	—	—	4.40	10.50	11.50	0.55	2.86	3.40	2.44	12.69	15.08	3.67	3.82	A
	2.00	4.20	5.00	—	—	1.76	4.14	4.60	—	—	4.40	10.50	11.50	0.55	2.86	3.40	2.44	12.69	15.08	3.67	3.82	A
	2.00	4.20	7.10	—	—	1.64	3.86	5.00	—	—	4.40	10.50	11.50	0.55	2.86	3.40	2.44	12.69	15.08	3.67	3.87	A
	2.00	5.00	5.00	—	—	1.69	4.41	4.41	—	—	4.40	10.50	11.50	0.55	2.86	3.40	2.44	12.69	15.08	3.67	3.87	A
	2.00	5.00	7.10	—	—	1.58	4.12	4.80	—	—	4.40	10.50	11.50	0.55	2.86	3.40	2.44	12.69	15.08	3.67	3.87	A
	2.50	2.50	2.50	—	—	3.50	3.50	3.50	—	—	4.40	10.50	11.50	0.55	2.85	3.40	2.44	12.64	15.08	3.68	3.87	A
	2.50	2.50	3.50	—	—	3.23	3.23	4.04	—	—	4.40	10.50	11.50	0.55	2.85	3.40	2.44	12.64	15.08	3.68	3.87	A
	2.50	2.50	4.20	—	—	3.00	3.00	4.50	—	—	4.40	10.50	11.50	0.55	2.85	3.40	2.44	12.64	15.08	3.68	3.87	A
	2.50	2.50	5.00	—	—	2.86	2.86	4.77	—	—	4.40	10.50	11.50	0.55	2.85	3.40	2.44	12.64	15.08	3.68	3.87	A
	2.50	2.50	7.10	—	—	2.66	2.66	5.18	—	—	4.40	10.50	11.50	0.55	2.85	3.40	2.44	12.64	15.08	3.68	3.90	A
	2.50	3.50	3.50	—	—	3.00	3.75	3.75	—	—	4.40	10.50	11.50	0.55	2.85	3.40	2.44	12.64	15.08	3.68	3.85	A
	2.50	3.50	4.20	—	—	2.80	3.50	4.20	—	—	4.40	10.50	11.50	0.55	2.85	3.40	2.44	12.64	15.08	3.68	3.85	A
	2.50	3.50	5.00	—	—	2.68	3.35	4.47	—	—	4.40	10.50	11.50	0.55	2.85	3.40	2.44	12.64	15.08	3.68	3.85	A
	2.50	3.50	7.10	—	—	2.50	3.13	4.87	—	—	4.40	10.50	11.50	0.55	2.85	3.40	2.44	12.64	15.08	3.68	3.85	A
	2.50	4.20	4.20	—	—	2.63	3.94	3.94	—	—	4.40	10.50	11.50	0.55	2.85	3.40	2.44	12.64	15.08	3.68	3.85	A
	2.50	4.20	5.00	—	—	2.52	3.78	4.20	—	—	4.40	10.50	11.50	0.55	2.85	3.40	2.44	12.64	15.08	3.68	3.85	A
	2.50	4.20	7.10	—	—	2.36	3.54	4.59	—	—	4.40	10.50	11.50	0.55	2.85	3.40	2.44	12.64	15.08	3.68	3.85	A
	2.50	5.00	5.00	—	—	2.42	4.04	4.04	—	—	4.40	10.50	11.50	0.55	2.85	3.40	2.44	12.64	15.08	3.68	3.85	A
	2.50	5.00	7.10	—	—	2.28	3.80	4.43	—	—	4.40	10.50	11.50	0.55	2.85	3.40	2.44	12.64	15.08	3.68	3.85	A
	3.50	3.50	3.50	—	—	3.50	3.50	3.50	—	—	4.40	10.50	11.50	0.55	2.85	3.40	2.44	12.64	15.08	3.68	3.90	A
	3.50	3.50	4.20	—	—	3.28	3.28	3.94	—	—	4.40	10.50	11.50	0.55	2.85	3.40	2.44	12.64	15.08	3.68	3.90	A
	3.50	3.50	5.00	—	—	3.15	3.15	4.20	—	—	4.40	10.50	11.50	0.55	2.83	3.40	2.44	12.56	15.08	3.71	3.90	A
	3.50	3.50	7.10	—	—	2.95	2.95	4.59	—	—	4.40	10.50	11.50	0.55	2.83	3.40	2.44	12.56	15.08	3.71	3.85	A
	3.50	4.20	4.20	—	—	3.09	3.71	3.71	—	—	4.40	10.50	11.50	0.55	2.83	3.40	2.44	12.56	15.08	3.71	3.90	A
	3.50	4.20	5.00	—	—	2.97	3.57	3.96	—	—	4.40	10.50	11.50	0.55	2.83	3.40	2.44	12.56	15.08	3.71	3.90	A
3.50	5.00	5.00	—	—	2.86	3.82	3.82	—	—	4.40	10.50	11.50	0.55	2.83	3.40	2.44	12.56	15.08	3.71	3.90	A	
4.20	4.20	4.20	—	—	3.50	3.50	3.50	—	—	4.40	10.50	11.50	0.55	2.83	3.40	2.44	12.56	15.08	3.71	3.90	A	
4.20	4.20	5.																				

MULTISPLIT COMBINATIONS TABLE

5U105S2SS5FA Inverter (The values in the table refer to the FLEXIS series)

HEATING																							
Combinations					Output power (kW)					System output power (kW)			Absorbed power (kW)			Absorbed current (A)			COP	SCOP	Energy class		
UI	A	B	C	D	E	A	B	C	D	E	min	nom	max	min	nom	max	min	nom	max	max			
4	2.00	2.00	2.00	2.00	—	2.30	2.30	2.30	2.30	—	4.20	9.20	11.50	0.55	2.55	3.40	2.44	11.31	15.08	3.61	3.85	A	
	2.00	2.00	2.00	2.50	—	2.30	2.30	2.30	3.60	—	4.20	10.50	11.50	0.55	2.84	3.40	2.44	12.60	15.08	3.70	3.85	A	
	2.00	2.00	2.00	3.50	—	2.12	2.12	2.12	4.14	—	4.40	10.50	11.50	0.55	2.84	3.40	2.44	12.60	15.08	3.70	3.85	A	
	2.00	2.00	2.00	4.20	—	1.96	1.96	1.96	4.61	—	4.40	10.50	11.50	0.55	2.84	3.40	2.44	12.60	15.08	3.70	3.85	A	
	2.00	2.00	2.00	5.00	—	1.87	1.87	1.87	4.88	—	4.40	10.50	11.50	0.55	2.84	3.40	2.44	12.60	15.08	3.70	3.85	A	
	2.00	2.00	2.00	7.10	—	1.74	1.74	1.74	5.29	—	4.40	10.50	11.50	0.55	2.84	3.40	2.44	12.60	15.08	3.70	3.85	A	
	2.00	2.00	2.50	2.50	—	2.05	2.05	3.20	3.20	—	4.40	10.50	11.50	0.55	2.84	3.40	2.44	12.60	15.08	3.70	3.85	A	
	2.00	2.00	2.50	3.50	—	1.90	1.90	2.98	3.72	—	4.40	10.50	11.50	0.55	2.83	3.40	2.44	12.56	15.08	3.71	3.85	A	
	2.00	2.00	2.50	4.20	—	1.78	1.78	2.78	4.17	—	4.40	10.50	11.50	0.55	2.83	3.40	2.44	12.56	15.08	3.71	3.90	A	
	2.00	2.00	2.50	5.00	—	1.70	1.70	2.66	4.44	—	4.40	10.50	11.50	0.55	2.83	3.40	2.44	12.56	15.08	3.71	3.90	A	
	2.00	2.00	2.50	7.10	—	1.59	1.59	2.49	4.84	—	4.40	10.50	11.50	0.55	2.83	3.40	2.44	12.56	15.08	3.71	3.90	A	
	2.00	2.00	3.50	3.50	—	1.78	1.78	3.47	3.47	—	4.40	10.50	11.50	0.55	2.83	3.40	2.44	12.56	15.08	3.71	3.90	A	
	2.00	2.00	3.50	4.20	—	1.67	1.67	3.26	3.91	—	4.40	10.50	11.50	0.55	2.83	3.40	2.44	12.56	15.08	3.71	3.90	A	
	2.00	2.00	3.50	5.00	—	1.60	1.60	3.13	4.17	—	4.40	10.50	11.50	0.55	2.81	3.40	2.44	12.47	15.08	3.74	3.90	A	
	2.00	2.00	3.50	7.10	—	1.50	1.50	2.93	4.57	—	4.40	10.50	11.50	0.55	2.81	3.40	2.44	12.47	15.08	3.74	3.90	A	
	2.00	2.00	4.20	4.20	—	1.57	1.57	3.68	3.68	—	4.40	10.50	11.50	0.55	2.81	3.40	2.44	12.47	15.08	3.74	3.90	A	
	2.00	2.00	4.20	5.00	—	1.51	1.51	3.54	3.94	—	4.40	10.50	11.50	0.55	2.81	3.40	2.44	12.47	15.08	3.74	3.90	A	
	2.00	2.00	5.00	5.00	—	1.45	1.45	3.80	3.80	—	4.40	10.50	11.50	0.55	2.81	3.40	2.44	12.47	15.08	3.74	3.90	A	
	2.00	2.50	2.50	2.50	—	1.84	2.89	2.89	2.89	—	4.40	10.50	11.50	0.55	2.81	3.40	2.44	12.47	15.08	3.74	3.90	A	
	2.00	2.50	2.50	3.50	—	1.73	2.70	2.70	3.38	—	4.40	10.50	11.50	0.55	2.80	3.40	2.44	12.42	15.08	3.75	3.90	A	
	2.00	2.50	2.50	4.20	—	1.62	2.54	2.54	3.81	—	4.40	10.50	11.50	0.55	2.80	3.40	2.44	12.42	15.08	3.75	3.95	A	
	2.00	2.50	2.50	5.00	—	1.56	2.44	2.44	4.06	—	4.40	10.50	11.50	0.55	2.80	3.40	2.44	12.42	15.08	3.75	3.95	A	
	2.00	2.50	2.50	7.10	—	1.46	2.29	2.29	4.45	—	4.40	10.50	11.50	0.55	2.80	3.40	2.44	12.42	15.08	3.75	3.95	A	
	2.00	2.50	3.50	3.50	—	1.62	2.54	3.17	3.17	—	4.40	10.50	11.50	0.55	2.80	3.40	2.44	12.42	15.08	3.75	3.95	A	
	2.00	2.50	3.50	4.20	—	1.53	2.39	2.99	3.59	—	4.40	10.50	11.50	0.55	2.80	3.40	2.44	12.42	15.08	3.75	3.95	A	
	2.00	2.50	3.50	5.00	—	1.47	2.30	2.88	3.84	—	4.40	10.50	11.50	0.55	2.80	3.40	2.44	12.42	15.08	3.75	3.95	A	
	2.00	2.50	4.20	4.20	—	1.45	2.26	3.40	3.40	—	4.40	10.50	11.50	0.55	2.80	3.40	2.44	12.42	15.08	3.75	3.95	A	
	2.00	2.50	4.20	5.00	—	1.40	2.18	3.28	3.64	—	4.40	10.50	11.50	0.55	2.80	3.40	2.44	12.42	15.08	3.75	3.95	A	
	2.00	2.50	5.00	5.00	—	1.35	2.11	3.52	3.52	—	4.40	10.50	11.50	0.55	2.78	3.40	2.44	12.33	15.08	3.78	3.95	A	
	2.00	3.50	3.50	3.50	—	1.53	2.99	2.99	2.99	—	4.40	10.50	11.50	0.55	2.78	3.40	2.44	12.33	15.08	3.78	3.95	A	
	2.00	3.50	3.50	4.20	—	1.45	2.83	2.83	3.40	—	4.40	10.50	11.50	0.55	2.78	3.40	2.44	12.33	15.08	3.78	4.00	A+	
	2.00	3.50	3.50	5.00	—	1.40	2.73	2.73	3.64	—	4.40	10.50	11.50	0.55	2.78	3.40	2.44	12.33	15.08	3.78	4.00	A+	
	2.00	3.50	4.20	4.20	—	1.37	2.68	3.22	3.22	—	4.40	10.50	11.50	0.55	2.78	3.40	2.44	12.33	15.08	3.78	4.00	A+	
	2.00	3.50	4.20	5.00	—	1.33	2.60	3.12	3.46	—	4.40	10.50	11.50	0.55	2.78	3.40	2.44	12.33	15.08	3.78	4.00	A+	
	2.00	4.20	4.20	4.20	—	1.31	3.06	3.06	3.06	—	4.40	10.50	11.50	0.55	2.78	3.40	2.44	12.33	15.08	3.78	4.00	A+	
	2.50	2.50	2.50	2.50	—	2.63	2.63	2.63	2.63	—	4.40	10.50	11.50	0.55	2.76	3.40	2.44	12.24	15.08	3.80	4.00	A+	
	2.50	2.50	2.50	3.50	—	2.47	2.47	2.47	3.09	—	4.40	10.50	11.50	0.55	2.76	3.40	2.44	12.24	15.08	3.80	4.00	A+	
	2.50	2.50	2.50	4.20	—	2.33	2.33	2.33	3.50	—	4.40	10.50	11.50	0.55	2.76	3.40	2.44	12.24	15.08	3.80	4.00	A+	
	2.50	2.50	2.50	5.00	—	2.25	2.25	2.25	3.75	—	4.40	10.50	11.50	0.55	2.76	3.40	2.44	12.24	15.08	3.80	4.00	A+	
	2.50	2.50	2.50	7.10	—	2.12	2.12	2.12	4.13	—	4.40	10.50	11.50	0.55	2.76	3.40	2.44	12.24	15.08	3.80	4.00	A+	
2.50	2.50	3.50	3.50	—	2.33	2.33	2.92	2.92	—	4.40	10.50	11.50	0.55	2.76	3.40	2.44	12.24	15.08	3.80	4.00	A+		
2.50	2.50	3.50	4.20	—	2.21	2.21	2.76	3.32	—	4.40	10.50	11.50	0.55	2.76	3.40	2.44	12.24	15.08	3.80	4.00	A+		
2.50	2.50	3.50	5.00	—	2.14	2.14	2.67	3.56	—	4.40	10.50	11.50	0.55	2.76	3.40	2.44	12.24	15.08	3.80	4.00	A+		
2.50	2.50	4.20	4.20	—	2.10	2.10	3.15	3.15	—	4.40	10.50	11.50	0.55	2.76	3.40	2.44	12.24	15.08	3.80	4.00	A+		
2.50	2.50	4.20	5.00	—	2.03	2.03	3.05	3.39	—	4.40	10.50	11.50	0.55	2.76	3.40	2.44	12.24	15.08	3.80	4.00	A+		
2.50	2.50	5.00	5.00	—	1.97	1.97	3.28	3.28	—	4.40	10.50	11.50	0.55	2.76	3.40	2.44	12.24	15.08	3.80	4.00	A+		
2.50	3.50	3.50	3.50	—	2.21	2.76	2.76	2.76	—	4.40	10.50	11.50	0.55	2.76	3.40	2.44	12.24	15.08	3.80	4.00	A+		
2.50	3.50	3.50	4.20	—	2.10	2.63	2.63	3.15	—	4.40	10.50	11.50	0.55	2.76	3.40	2.44	12.24	15.08	3.80	4.00	A+		
2.50	3.50	3.50	5.00	—	2.03	2.54	2.54	3.39	—	4.40	10.50	11.50	0.55	2.76	3.40	2.44	12.24	15.08	3.80	4.00	A+		
2.50	3.50	4.20	4.20	—	2.00	2.50	3.00	3.00	—	4.40	10.50	11.50	0.55	2.76	3.40	2.44	12.24	15.08	3.80	4.00	A+		
3.50	3.50	3.50	3.50	—	2.63	2.63	2.63	2.63	—	4.40	10.50	11.50	0.55	2.76	3.40	2.44	12.24	15.08	3.80	4.00	A+		
3.50	3.50	3.50	4.20	—	2.50	2.50	2.50	3.00	—	4.40	10.50	11.50	0.55	2.76	3.40	2.44	12.24	15.08	3.80	4.00	A+		
5	2.00	2.00	2.00	2.00	2.00	2.10	2.10	2.10	2.10	2.10	4.20	10.50	11.50	0.55	2.76	3.40	2.44	12.24	15.08	3.80	4.00	A+	
	2.00	2.00	2.00	2.00	2.50	1.89	1.89	1.89	1.89	2.95	4.20	10.50	11.50	0.55	2.76	3.40	2.44	12.24	15.08	3.80	4.00	A+	
	2.00	2.00	2.00	2.00	3.50	1.76	1.76	1.76	1.76	3.45	4.20	10.50	11.50	0.55	2.76	3.40	2.44	12.24	15.08	3.80	4.00	A+	
	2.00	2.00	2.00	2.00	4.20	1.65	1.65	1.65	1.65	3.88	4.20	10.50	11.50	0.55	2.76	3.40	2.44	12.24	15.08	3.80	4.00	A+	
	2.00	2.00	2.00	2.00	5.00	1.59	1.59	1.59	1.59	4.14	4.20	10.50	11.50	0.55	2.76	3.40	2.44	12.24	15.08	3.80	4.00	A+	
	2.00	2.00	2.00	2.50	2.50	1.71	1.71	1.71	2.68	2.68	4.20	10.50	11.50	0.55	2.76	3.40	2.44	12.24	15.08	3.80	4.00	A+	
	2.00	2.00	2.00	2.50	3.50	1.61	1.61	1.61	2.52	3.15	4.20	10.50	11.50	0.55	2.76	3.40	2.44	12.24	15.08	3.80	4.00	A+	
	2.00	2.00	2.00	2.50	4.20	1.52	1.52	1.52	2.38	3.57	4.20	10.50	11.50	0.55	2.76	3.40	2.44	12.24	15.08	3.80	4.00	A+	

MULTISPLIT COMBINATIONS TABLE

5U125S2SN1FA Inverter (The values in the table refer to the FLEXIS series)

COOLING																						
Combinations					Output power (kW)					System output power (kW)			Absorbed power (kW)			Absorbed current (A)			EER	SEER	Energy class	
UI	A	B	C	D	E	A	B	C	D	E	min	nom	max	min	nom	max	min	nom	max			
2	2.00	2.00	—	—	—	2.00	2.00	—	—	—	2.50	4.00	5.60	0.55	1.50	3.60	2.44	6.65	15.97	2.97	6.20	A++
	2.00	2.50	—	—	—	2.00	2.60	—	—	—	2.50	4.60	6.70	0.55	1.54	3.60	2.44	6.83	15.97	2.99	6.20	A++
	2.00	3.50	—	—	—	2.00	3.60	—	—	—	2.50	5.60	8.10	0.55	1.86	3.60	2.44	8.25	15.97	3.01	6.20	A++
	2.00	4.20	—	—	—	2.00	4.40	—	—	—	2.50	6.40	7.80	0.55	2.12	3.60	2.44	9.41	15.97	3.02	6.20	A++
	2.00	5.00	—	—	—	2.00	5.20	—	—	—	2.50	7.20	9.30	0.55	2.38	3.60	2.44	10.56	15.97	3.03	6.20	A++
	2.00	7.10	—	—	—	2.00	6.50	—	—	—	2.50	8.50	9.30	0.55	2.80	3.60	2.44	12.42	15.97	3.04	6.20	A++
	2.50	2.50	—	—	—	2.60	2.60	—	—	—	2.50	5.20	7.80	0.55	1.73	3.60	2.44	7.68	15.97	3.01	6.20	A++
	2.50	3.50	—	—	—	2.60	3.60	—	—	—	2.50	6.20	9.10	0.55	2.05	3.60	2.44	9.09	15.97	3.02	6.20	A++
	2.50	4.20	—	—	—	2.60	4.40	—	—	—	2.50	7.00	9.30	0.55	2.31	3.60	2.44	10.25	15.97	3.03	6.20	A++
	2.50	5.00	—	—	—	2.60	5.20	—	—	—	2.50	7.80	9.30	0.55	2.57	3.60	2.44	11.40	15.97	3.04	6.20	A++
	2.50	7.10	—	—	—	2.60	6.50	—	—	—	2.50	9.10	9.30	0.55	2.98	3.60	2.44	13.22	15.97	3.05	6.20	A++
	3.50	3.50	—	—	—	3.60	3.60	—	—	—	2.50	7.20	9.30	0.55	2.38	3.60	2.44	10.56	15.97	3.03	6.20	A++
	3.50	4.20	—	—	—	3.60	4.40	—	—	—	2.50	8.00	9.30	0.55	2.63	3.60	2.44	11.67	15.97	3.04	6.20	A++
	3.50	5.00	—	—	—	3.60	5.20	—	—	—	2.50	8.80	10.00	0.55	2.89	3.60	2.44	12.82	15.97	3.04	6.20	A++
	3.50	7.10	—	—	—	3.60	6.50	—	—	—	2.50	10.10	13.80	0.55	3.31	3.60	2.44	14.69	15.97	3.05	6.20	A++
	4.20	4.20	—	—	—	4.40	4.40	—	—	—	2.50	8.80	10.00	0.55	2.89	3.60	2.44	12.82	15.97	3.04	6.20	A++
	4.20	5.00	—	—	—	4.40	5.20	—	—	—	2.50	9.60	10.50	0.55	3.14	3.60	2.44	13.93	15.97	3.06	6.20	A++
	4.20	7.10	—	—	—	4.40	6.50	—	—	—	2.50	10.90	13.80	0.55	3.55	3.60	2.44	15.75	15.97	3.07	6.20	A++
	5.00	5.00	—	—	—	5.20	5.20	—	—	—	2.50	10.40	13.80	0.55	3.39	3.60	2.44	15.03	15.97	3.07	6.20	A++
	5.00	7.10	—	—	—	5.20	6.50	—	—	—	2.50	11.70	13.80	0.55	3.80	3.60	2.44	16.85	15.97	3.08	6.20	A++
7.10	7.10	—	—	—	6.25	6.25	—	—	—	2.50	12.50	13.80	0.55	4.05	3.60	2.44	17.95	15.97	3.09	6.20	A++	
3	2.00	2.00	2.00	—	—	2.00	2.00	2.00	—	—	3.00	6.00	9.50	0.55	1.98	3.80	2.44	8.78	16.86	3.03	6.70	A++
	2.00	2.00	2.50	—	—	2.00	2.00	2.60	—	—	3.00	6.60	9.50	0.55	2.17	3.80	2.44	9.63	16.86	3.04	6.70	A++
	2.00	2.00	3.50	—	—	2.00	2.00	3.60	—	—	3.00	7.60	9.50	0.55	2.50	3.80	2.44	11.09	16.86	3.04	6.70	A++
	2.00	2.00	4.20	—	—	2.00	2.00	4.40	—	—	3.20	8.40	9.50	0.55	2.76	3.80	2.44	12.26	16.86	3.04	6.70	A++
	2.00	2.00	5.00	—	—	2.00	2.00	5.20	—	—	3.20	9.20	10.00	0.55	3.02	3.80	2.44	13.38	16.86	3.05	6.70	A++
	2.00	2.00	7.10	—	—	2.00	2.00	6.50	—	—	3.20	10.50	13.80	0.55	3.43	5.20	2.44	15.22	23.07	3.06	6.70	A++
	2.00	2.50	2.50	—	—	2.00	2.60	2.60	—	—	3.20	7.20	9.50	0.55	2.38	3.80	2.44	10.56	16.86	3.03	6.70	A++
	2.00	2.50	3.50	—	—	2.00	2.60	3.60	—	—	3.20	8.20	9.50	0.55	2.69	3.80	2.44	11.93	16.86	3.05	6.70	A++
	2.00	2.50	4.20	—	—	2.00	2.60	4.40	—	—	3.20	9.00	10.00	0.55	2.95	3.80	2.44	13.09	16.86	3.05	6.70	A++
	2.00	2.50	5.00	—	—	2.00	2.60	5.20	—	—	3.20	9.80	13.80	0.55	3.20	3.80	2.44	14.21	16.86	3.06	6.70	A++
	2.00	2.50	7.10	—	—	2.00	2.60	6.50	—	—	3.20	11.10	13.80	0.55	3.62	5.20	2.44	16.04	23.07	3.07	6.70	A++
	2.00	3.50	3.50	—	—	2.00	3.60	3.60	—	—	3.20	9.20	13.80	0.55	3.02	3.80	2.44	13.38	16.86	3.05	6.70	A++
	2.00	3.50	4.20	—	—	2.00	3.60	4.40	—	—	3.20	10.00	13.80	0.55	3.26	5.20	2.44	14.45	23.07	3.07	6.70	A++
	2.00	3.50	5.00	—	—	2.00	3.60	5.20	—	—	3.20	10.80	13.80	0.55	3.50	5.20	2.44	15.51	23.07	3.09	6.70	A++
	2.00	3.50	7.10	—	—	2.00	3.60	6.50	—	—	3.20	12.10	13.80	0.55	3.92	5.20	2.44	17.37	23.07	3.09	6.70	A++
	2.00	4.20	4.20	—	—	2.00	4.40	4.40	—	—	3.20	10.80	13.80	0.55	3.50	5.20	2.44	15.51	23.07	3.09	6.70	A++
	2.00	4.20	5.00	—	—	2.00	4.40	5.20	—	—	3.20	11.60	13.80	0.55	3.75	5.20	2.44	16.65	23.07	3.09	6.70	A++
	2.00	4.20	7.10	—	—	1.94	4.26	6.30	—	—	3.20	12.50	13.80	0.55	4.04	5.20	2.44	17.92	23.07	3.09	6.70	A++
	2.00	5.00	5.00	—	—	2.00	5.20	5.20	—	—	3.20	12.40	13.80	0.55	4.01	5.20	2.44	17.79	23.07	3.09	6.70	A++
	2.00	5.00	7.10	—	—	1.82	4.74	5.93	—	—	3.20	12.50	13.80	0.55	4.04	4.10	2.44	17.92	18.19	3.09	6.70	A++
	2.50	2.50	2.50	—	—	2.60	2.60	2.60	—	—	3.20	7.80	9.50	0.55	2.57	3.80	2.44	11.38	16.86	3.04	6.72	A++
	2.50	2.50	3.50	—	—	2.60	2.60	3.60	—	—	3.20	8.80	10.00	0.55	2.89	3.80	2.44	12.80	16.86	3.05	6.72	A++
	2.50	2.50	4.20	—	—	2.60	2.60	4.40	—	—	3.20	9.60	13.80	0.55	3.14	3.80	2.44	13.92	16.86	3.06	6.74	A++
	2.50	2.50	5.00	—	—	2.60	2.60	5.20	—	—	3.20	10.40	13.80	0.55	3.37	5.20	2.44	14.93	23.07	3.09	6.74	A++
	2.50	2.50	7.10	—	—	2.60	2.60	6.50	—	—	3.20	11.70	13.80	0.55	3.79	5.20	2.44	16.80	23.07	3.09	6.70	A++
	2.50	3.50	3.50	—	—	2.60	3.60	3.60	—	—	3.20	9.80	13.80	0.55	3.19	3.80	2.44	14.16	16.86	3.07	6.73	A++
	2.50	3.50	4.20	—	—	2.60	3.60	4.40	—	—	3.20	10.60	13.80	0.55	3.43	5.20	2.44	15.22	23.07	3.09	6.70	A++
	2.50	3.50	5.00	—	—	2.60	3.60	5.20	—	—	3.20	11.40	13.80	0.55	3.69	5.20	2.44	16.37	23.07	3.09	6.70	A++
	2.50	3.50	7.10	—	—	2.56	3.54	6.40	—	—	3.20	12.50	13.80	0.55	4.04	5.20	2.44	17.92	23.07	3.09	6.70	A++
	2.50	4.20	4.20	—	—	2.60	4.40	4.40	—	—	3.20	11.40	13.80	0.55	3.69	5.20	2.44	16.37	23.07	3.09	6.70	A++
	2.50	4.20	5.00	—	—	2.60	4.40	5.20	—	—	3.20	12.20	13.80	0.55	3.95	5.20	2.44	17.52	23.07	3.09	6.70	A++
	2.50	4.20	7.10	—	—	2.41	4.07	6.02	—	—	3.20	12.50	13.80	0.55	4.04	5.20	2.44	17.92	23.07	3.09	6.70	A++
	2.50	5.00	5.00	—	—	2.50	5.00	5.00	—	—	3.20	12.50	13.80	0.55	4.04	5.20	2.44	17.92	23.07	3.09	6.70	A++
	2.50	5.00	7.10	—	—	2.27	4.55	5.68	—	—	3.20	12.50	13.80	0.55	4.04	5.20	2.44	17.92	23.07	3.09	6.70	A++
	2.50	7.10	7.10	—	—	2.08	5.21	5.21	—	—	3.20	12.50	13.80	0.55	4.04	5.20	2.44	17.92	23.07	3.09	6.70	A++
	3.50	3.50	3.50	—	—	3.60	3.60	3.60	—	—	3.20	10.80	13.80	0.55	3.50	5.20	2.44	15.51	23.07	3.09	6.75	A++
	3.50	3.50	4.20	—	—	3.60	3.60	4.40	—	—	3.20	11.60	13.80	0.55	3.75	5.20	2.44	16.65	23.07	3.09	6.70	A++
	3.50	3.50	5.00	—	—	3.60	3.60	5.20	—	—	3.20	12.40	13.80	0.55	3.96	5.20	2.44	17.57	23.07	3.13	6.70	A++
	3.50	3.50	7.10	—	—	3.28	3.28	5.93	—	—	3.20	12.50	13.80	0.55	3.99	5.20	2.44	17.70	23.07	3.13	6.70	A++
	3.50	4.20	4.20	—	—	3.60	4.40	4.40	—	—	3.20	12.40	13.80	0.55	3.96	5.20	2.44	17.57	23.07	3.13	6.75	A++
3.50	4.20	5.00	—	—	3.41	4.17	4.92	—	—	3.20	12.50	13.80	0.55	3.99	5.20	2.44	17.70	23.07	3.13	6.75	A++	
3.50	4.20	7.10	—	—	3.10	3.79	5.60	—	—	3.20	12.50	13.80	0.55	3.99	5.20	2.44	17.70	23.07	3.13	6.75		

MULTISPLIT COMBINATIONS TABLE

5U125S2SN1FA Inverter (The values in the table refer to the FLEXIS series)

COOLING																						
Combinations					Output power (kW)					System output power (kW)			Absorbed power (kW)			Absorbed current (A)			EER	SEER	Energy class	
UI	A	B	C	D	E	A	B	C	D	E	min	nom	max	min	nom	max	min	nom	max			
2.00	2.00	2.00	2.00	2.00	—	2.00	2.00	2.00	2.00	—	3.20	8.00	13.80	0.55	2.62	4.00	2.44	11.63	17.75	3.05	6.80	A++
2.00	2.00	2.00	2.00	2.50	—	2.00	2.00	2.00	2.60	—	3.20	8.60	13.80	0.55	2.81	4.00	2.44	12.47	17.75	3.06	6.80	A++
2.00	2.00	2.00	2.00	3.50	—	2.00	2.00	2.00	3.60	—	3.20	9.60	13.80	0.55	3.13	4.00	2.44	13.87	17.75	3.07	6.80	A++
2.00	2.00	2.00	2.00	4.20	—	2.00	2.00	2.00	4.40	—	3.20	10.40	13.80	0.55	3.32	5.20	2.44	14.74	23.07	3.13	6.80	A++
2.00	2.00	2.00	2.00	5.00	—	2.00	2.00	2.00	5.20	—	3.20	11.20	13.80	0.55	3.58	5.20	2.44	15.87	23.07	3.13	6.80	A++
2.00	2.00	2.00	2.00	7.10	—	2.00	2.00	2.00	6.50	—	3.20	12.50	13.80	0.55	3.99	4.10	2.44	17.70	18.19	3.13	6.70	A++
2.00	2.00	2.50	2.50	2.50	—	2.00	2.00	2.60	2.60	—	3.20	9.20	13.80	0.55	3.00	4.00	2.44	13.29	17.75	3.07	6.80	A++
2.00	2.00	2.50	2.50	3.50	—	2.00	2.00	2.60	3.60	—	3.20	10.20	13.80	0.55	3.25	5.20	2.44	14.41	23.07	3.14	6.80	A++
2.00	2.00	2.50	2.50	4.20	—	2.00	2.00	2.60	4.40	—	3.20	11.00	13.80	0.55	3.47	5.20	2.44	15.39	23.07	3.17	6.80	A++
2.00	2.00	2.50	2.50	5.00	—	2.00	2.00	2.60	5.20	—	3.20	11.80	13.80	0.55	3.72	5.20	2.44	16.51	23.07	3.17	6.80	A++
2.00	2.00	2.50	2.50	7.10	—	1.91	1.91	2.48	6.20	—	3.20	12.50	13.80	0.55	3.94	5.20	2.44	17.48	23.07	3.17	6.70	A++
2.00	2.00	3.50	3.50	3.50	—	2.00	2.00	3.60	3.60	—	3.20	11.20	13.80	0.55	3.53	5.20	2.44	15.67	23.07	3.17	6.80	A++
2.00	2.00	3.50	4.20	4.20	—	2.00	2.00	3.60	4.40	—	3.20	12.00	13.80	0.55	3.79	5.20	2.44	16.79	23.07	3.17	6.70	A++
2.00	2.00	3.50	5.00	5.00	—	1.95	1.95	3.52	5.08	—	3.20	12.50	13.80	0.55	3.94	5.20	2.44	17.48	23.07	3.17	6.70	A++
2.00	2.00	3.50	7.10	7.10	—	1.77	1.77	3.19	5.76	—	3.20	12.50	13.80	0.55	3.94	5.20	2.44	17.48	23.07	3.17	6.70	A++
2.00	2.00	4.20	4.20	4.20	—	1.95	1.95	4.30	4.30	—	3.20	12.50	13.80	0.55	3.94	5.20	2.44	17.48	23.07	3.17	6.90	A++
2.00	2.00	4.20	5.00	5.00	—	1.84	1.84	4.04	4.78	—	3.20	12.50	13.80	0.55	3.94	5.20	2.44	17.48	23.07	3.17	6.90	A++
2.00	2.00	4.20	7.10	7.10	—	1.68	1.68	3.69	5.45	—	3.20	12.50	13.80	0.55	3.94	5.20	2.44	17.48	23.07	3.17	6.90	A++
2.00	2.00	5.00	5.00	5.00	—	1.74	1.74	4.51	4.51	—	3.20	12.50	13.80	0.55	3.94	5.20	2.44	17.48	23.07	3.17	6.90	A++
2.00	2.00	5.00	7.10	7.10	—	1.59	1.59	4.14	5.18	—	3.20	12.50	13.80	0.55	3.94	5.20	2.44	17.48	23.07	3.17	6.90	A++
2.00	2.00	7.10	7.10	7.10	—	1.47	1.47	4.78	4.78	—	3.20	12.50	13.80	0.55	3.94	5.20	2.44	17.48	23.07	3.17	6.90	A++
2.00	2.50	2.50	2.50	2.50	—	2.00	2.60	2.60	2.60	—	3.20	9.80	13.80	0.55	3.17	4.00	2.44	14.07	17.75	3.09	6.90	A++
2.00	2.50	2.50	2.50	3.50	—	2.00	2.60	2.60	3.60	—	3.20	10.80	13.80	0.55	3.41	5.20	2.44	15.11	23.07	3.17	6.90	A++
2.00	2.50	2.50	2.50	4.20	—	2.00	2.60	2.60	4.40	—	3.20	11.60	13.80	0.55	3.66	5.20	2.44	16.23	23.07	3.17	6.90	A++
2.00	2.50	2.50	2.50	5.00	—	2.00	2.60	2.60	5.20	—	3.20	12.40	13.80	0.55	3.91	5.20	2.44	17.35	23.07	3.17	6.90	A++
2.00	2.50	2.50	2.50	7.10	—	1.82	2.37	2.57	5.93	—	3.20	12.50	13.80	0.55	3.94	5.20	2.44	17.48	23.07	3.17	6.90	A++
2.00	2.50	3.50	3.50	3.50	—	2.00	2.60	3.60	3.60	—	3.20	11.80	13.80	0.55	3.70	5.20	2.44	16.41	23.07	3.19	6.90	A++
2.00	2.50	3.50	4.20	4.20	—	1.98	2.58	3.57	4.37	—	3.20	12.50	13.80	0.55	3.92	5.20	2.44	17.39	23.07	3.19	6.90	A++
2.00	2.50	3.50	5.00	5.00	—	1.87	2.43	3.36	4.85	—	3.20	12.50	13.80	0.55	3.92	5.20	2.44	17.39	23.07	3.19	6.90	A++
2.00	2.50	3.50	7.10	7.10	—	1.70	2.21	3.06	5.53	—	3.20	12.50	13.80	0.55	3.92	5.20	2.44	17.39	23.07	3.19	6.90	A++
2.00	2.50	4.20	4.20	4.20	—	1.87	2.43	4.10	4.10	—	3.20	12.50	13.80	0.55	3.92	5.20	2.44	17.39	23.07	3.19	6.90	A++
2.00	2.50	4.20	5.00	5.00	—	1.76	2.29	3.87	4.58	—	3.20	12.50	13.80	0.55	3.92	5.20	2.44	17.39	23.07	3.19	6.90	A++
2.00	2.50	4.20	7.10	7.10	—	1.61	2.10	3.55	5.24	—	3.20	12.50	13.80	0.55	3.92	5.20	2.44	17.39	23.07	3.19	6.90	A++
2.00	2.50	5.00	5.00	5.00	—	1.67	2.17	4.33	4.33	—	3.20	12.50	13.80	0.55	3.92	5.20	2.44	17.39	23.07	3.19	6.90	A++
2.00	2.50	5.00	7.10	7.10	—	1.53	1.99	3.99	4.98	—	3.20	12.50	13.80	0.55	3.92	5.20	2.44	17.39	23.07	3.19	6.90	A++
2.00	2.50	7.10	7.10	7.10	—	1.42	1.85	4.62	4.62	—	3.20	12.50	13.80	0.55	3.92	5.20	2.44	17.39	23.07	3.19	6.90	A++
2.00	3.50	3.50	3.50	3.50	—	1.95	3.52	3.52	3.52	—	3.20	12.50	13.80	0.55	3.92	5.20	2.44	17.39	23.07	3.19	6.90	A++
2.00	3.50	3.50	4.20	4.20	—	1.84	3.31	3.31	4.04	—	3.20	12.50	13.80	0.55	3.92	5.20	2.44	17.39	23.07	3.19	6.90	A++
2.00	3.50	3.50	5.00	5.00	—	1.74	3.13	3.13	4.51	—	3.20	12.50	13.80	0.55	3.90	5.20	2.44	17.30	23.07	3.21	6.90	A++
2.00	3.50	3.50	7.10	7.10	—	1.59	2.87	2.87	5.18	—	3.20	12.50	13.80	0.55	3.90	5.20	2.44	17.30	23.07	3.21	6.90	A++
2.00	3.50	4.20	4.20	4.20	—	1.74	3.13	3.82	3.82	—	3.20	12.50	13.80	0.55	3.90	5.20	2.44	17.30	23.07	3.21	6.90	A++
2.00	3.50	4.20	5.00	5.00	—	1.64	2.96	3.62	4.28	—	3.20	12.50	13.80	0.55	3.90	5.20	2.44	17.30	23.07	3.21	6.90	A++
2.00	3.50	4.20	7.10	7.10	—	1.52	2.73	3.53	4.92	—	3.20	12.50	13.80	0.55	3.90	5.20	2.44	17.30	23.07	3.21	6.90	A++
2.00	4.20	4.20	4.20	4.20	—	1.64	3.62	3.62	3.62	—	3.20	12.50	13.80	0.55	3.90	5.20	2.44	17.30	23.07	3.21	6.90	A++
2.00	4.20	4.20	5.00	5.00	—	1.56	3.44	3.44	4.06	—	3.20	12.50	13.80	0.55	3.90	5.20	2.44	17.30	23.07	3.21	6.90	A++
2.00	4.20	4.20	7.10	7.10	—	1.45	3.18	3.18	4.70	—	3.20	12.50	13.80	0.55	3.90	5.20	2.44	17.30	23.07	3.21	6.90	A++
2.00	5.00	5.00	5.00	5.00	—	1.42	3.69	3.69	3.69	—	3.20	12.50	13.80	0.55	3.90	5.20	2.44	17.30	23.07	3.21	6.90	A++
2.50	2.50	2.50	2.50	2.50	—	2.60	2.60	2.60	2.60	—	3.20	10.40	13.80	0.55	3.24	5.20	2.44	14.37	23.07	3.21	6.90	A++
2.50	2.50	2.50	2.50	3.50	—	2.60	2.60	2.60	3.60	—	3.20	11.40	13.80	0.55	3.55	5.20	2.44	15.75	23.07	3.21	6.90	A++
2.50	2.50	2.50	2.50	4.20	—	2.60	2.60	2.60	4.40	—	3.20	12.20	13.80	0.55	3.80	5.20	2.44	16.86	23.07	3.21	6.90	A++
2.50	2.50	2.50	2.50	5.00	—	2.50	2.50	2.50	5.00	—	3.20	12.50	13.80	0.55	3.90	5.20	2.44	17.30	23.07	3.21	6.90	A++
2.50	2.50	2.50	2.50	7.10	—	2.27	2.27	2.27	5.68	—	3.20	12.50	13.80	0.55	3.90	5.20	2.44	17.30	23.07	3.21	6.90	A++
2.50	2.50	2.50	3.50	3.50	—	2.60	2.60	3.60	3.60	—	3.20	12.40	13.80	0.55	3.86	5.20	2.44	17.13	23.07	3.21	6.90	A++
2.50	2.50	3.50	4.20	4.20	—	2.46	2.46	3.41	4.17	—	3.20	12.50	13.80	0.55	3.90	5.20	2.44	17.30	23.07	3.21	7.10	A++
2.50	2.50	3.50	5.00	5.00	—	2.32	2.32	3.21	4.64	—	3.20	12.50	13.80	0.55	3.90	5.20	2.44	17.30	23.07	3.21	7.10	A++
2.50	2.50	3.50	7.10	7.10	—	2.12	2.12	2.94	5.31	—	3.20	12.50	13.80	0.55	3.90	5.20	2.44	17.30	23.07	3.21	7.10	A++
2.50	2.50	4.20	4.20	4.20	—	2.32	2.32	3.93	3.93	—	3.20	12.50	13.80	0.55	3.90	5.20	2.44	17.30	23.07	3.21	7.10	A++
2.50	2.50	4.20	5.00	5.00	—	2.20	2.20	3.72	4.39													

MULTISPLIT COMBINATIONS TABLE

5U125S2SN1FA Inverter (The values in the table refer to the FLEXIS series)

COOLING																						
Combinations					Output power (kW)					System output power (kW)			Absorbed power (kW)			Absorbed current (A)			EER	SEER	Energy class	
UI	A	B	C	D	E	A	B	C	D	E	min	nom	max	min	nom	max	min	nom	max			
5	2.00	2.00	2.00	2.00	2.00	2.00	2.00	2.00	2.00	2.00	3.20	10.00	13.80	0.55	3.10	5.20	2.44	13.75	23.07	3.23	7.10	A++
	2.00	2.00	2.00	2.00	2.50	2.00	2.00	2.00	2.00	2.60	3.20	10.60	13.80	0.55	3.28	5.20	2.44	14.56	23.07	3.23	7.10	A++
	2.00	2.00	2.00	2.00	3.50	2.00	2.00	2.00	2.00	3.60	3.20	11.60	13.80	0.55	3.59	5.20	2.44	15.93	23.07	3.23	7.10	A++
	2.00	2.00	2.00	2.00	4.20	2.00	2.00	2.00	2.00	4.40	3.20	12.40	13.80	0.55	3.84	5.20	2.44	17.03	23.07	3.23	7.10	A++
	2.00	2.00	2.00	2.00	5.00	1.89	1.89	1.89	1.89	4.92	3.20	12.50	13.80	0.55	3.87	5.20	2.44	17.17	23.07	3.23	7.10	A++
	2.00	2.00	2.00	2.00	7.10	1.72	1.72	1.72	1.72	5.60	3.20	12.50	13.80	0.55	3.87	5.20	2.44	17.17	23.07	3.23	7.10	A++
	2.00	2.00	2.00	2.50	2.50	2.00	2.00	2.00	2.60	2.60	3.20	11.20	13.80	0.55	3.47	5.20	2.44	15.38	23.07	3.23	7.10	A++
	2.00	2.00	2.00	2.50	3.50	2.00	2.00	2.00	2.60	3.60	3.20	12.20	13.80	0.55	3.78	5.20	2.44	16.76	23.07	3.23	7.10	A++
	2.00	2.00	2.00	2.50	4.20	1.92	1.92	1.92	2.50	4.23	3.20	12.50	13.80	0.55	3.87	5.20	2.44	17.17	23.07	3.23	7.10	A++
	2.00	2.00	2.00	2.50	5.00	1.81	1.81	1.81	2.36	4.71	3.20	12.50	13.80	0.55	3.87	5.20	2.44	17.17	23.07	3.23	7.10	A++
	2.00	2.00	2.00	2.50	7.10	1.66	1.66	1.66	2.15	5.38	3.20	12.50	13.80	0.55	3.87	5.20	2.44	17.17	23.07	3.23	7.10	A++
	2.00	2.00	2.00	3.50	3.50	1.89	1.89	1.89	3.41	3.41	3.20	12.50	13.80	0.55	3.87	5.20	2.44	17.17	23.07	3.23	7.10	A++
	2.00	2.00	2.00	3.50	4.20	1.79	1.79	1.79	3.21	3.93	3.20	12.50	13.80	0.55	3.87	5.20	2.44	17.17	23.07	3.23	7.10	A++
	2.00	2.00	2.00	3.50	5.00	1.69	1.69	1.69	3.04	4.39	3.20	12.50	13.80	0.55	3.87	5.20	2.44	17.17	23.07	3.23	7.10	A++
	2.00	2.00	2.00	3.50	7.10	1.55	1.55	1.55	2.80	5.05	3.20	12.50	13.80	0.55	3.87	5.20	2.44	17.17	23.07	3.23	7.10	A++
	2.00	2.00	2.00	4.20	4.20	1.69	1.69	1.69	3.72	3.72	3.20	12.50	13.80	0.55	3.87	5.20	2.44	17.17	23.07	3.23	7.10	A++
	2.00	2.00	2.00	4.20	5.00	1.60	1.60	1.60	3.53	4.17	3.20	12.50	13.80	0.55	3.87	5.20	2.44	17.17	23.07	3.23	7.10	A++
	2.00	2.00	2.00	4.20	7.10	1.48	1.48	1.48	3.25	4.81	3.20	12.50	13.80	0.55	3.87	5.20	2.44	17.17	23.07	3.23	7.10	A++
	2.00	2.00	2.50	2.50	2.50	2.00	2.00	2.60	2.60	2.60	3.20	11.80	13.80	0.55	3.65	5.20	2.44	16.21	23.07	3.23	7.10	A++
	2.00	2.00	2.50	2.50	3.50	1.95	1.95	2.54	2.54	3.52	3.20	12.50	13.80	0.55	3.87	5.20	2.44	17.17	23.07	3.23	7.10	A++
	2.00	2.00	2.50	2.50	4.20	1.84	1.84	2.39	2.39	4.04	3.20	12.50	13.80	0.55	3.87	5.20	2.44	17.17	23.07	3.23	7.10	A++
	2.00	2.00	2.50	2.50	5.00	1.74	1.74	2.26	2.26	4.51	3.20	12.50	13.80	0.55	3.87	5.20	2.44	17.17	23.07	3.23	7.10	A++
	2.00	2.00	2.50	2.50	7.10	1.59	1.59	2.07	2.07	5.18	3.20	12.50	13.80	0.55	3.87	5.20	2.44	17.17	23.07	3.23	7.10	A++
	2.00	2.00	2.50	3.50	3.50	1.81	1.81	2.36	2.36	3.26	3.20	12.50	13.80	0.55	3.87	5.20	2.44	17.17	23.07	3.23	7.10	A++
	2.00	2.00	2.50	3.50	4.20	1.71	1.71	2.23	3.08	3.77	3.20	12.50	13.80	0.55	3.87	5.20	2.44	17.17	23.07	3.23	7.10	A++
	2.00	2.00	2.50	3.50	5.00	1.62	1.62	2.11	2.92	4.22	3.20	12.50	13.80	0.55	3.87	5.20	2.44	17.17	23.07	3.23	7.10	A++
	2.00	2.00	2.50	3.50	7.10	1.50	1.50	1.95	2.69	4.87	3.20	12.50	13.80	0.55	3.87	5.20	2.44	17.17	23.07	3.23	7.10	A++
	2.00	2.00	2.50	4.20	4.20	1.62	1.62	2.11	3.57	3.57	3.20	12.50	13.80	0.55	3.87	5.20	2.44	17.17	23.07	3.23	7.10	A++
	2.00	2.00	2.50	4.20	5.00	1.54	1.54	2.01	3.40	4.01	3.20	12.50	13.80	0.55	3.87	5.20	2.44	17.17	23.07	3.23	7.10	A++
	2.00	2.00	2.50	4.20	7.10	1.43	1.43	1.86	3.14	4.64	3.20	12.50	13.80	0.55	3.87	5.20	2.44	17.17	23.07	3.23	7.10	A++
	2.00	2.00	3.50	3.50	3.50	1.69	1.69	3.04	3.04	3.04	3.20	12.50	13.80	0.55	3.87	5.20	2.44	17.17	23.07	3.23	7.10	A++
	2.00	2.00	3.50	3.50	4.20	1.60	1.60	2.88	2.88	3.53	3.20	12.50	13.80	0.55	3.87	5.20	2.44	17.17	23.07	3.23	7.10	A++
	2.00	2.00	3.50	3.50	5.00	1.52	1.52	2.74	2.74	3.96	3.20	12.50	13.80	0.55	3.87	5.20	2.44	17.17	23.07	3.23	7.10	A++
	2.00	2.00	3.50	3.50	7.10	1.41	1.41	2.54	2.54	4.59	3.20	12.50	13.80	0.55	3.87	5.20	2.44	17.17	23.07	3.23	7.10	A++
	2.00	2.50	2.50	2.50	2.50	2.00	2.60	2.60	2.60	2.60	3.20	12.40	13.80	0.55	3.84	5.20	2.44	17.04	23.07	3.23	7.10	A++
	2.00	2.50	2.50	2.50	3.50	1.87	2.43	2.43	2.43	3.36	3.20	12.50	13.80	0.55	3.87	5.20	2.44	17.17	23.07	3.23	7.10	A++
	2.00	2.50	2.50	2.50	4.20	1.76	2.29	2.29	2.29	3.87	3.20	12.50	13.80	0.55	3.87	5.20	2.44	17.17	23.07	3.23	7.10	A++
	2.00	2.50	2.50	2.50	5.00	1.67	2.17	2.17	2.17	4.33	3.20	12.50	13.80	0.55	3.87	5.20	2.44	17.17	23.07	3.23	7.10	A++
	2.00	2.50	2.50	2.50	7.10	1.53	1.99	1.99	1.99	4.98	3.20	12.50	13.80	0.55	3.87	5.20	2.44	17.17	23.07	3.23	7.10	A++
	2.00	2.50	2.50	3.50	3.50	1.74	2.26	2.26	3.13	3.13	3.20	12.50	13.80	0.55	3.87	5.20	2.44	17.17	23.07	3.23	7.10	A++
	2.00	2.50	2.50	3.50	4.20	1.64	2.14	2.14	2.96	3.62	3.20	12.50	13.80	0.55	3.87	5.20	2.44	17.17	23.07	3.23	7.10	A++
	2.00	2.50	2.50	3.50	5.00	1.56	2.03	2.03	2.81	4.06	3.20	12.50	13.80	0.55	3.87	5.20	2.44	17.17	23.07	3.23	7.10	A++
	2.00	2.50	2.50	3.50	7.10	1.45	1.88	1.88	2.60	4.70	3.20	12.50	13.80	0.55	3.87	5.20	2.44	17.17	23.07	3.23	7.10	A++
	2.00	2.50	3.50	3.50	3.50	1.62	2.11	2.92	2.92	2.92	3.20	12.50	13.80	0.55	3.87	5.20	2.44	17.17	23.07	3.23	7.10	A++
	2.00	2.50	3.50	3.50	4.20	1.54	2.01	2.78	2.78	3.40	3.20	12.50	13.80	0.55	3.87	5.20	2.44	17.17	23.07	3.23	7.10	A++
	2.00	2.50	3.50	3.50	5.00	1.47	1.91	2.65	2.65	3.82	3.20	12.50	13.80	0.55	3.87	5.20	2.44	17.17	23.07	3.23	7.10	A++
	2.00	2.50	3.50	3.50	7.10	1.37	1.78	2.46	2.46	4.44	3.20	12.50	13.80	0.55	3.87	5.20	2.44	17.17	23.07	3.23	7.10	A++
	2.50	2.50	2.50	2.50	2.50	2.50	2.50	2.50	2.50	2.50	3.20	12.50	13.80	0.55	3.87	5.20	2.44	17.17	23.07	3.23	7.10	A++
	2.50	2.50	2.50	2.50	3.50	2.32	2.32	2.32	2.32	3.21	3.20	12.50	13.80	0.55	3.87	5.20	2.44	17.17	23.07	3.23	7.10	A++
	2.50	2.50	2.50	2.50	4.20	2.20	2.20	2.20	2.20	3.72	3.20	12.50	13.80	0.55	3.87	5.20	2.44	17.17	23.07	3.23	7.10	A++
	2.50	2.50	2.50	2.50	5.00	2.08	2.08	2.08	2.08	4.17	3.20	12.50	13.80	0.55	3.87	5.20	2.44	17.17	23.07	3.23	7.10	A++
	2.50	2.50	2.50	2.50	7.10	1.92	1.92	1.92	1.92	4.81	3.20	12.50	13.80	0.55	3.87	5.20	2.44	17.17	23.07	3.23	7.10	A++
	2.50	2.50	2.50	3.50	3.50	2.17	2.17	2.17	3.00	3.00	3.20	12.50	13.80	0.55	3.87	5.20	2.44	17.17	23.07	3.23	7.10	A++
	2.50	2.50	2.50	3.50	4.20	2.06	2.06	2.06	2.85	3.48	3.20	12.50	13.80	0.55	3.87	5.20	2.44	17.17	23.07	3.23	7.10	A++
	2.50	2.50	2.50	3.50	5.00	1.96	1.96	1.96	2.71	3.92	3.20	12.50	13.80	0.55	3.87	5.20	2.44	17.17	23.07	3.23	7.10	A++
	2.50	2.50	2.50	3.50	7.10	1.82	1.82	1.82	2.51	4.54	3.20	12.50	13.80	0.55	3.87	5.20	2.44	17.17	23.07	3.23	7.10	A++
	2.50	2.50	2.50	4.20	4.20	1.96	1.96	1.96	3.31	3.31	3.20	12.50	13.80	0.55	3.87	5.20	2.44	17.17	23.07	3.23	7.10	A++
	2.50	2.50	2.50	4.20	5.00																	

MULTISPLIT COMBINATIONS TABLE

5U125S2SN1FA Inverter (The values in the table refer to the FLEXIS series)

HEATING																						
Combinations					Output power (kW)					System output power (kW)			Absorbed power (kW)			Absorbed current (A)			COP	SCOP	Energy class	
UI	A	B	C	D	E	A	B	C	D	E	min	nom	max	min	nom	max	min	nom	max			
2	2.00	2.00	—	—	—	2.30	2.30	—	—	—	2.80	4.60	10.00	0.55	1.33	4.10	2.44	5.88	18.19	3.47	3.80	A
	2.00	2.50	—	—	—	2.30	3.60	—	—	—	3.00	5.90	12.40	0.55	1.70	4.10	2.44	7.52	18.19	3.48	3.80	A
	2.00	3.50	—	—	—	2.30	4.50	—	—	—	3.20	6.80	12.40	0.55	1.94	4.10	2.44	8.59	18.19	3.51	3.80	A
	2.00	4.20	—	—	—	2.30	5.40	—	—	—	3.40	7.70	12.40	0.55	2.19	4.10	2.44	9.73	18.19	3.51	3.85	A
	2.00	5.00	—	—	—	2.30	6.00	—	—	—	3.80	8.30	14.30	0.55	2.34	4.10	2.44	10.37	18.19	3.55	3.85	A
	2.00	7.10	—	—	—	2.30	7.00	—	—	—	4.00	9.30	14.30	0.55	2.60	4.10	2.44	11.52	18.19	3.58	3.90	A
	2.50	2.50	—	—	—	3.60	3.60	—	—	—	3.40	7.20	13.00	0.55	2.06	4.10	2.44	9.15	18.19	3.49	3.90	A
	2.50	3.50	—	—	—	3.60	4.50	—	—	—	3.80	8.10	13.00	0.55	2.31	4.10	2.44	10.24	18.19	3.51	3.88	A
	2.50	4.20	—	—	—	3.60	5.40	—	—	—	4.00	9.00	13.00	0.55	2.55	4.10	2.44	11.31	18.19	3.53	3.92	A
	2.50	5.00	—	—	—	3.60	6.00	—	—	—	4.40	9.60	13.00	0.55	2.69	4.10	2.44	11.93	18.19	3.57	3.90	A
	2.50	7.10	—	—	—	3.60	7.00	—	—	—	4.40	10.60	13.50	0.55	2.94	4.10	2.44	13.03	18.19	3.61	3.89	A
	3.50	3.50	—	—	—	4.50	4.50	—	—	—	4.00	9.00	13.00	0.55	2.55	4.10	2.44	11.31	18.19	3.53	3.91	A
	3.50	4.20	—	—	—	4.50	5.40	—	—	—	4.40	9.90	13.00	0.55	2.79	4.10	2.44	12.37	18.19	3.55	3.87	A
	3.50	5.00	—	—	—	4.50	6.00	—	—	—	4.40	10.50	14.30	0.55	2.92	4.10	2.44	12.97	18.19	3.59	3.85	A
	3.50	7.10	—	—	—	4.50	7.00	—	—	—	4.40	11.50	14.30	0.55	3.19	4.10	2.44	14.13	18.19	3.61	3.89	A
	4.20	4.20	—	—	—	5.40	5.40	—	—	—	4.40	10.80	14.30	0.55	3.03	4.10	2.44	13.42	18.19	3.57	3.91	A
	4.20	5.00	—	—	—	5.40	6.00	—	—	—	4.40	11.40	14.30	0.55	3.16	4.10	2.44	14.01	18.19	3.61	3.88	A
	4.20	7.10	—	—	—	5.40	7.00	—	—	—	4.40	12.40	14.30	0.55	3.43	4.10	2.44	15.20	18.19	3.62	3.91	A
	5.00	5.00	—	—	—	6.00	6.00	—	—	—	4.40	12.00	14.30	0.55	3.31	4.10	2.44	14.66	18.19	3.63	3.85	A
	5.00	7.10	—	—	—	5.86	6.84	—	—	—	4.40	12.70	14.30	0.55	3.49	4.10	2.44	15.48	18.19	3.64	3.92	A
7.10	7.10	—	—	—	6.35	6.35	—	—	—	4.40	12.70	14.30	0.55	3.48	4.10	2.44	15.43	18.19	3.65	3.90	A	
3	2.00	2.00	2.00	—	—	2.30	2.30	2.30	—	—	3.80	6.90	14.30	0.55	1.98	4.30	2.44	8.79	19.08	3.48	3.80	A
	2.00	2.00	2.50	—	—	2.30	2.30	3.60	—	—	4.00	8.20	14.30	0.55	2.34	4.30	2.44	10.39	19.08	3.50	3.85	A
	2.00	2.00	3.50	—	—	2.30	2.30	4.50	—	—	4.20	9.10	14.30	0.55	2.59	4.30	2.44	11.47	19.08	3.52	3.85	A
	2.00	2.00	4.20	—	—	2.30	2.30	5.40	—	—	4.40	10.00	14.30	0.55	2.81	4.30	2.44	12.46	19.08	3.56	3.85	A
	2.00	2.00	5.00	—	—	2.30	2.30	6.00	—	—	4.40	10.60	14.30	0.55	2.98	4.30	2.44	13.21	19.08	3.56	3.85	A
	2.00	2.00	7.10	—	—	2.30	2.30	7.00	—	—	4.40	11.60	14.30	0.55	3.26	4.30	2.44	14.45	19.08	3.56	3.85	A
	2.00	2.50	2.50	—	—	2.30	3.60	3.60	—	—	4.40	9.50	14.30	0.55	2.70	4.30	2.44	11.97	19.08	3.52	3.85	A
	2.00	2.50	3.50	—	—	2.30	3.60	4.50	—	—	4.40	10.40	14.30	0.55	2.95	4.30	2.44	13.11	19.08	3.52	3.85	A
	2.00	2.50	4.20	—	—	2.30	3.60	5.40	—	—	4.40	11.30	14.30	0.55	3.17	4.30	2.44	14.08	19.08	3.56	3.85	A
	2.00	2.50	5.00	—	—	2.30	3.60	6.00	—	—	4.40	11.90	14.30	0.55	3.34	4.30	2.44	14.83	19.08	3.56	3.87	A
	2.00	2.50	7.10	—	—	2.26	3.54	6.89	—	—	4.40	12.70	14.30	0.55	3.57	4.30	2.44	15.83	19.08	3.56	3.87	A
	2.00	3.50	3.50	—	—	2.30	4.50	4.50	—	—	4.40	11.30	14.30	0.55	3.17	4.30	2.44	14.08	19.08	3.56	3.87	A
	2.00	3.50	4.20	—	—	2.30	4.50	5.40	—	—	4.40	12.20	14.30	0.55	3.43	4.30	2.44	15.20	19.08	3.56	3.87	A
	2.00	3.50	5.00	—	—	2.28	4.46	5.95	—	—	4.40	12.70	14.30	0.55	3.57	4.30	2.44	15.83	19.08	3.56	3.87	A
	2.00	3.50	7.10	—	—	2.12	4.14	6.44	—	—	4.40	12.70	14.30	0.55	3.55	4.30	2.44	15.74	19.08	3.58	3.87	A
	2.00	4.20	4.20	—	—	2.23	5.24	5.24	—	—	4.40	12.70	14.30	0.55	3.55	4.30	2.44	15.74	19.08	3.58	3.87	A
	2.00	4.20	5.00	—	—	2.13	5.01	5.56	—	—	4.40	12.70	14.30	0.55	3.55	4.30	2.44	15.74	19.08	3.58	3.87	A
	2.00	4.20	7.10	—	—	1.99	4.67	6.05	—	—	4.40	12.70	14.30	0.55	3.55	4.30	2.44	15.74	19.08	3.58	3.92	A
	2.00	5.00	5.00	—	—	2.04	5.33	5.33	—	—	4.40	12.70	14.30	0.55	3.55	4.30	2.44	15.74	19.08	3.58	3.92	A
	2.00	5.00	7.10	—	—	1.91	4.98	5.81	—	—	4.40	12.70	14.30	0.55	3.55	4.30	2.44	15.74	19.08	3.58	3.92	A
	2.50	2.50	2.50	—	—	3.60	3.60	3.60	—	—	4.40	10.80	14.30	0.55	3.01	4.30	2.44	13.35	19.08	3.59	3.92	A
	2.50	2.50	3.50	—	—	3.60	3.60	4.50	—	—	4.40	11.70	14.30	0.55	3.26	4.30	2.44	14.46	19.08	3.59	3.92	A
	2.50	2.50	4.20	—	—	3.60	3.60	5.40	—	—	4.40	12.60	14.30	0.55	3.51	4.30	2.44	15.57	19.08	3.59	3.92	A
	2.50	2.50	5.00	—	—	3.46	3.46	5.77	—	—	4.40	12.70	14.30	0.55	3.54	4.30	2.44	15.69	19.08	3.59	3.92	A
	2.50	2.50	7.10	—	—	3.22	3.22	6.26	—	—	4.40	12.70	14.30	0.55	3.54	4.30	2.44	15.69	19.08	3.59	3.95	A
	2.50	3.50	3.50	—	—	3.60	4.50	4.50	—	—	4.40	12.60	14.30	0.55	3.51	4.30	2.44	15.57	19.08	3.59	3.90	A
	2.50	3.50	4.20	—	—	3.39	4.23	5.08	—	—	4.40	12.70	14.30	0.55	3.54	4.30	2.44	15.69	19.08	3.59	3.90	A
	2.50	3.50	5.00	—	—	3.24	4.05	5.40	—	—	4.40	12.70	14.30	0.55	3.54	4.30	2.44	15.69	19.08	3.59	3.90	A
	2.50	3.50	7.10	—	—	3.03	3.78	5.89	—	—	4.40	12.70	14.30	0.55	3.54	4.30	2.44	15.69	19.08	3.59	3.90	A
	2.50	4.20	4.20	—	—	3.18	4.76	4.76	—	—	4.40	12.70	14.30	0.55	3.54	4.30	2.44	15.69	19.08	3.59	3.90	A
	2.50	4.20	5.00	—	—	3.05	4.57	5.08	—	—	4.40	12.70	14.30	0.55	3.54	4.30	2.44	15.69	19.08	3.59	3.90	A
	2.50	4.20	7.10	—	—	2.86	4.29	5.56	—	—	4.40	12.70	14.30	0.55	3.54	4.30	2.44	15.69	19.08	3.59	3.90	A
	2.50	5.00	5.00	—	—	2.93	4.88	4.88	—	—	4.40	12.70	14.30	0.55	3.54	4.30	2.44	15.69	19.08	3.59	3.90	A
	2.50	5.00	7.10	—	—	2.75	4.59	5.36	—	—	4.40	12.70	14.30	0.55	3.54	4.30	2.44	15.69	19.08	3.59	3.90	A
	2.50	7.10	7.10	—	—	2.60	5.05	5.05	—	—	4.40	12.70	14.30	0.55	3.54	4.30	2.44	15.69	19.08	3.59	3.90	A
	3.50	3.50	3.50	—	—	4.23	4.23	4.23	—	—	4.40	12.70	14.30	0.55	3.54	4.30	2.44	15.69	19.08	3.59	3.95	A
	3.50	3.50	4.20	—	—	3.97	3.97	4.76	—	—	4.40	12.70	14.30	0.55	3.54	4.30	2.44	15.69	19.08	3.59	3.95	A
	3.50	3.50	5.00	—	—	3.81	3.81	5.08	—	—	4.40	12.70	14.30	0.55	3.51	4.30	2.44	15.56	19.08	3.62	3.95	A
	3.50	3.50	7.10	—	—	3.57	3.57	5.56	—	—	4.40	12.70	14.30	0.55	3.51	4.30	2.44	15.56	19.08	3.62	3.90	A
	3.50	4.20	4.20	—	—	3.74	4.48	4.48	—	—	4.40	12.70	14.30	0.55	3.51	4.30	2.44	15.56	19.08	3.62	3.95	A
3.50	4.20	5.00	—	—	3.59	4.31	4.79	—	—	4.40	12.70	14.30	0.55	3.51	4.30	2.44	15.56	19.08	3.62	3.95	A	
3.50	4.20	7.10	—	—	3.38	4.06	5.26	—	—	4.40	12.70	14.30	0.55	3.49	4.30	2.44	15.48	19.08	3.64	3.95	A	
3.50																						

MULTISPLIT COMBINATIONS TABLE

5U125S2SN1FA Inverter (The values in the table refer to the FLEXIS series)

HEATING																							
Combinations					Output power (kW)					System output power (kW)			Absorbed power (kW)			Absorbed current (A)			COP	SCOP	Energy class		
UI	A	B	C	D	E	A	B	C	D	E	min	nom	max	min	nom	max	min	nom	max	max			
4	2.00	2.00	2.00	2.00	—	2.30	2.30	2.30	2.30	—	4.20	9.20	14.30	0.55	2.56	4.30	2.44	11.37	19.08	3.59	3.90	A	
	2.00	2.00	2.00	2.50	—	2.30	2.30	2.30	3.60	—	4.20	10.50	14.30	0.55	2.92	4.30	2.44	12.94	19.08	3.60	3.90	A	
	2.00	2.00	2.00	3.50	—	2.30	2.30	2.30	4.50	—	4.40	11.40	14.30	0.55	3.17	4.30	2.44	14.05	19.08	3.60	3.90	A	
	2.00	2.00	2.00	4.20	—	2.30	2.30	2.30	5.40	—	4.40	12.30	14.30	0.55	3.42	4.30	2.44	15.16	19.08	3.60	3.90	A	
	2.00	2.00	2.00	5.00	—	2.26	2.26	2.26	5.91	—	4.40	12.70	14.30	0.55	3.53	4.30	2.44	15.65	19.08	3.60	3.90	A	
	2.00	2.00	2.00	7.10	—	2.10	2.10	2.10	6.40	—	4.40	12.70	14.30	0.55	3.53	4.30	2.44	15.65	19.08	3.60	3.90	A	
	2.00	2.00	2.50	2.50	—	2.30	2.30	3.60	3.60	—	4.40	11.80	14.30	0.55	3.28	4.30	2.44	14.54	19.08	3.60	3.90	A	
	2.00	2.00	2.50	3.50	—	2.30	2.30	3.60	4.50	—	4.40	12.70	14.30	0.55	3.51	4.30	2.44	15.56	19.08	3.62	3.90	A	
	2.00	2.00	2.50	4.20	—	2.15	2.15	3.36	5.04	—	4.40	12.70	14.30	0.55	3.51	4.30	2.44	15.56	19.08	3.62	3.95	A	
	2.00	2.00	2.50	5.00	—	2.06	2.06	3.22	5.37	—	4.40	12.70	14.30	0.55	3.51	4.30	2.44	15.56	19.08	3.62	3.95	A	
	2.00	2.00	2.50	7.10	—	1.92	1.92	3.01	5.85	—	4.40	12.70	14.30	0.55	3.51	4.30	2.44	15.56	19.08	3.62	3.95	A	
	2.00	2.00	3.50	3.50	—	2.15	2.15	4.20	4.20	—	4.40	12.70	14.30	0.55	3.51	4.30	2.44	15.56	19.08	3.62	3.95	A	
	2.00	2.00	3.50	4.20	—	2.01	2.01	3.94	4.73	—	4.40	12.70	14.30	0.55	3.51	4.30	2.44	15.56	19.08	3.62	3.95	A	
	2.00	2.00	3.50	5.00	—	1.93	1.93	3.78	5.05	—	4.40	12.70	14.30	0.55	3.48	4.30	2.44	15.43	19.08	3.65	3.95	A	
	2.00	2.00	3.50	7.10	—	1.81	1.81	3.55	5.52	—	4.40	12.70	14.30	0.55	3.48	4.30	2.44	15.43	19.08	3.65	3.95	A	
	2.00	2.00	4.20	4.20	—	1.90	1.90	4.45	4.45	—	4.40	12.70	14.30	0.55	3.48	4.30	2.44	15.43	19.08	3.65	3.95	A	
	2.00	2.00	4.20	5.00	—	1.83	1.83	4.29	4.76	—	4.40	12.70	14.30	0.55	3.48	4.30	2.44	15.43	19.08	3.65	3.95	A	
	2.00	2.00	4.20	7.10	—	1.72	1.72	4.03	5.23	—	4.40	12.70	14.30	0.55	3.48	4.30	2.44	15.43	19.08	3.65	3.95	A	
	2.00	2.00	5.00	5.00	—	1.76	1.76	4.59	4.59	—	4.40	12.70	14.30	0.55	3.48	4.30	2.44	15.43	19.08	3.65	3.95	A	
	2.00	2.00	5.00	7.10	—	1.66	1.66	4.33	5.05	—	4.40	12.70	14.30	0.55	3.48	4.30	2.44	15.43	19.08	3.65	3.95	A	
	2.00	2.00	7.10	7.10	—	1.57	1.57	4.78	4.78	—	4.40	12.70	14.30	0.55	3.48	4.30	2.44	15.43	19.08	3.65	3.95	A	
	2.00	2.50	2.50	2.50	—	2.23	3.49	3.49	3.49	—	4.40	12.70	14.30	0.55	3.48	4.30	2.44	15.43	19.08	3.65	3.95	A	
	2.00	2.50	2.50	3.50	—	2.09	3.27	3.27	4.08	—	4.40	12.70	14.30	0.55	3.43	4.30	2.44	15.23	19.08	3.70	3.95	A	
	2.00	2.50	2.50	4.20	—	1.96	3.07	3.07	4.60	—	4.40	12.70	14.30	0.55	3.43	4.30	2.44	15.23	19.08	3.70	4.00	A	
	2.00	2.50	2.50	5.00	—	1.88	2.95	2.95	4.92	—	4.40	12.70	14.30	0.55	3.43	4.30	2.44	15.23	19.08	3.70	4.00	A	
	2.00	2.50	2.50	7.10	—	1.77	2.77	2.77	5.39	—	4.40	12.70	14.30	0.55	3.43	4.30	2.44	15.23	19.08	3.70	4.00	A	
	2.00	2.50	3.50	3.50	—	1.96	3.07	3.84	3.84	—	4.40	12.70	14.30	0.55	3.43	4.30	2.44	15.23	19.08	3.70	4.00	A	
	2.00	2.50	3.50	4.20	—	1.85	2.89	3.62	4.34	—	4.40	12.70	14.30	0.55	3.43	4.30	2.44	15.23	19.08	3.70	4.00	A	
	2.00	2.50	3.50	5.00	—	1.78	2.79	3.48	4.65	—	4.40	12.70	14.30	0.55	3.43	4.30	2.44	15.23	19.08	3.70	4.00	A	
	2.00	2.50	3.50	7.10	—	1.68	2.63	3.28	5.11	—	4.40	12.70	14.30	0.55	3.43	4.30	2.44	15.23	19.08	3.70	4.00	A	
	2.00	2.50	4.20	4.20	—	1.75	2.74	4.11	4.11	—	4.40	12.70	14.30	0.55	3.43	4.30	2.44	15.23	19.08	3.70	4.00	A	
	2.00	2.50	4.20	5.00	—	1.69	2.64	3.96	4.40	—	4.40	12.70	14.30	0.55	3.43	4.30	2.44	15.23	19.08	3.70	4.00	A	
	2.00	2.50	4.20	7.10	—	1.60	2.50	3.75	4.86	—	4.40	12.70	14.30	0.55	3.42	4.30	2.44	15.19	19.08	3.71	4.00	A	
	2.00	2.50	5.00	5.00	—	1.63	2.55	4.26	4.26	—	4.40	12.70	14.30	0.55	3.42	4.30	2.44	15.19	19.08	3.71	4.00	A	
	2.00	2.50	5.00	7.10	—	1.55	2.42	4.03	4.70	—	4.40	12.70	14.30	0.55	3.42	4.30	2.44	15.19	19.08	3.71	4.00	A	
	2.00	2.50	7.10	7.10	—	1.47	2.30	4.47	4.47	—	4.40	12.70	14.30	0.55	3.42	4.30	2.44	15.19	19.08	3.71	4.00	A	
	2.00	3.50	3.50	3.50	—	1.85	3.62	3.62	3.62	—	4.40	12.70	14.30	0.55	3.42	4.30	2.44	15.19	19.08	3.71	4.00	A	
	2.00	3.50	3.50	4.20	—	1.75	3.42	3.42	4.11	—	4.40	12.70	14.30	0.55	3.42	4.30	2.44	15.19	19.08	3.71	4.05	A+	
	2.00	3.50	3.50	5.00	—	1.69	3.30	3.30	4.40	—	4.40	12.70	14.30	0.55	3.42	4.30	2.44	15.19	19.08	3.71	4.05	A+	
	2.00	3.50	3.50	7.10	—	1.60	3.12	3.12	4.86	—	4.40	12.70	14.30	0.55	3.42	4.30	2.44	15.19	19.08	3.71	4.05	A+	
	2.00	3.50	4.20	4.20	—	1.66	3.25	3.90	3.90	—	4.40	12.70	14.30	0.55	3.42	4.30	2.44	15.19	19.08	3.71	4.05	A+	
	2.00	3.50	4.20	5.00	—	1.60	3.14	3.77	4.19	—	4.40	12.70	14.30	0.55	3.42	4.30	2.44	15.19	19.08	3.71	4.05	A+	
	2.00	3.50	4.20	7.10	—	1.52	2.98	3.57	4.63	—	4.40	12.70	14.30	0.55	3.42	4.30	2.44	15.19	19.08	3.71	4.05	A+	
	2.00	4.20	4.20	4.20	—	1.58	3.71	3.71	3.71	—	4.40	12.70	14.30	0.55	3.42	4.30	2.44	15.19	19.08	3.71	4.05	A+	
	2.00	4.20	4.20	5.00	—	1.53	3.59	3.59	3.99	—	4.40	12.70	14.30	0.55	3.42	4.30	2.44	15.19	19.08	3.71	4.05	A+	
	2.00	4.20	4.20	7.10	—	1.45	3.41	3.41	4.42	—	4.40	12.70	14.30	0.55	3.42	4.30	2.44	15.19	19.08	3.71	4.05	A+	
	2.00	5.00	5.00	5.00	—	1.44	3.75	3.75	3.75	—	4.40	12.70	14.30	0.55	3.42	4.30	2.44	15.19	19.08	3.71	4.05	A+	
	2.50	2.50	2.50	2.50	—	3.18	3.18	3.18	3.18	—	4.40	12.70	14.30	0.55	3.42	4.30	2.44	15.19	19.08	3.71	4.05	A+	
	2.50	2.50	2.50	3.50	—	2.99	2.99	2.99	3.74	—	4.40	12.70	14.30	0.55	3.42	4.30	2.44	15.19	19.08	3.71	4.05	A+	
	2.50	2.50	2.50	4.20	—	2.82	2.82	2.82	4.23	—	4.40	12.70	14.30	0.55	3.42	4.30	2.44	15.19	19.08	3.71	4.05	A+	
	2.50	2.50	2.50	5.00	—	2.72	2.72	2.72	4.54	—	4.40	12.70	14.30	0.55	3.42	4.30	2.44	15.19	19.08	3.71	4.05	A+	
	2.50	2.50	2.50	7.10	—	2.57	2.57	2.57	4.99	—	4.40	12.70	14.30	0.55	3.42	4.30	2.44	15.19	19.08	3.71	4.05	A+	
	2.50	2.50	3.50	3.50	—	2.82	2.82	3.53	3.53	—	4.40	12.70	14.30	0.55	3.42	4.30	2.44	15.19	19.08	3.71	4.05	A+	
	2.50	2.50	3.50	4.20	—	2.67	2.67	3.34	4.01	—	4.40	12.70	14.30	0.55	3.42	4.30	2.44	15.19	19.08	3.71	4.05	A+	
	2.50	2.50	3.50	5.00	—	2.58	2.58	3.23	4.31	—	4.40	12.70	14.30	0.55	3.42	4.30	2.44	15.19	19.08	3.71	4.05	A+	
	2.50	2.50	3.50	7.10	—	2.44	2.44	3.06	4.75	—	4.40	12.70	14.30	0.55	3.42	4.30	2.44	15.19	19.08	3.71	4.05	A+	
	2.50	2.50	4.20	4.20	—	2.54	2.54	3.81	3.81	—	4.40	12.70	14.30	0.55	3.42	4.30	2.44	15.19	19.08	3.71	4.05	A+	
	2.50	2.50	4.20	5.00	—	2.46	2.46	3.69	4.10	—	4.40	12.70	14.30	0.55	3.42	4.30	2.44	15.19	19.08	3.71	4.05	A+	
	2.50	2.50	4.20	7.10	—	2.33	2.33	3.50	4.54	—	4.40	12.70	14.30	0.55	3.42	4.30	2.44	15.19	19.08	3.71	4.05	A+	
	2.50	2.50	5.00	5.00	—	2.38	2.38	3.97	3.97	—	4.40	12.70	14.30	0.55	3.42	4.30	2.44	15.19	19.08	3.71	4.05	A+	
2.50	2.50	5.00	7.10	—	2.26	2.26	3.77	4.40	—	4.40													

MULTISPLIT COMBINATIONS TABLE







5U125S2SN1FA Inverter (The values in the table refer to the FLEXIS series)

HEATING																							
Combinations					Output power (kW)					System output power (kW)			Absorbed power (kW)			Absorbed current (A)			COP	SCOP	Energy class		
UI	A	B	C	D	E	A	B	C	D	E	min	nom	max	min	nom	max	min	nom	max	max			
5	2,00	2,00	2,00	2,00	2,00	2,30	2,30	2,30	2,30	2,30	4,20	11,50	14,30	0,55	3,08	4,30	2,44	13,66	19,08	3,73	4,05	A+	
	2,00	2,00	2,00	2,00	2,50	2,28	2,28	2,28	2,28	3,57	4,20	12,70	14,30	0,55	3,40	4,30	2,44	15,10	19,08	3,73	4,05	A+	
	2,00	2,00	2,00	2,00	3,50	2,13	2,13	2,13	2,13	4,17	4,20	12,70	14,30	0,55	3,40	4,30	2,44	15,10	19,08	3,73	4,05	A+	
	2,00	2,00	2,00	2,00	4,20	2,00	2,00	2,00	2,00	4,70	4,20	12,70	14,30	0,55	3,40	4,30	2,44	15,10	19,08	3,73	4,05	A+	
	2,00	2,00	2,00	2,00	5,00	1,92	1,92	1,92	1,92	5,01	4,20	12,70	14,30	0,55	3,40	4,30	2,44	15,10	19,08	3,73	4,05	A+	
	2,00	2,00	2,00	2,00	7,10	1,80	1,80	1,80	1,80	5,49	4,20	12,70	14,30	0,55	3,40	4,30	2,44	15,10	19,08	3,73	4,05	A+	
	2,00	2,00	2,00	2,50	2,50	2,07	2,07	2,07	3,24	3,24	4,20	12,70	14,30	0,55	3,40	4,30	2,44	15,10	19,08	3,73	4,05	A+	
	2,00	2,00	2,00	2,50	3,50	1,95	1,95	1,95	3,05	3,81	4,20	12,70	14,30	0,55	3,40	4,30	2,44	15,10	19,08	3,73	4,05	A+	
	2,00	2,00	2,00	2,50	4,20	1,84	1,84	1,84	2,88	4,31	4,20	12,70	14,30	0,55	3,40	4,30	2,44	15,10	19,08	3,73	4,05	A+	
	2,00	2,00	2,00	2,50	5,00	1,77	1,77	1,77	2,77	4,62	4,20	12,70	14,30	0,55	3,40	4,30	2,44	15,10	19,08	3,73	4,05	A+	
	2,00	2,00	2,00	2,50	7,10	1,67	1,67	1,67	2,61	5,08	4,20	12,70	14,30	0,55	3,40	4,30	2,44	15,10	19,08	3,73	4,05	A+	
	2,00	2,00	2,00	3,50	3,50	1,84	1,84	1,84	3,59	3,59	4,40	12,70	14,30	0,55	3,40	4,30	2,44	15,10	19,08	3,73	4,05	A+	
	2,00	2,00	2,00	3,50	4,20	1,74	1,74	1,74	3,40	4,08	4,40	12,70	14,30	0,55	3,40	4,30	2,44	15,10	19,08	3,73	4,05	A+	
	2,00	2,00	2,00	3,50	5,00	1,68	1,68	1,68	3,28	4,38	4,40	12,70	14,30	0,55	3,40	4,30	2,44	15,10	19,08	3,73	4,05	A+	
	2,00	2,00	2,00	3,50	7,10	1,59	1,59	1,59	3,11	4,83	4,40	12,70	14,30	0,55	3,40	4,30	2,44	15,10	19,08	3,73	4,05	A+	
	2,00	2,00	2,00	4,20	4,20	1,65	1,65	1,65	3,87	3,87	4,40	12,70	14,30	0,55	3,40	4,30	2,44	15,10	19,08	3,73	4,05	A+	
	2,00	2,00	2,00	4,20	5,00	1,60	1,60	1,60	3,75	4,16	4,40	12,70	14,30	0,55	3,40	4,30	2,44	15,10	19,08	3,73	4,05	A+	
	2,00	2,00	2,00	4,20	7,10	1,51	1,51	1,51	3,55	4,61	4,40	12,70	14,30	0,55	3,40	4,30	2,44	15,10	19,08	3,73	4,05	A+	
	2,00	2,00	2,50	2,50	2,50	1,90	1,90	2,97	2,97	2,97	4,40	12,70	14,30	0,55	3,40	4,30	2,44	15,10	19,08	3,73	4,05	A+	
	2,00	2,00	2,50	2,50	3,50	1,79	1,79	2,80	2,80	3,51	4,40	12,70	14,30	0,55	3,40	4,30	2,44	15,10	19,08	3,73	4,05	A+	
	2,00	2,00	2,50	2,50	4,20	1,70	1,70	2,66	2,66	3,99	4,40	12,70	14,30	0,55	3,40	4,30	2,44	15,10	19,08	3,73	4,05	A+	
	2,00	2,00	2,50	2,50	5,00	1,64	1,64	2,57	2,57	4,28	4,40	12,70	14,30	0,55	3,40	4,30	2,44	15,10	19,08	3,73	4,05	A+	
	2,00	2,00	2,50	2,50	7,10	1,55	1,55	2,43	2,43	4,73	4,40	12,70	14,30	0,55	3,40	4,30	2,44	15,10	19,08	3,73	4,05	A+	
	2,00	2,00	2,50	3,50	3,50	1,70	1,70	2,66	3,32	3,32	4,40	12,70	14,30	0,55	3,40	4,30	2,44	15,10	19,08	3,73	4,05	A+	
	2,00	2,00	2,50	3,50	4,20	1,61	1,61	2,53	3,16	3,79	4,40	12,70	14,30	0,55	3,40	4,30	2,44	15,10	19,08	3,73	4,05	A+	
	2,00	2,00	2,50	3,50	5,00	1,56	1,56	2,44	3,06	4,07	4,40	12,70	14,30	0,55	3,40	4,30	2,44	15,10	19,08	3,73	4,05	A+	
	2,00	2,00	2,50	3,50	7,10	1,48	1,48	2,32	2,90	4,51	4,40	12,70	14,30	0,55	3,40	4,30	2,44	15,10	19,08	3,73	4,05	A+	
	2,00	2,00	2,50	4,20	4,20	1,54	1,54	2,41	3,61	3,61	4,40	12,70	14,30	0,55	3,40	4,30	2,44	15,10	19,08	3,73	4,05	A+	
	2,00	2,00	2,50	4,20	5,00	1,49	1,49	2,33	3,50	3,89	4,40	12,70	14,30	0,55	3,40	4,30	2,44	15,10	19,08	3,73	4,05	A+	
	2,00	2,00	2,50	4,20	7,10	1,42	1,42	2,22	3,33	4,32	4,40	12,70	14,30	0,55	3,40	4,30	2,44	15,10	19,08	3,73	4,05	A+	
	2,00	2,00	3,50	3,50	3,50	1,61	1,61	3,16	3,16	3,16	4,40	12,70	14,30	0,55	3,40	4,30	2,44	15,10	19,08	3,73	4,05	A+	
	2,00	2,00	3,50	3,50	4,20	1,54	1,54	3,01	3,01	3,61	4,40	12,70	14,30	0,55	3,40	4,30	2,44	15,10	19,08	3,73	4,05	A+	
	2,00	2,00	3,50	3,50	5,00	1,49	1,49	2,92	2,92	3,89	4,40	12,70	14,30	0,55	3,40	4,30	2,44	15,10	19,08	3,73	4,05	A+	
	2,00	2,00	3,50	3,50	7,10	1,42	1,42	2,77	2,77	4,32	4,40	12,70	14,30	0,55	3,40	4,30	2,44	15,10	19,08	3,73	4,05	A+	
	2,00	2,50	2,50	2,50	2,50	1,75	2,74	2,74	2,74	2,74	4,40	12,70	14,30	0,55	3,40	4,30	2,44	15,10	19,08	3,73	4,05	A+	
	2,00	2,50	2,50	2,50	3,50	1,66	2,60	2,60	2,60	3,25	4,40	12,70	14,30	0,55	3,40	4,30	2,44	15,10	19,08	3,73	4,05	A+	
	2,00	2,50	2,50	2,50	4,20	1,58	2,47	2,47	2,47	3,71	4,40	12,70	14,30	0,55	3,40	4,30	2,44	15,10	19,08	3,73	4,05	A+	
	2,00	2,50	2,50	2,50	5,00	1,53	2,39	2,39	2,39	3,99	4,40	12,70	14,30	0,55	3,40	4,30	2,44	15,10	19,08	3,73	4,05	A+	
	2,00	2,50	2,50	2,50	7,10	1,45	2,27	2,27	2,27	4,42	4,40	12,70	14,30	0,55	3,40	4,30	2,44	15,10	19,08	3,73	4,05	A+	
	2,00	2,50	2,50	3,50	3,50	1,58	2,47	2,47	3,09	3,09	4,40	12,70	14,30	0,55	3,40	4,30	2,44	15,10	19,08	3,73	4,05	A+	
	2,00	2,50	2,50	3,50	4,20	1,51	2,36	2,36	2,95	3,54	4,40	12,70	14,30	0,55	3,40	4,30	2,44	15,10	19,08	3,73	4,05	A+	
	2,00	2,50	2,50	3,50	5,00	1,46	2,29	2,29	2,86	3,81	4,40	12,70	14,30	0,55	3,40	4,30	2,44	15,10	19,08	3,73	4,05	A+	
	2,00	2,50	2,50	3,50	7,10	1,39	2,18	2,18	2,72	4,23	4,40	12,70	14,30	0,55	3,40	4,30	2,44	15,10	19,08	3,73	4,05	A+	
	2,00	2,50	3,50	3,50	3,50	1,51	2,36	2,95	2,95	2,95	4,40	12,70	14,30	0,55	3,40	4,30	2,44	15,10	19,08	3,73	4,05	A+	
	2,00	2,50	3,50	3,50	4,20	1,44	2,25	2,82	2,82	3,38	4,40	12,70	14,30	0,55	3,40	4,30	2,44	15,10	19,08	3,73	4,05	A+	
	2,00	2,50	3,50	3,50	5,00	1,40	2,19	2,73	2,73	3,65	4,40	12,70	14,30	0,55	3,40	4,30	2,44	15,10	19,08	3,73	4,05	A+	
	2,00	2,50	3,50	3,50	7,10	1,33	2,09	2,61	2,61	4,06	4,40	12,70	14,30	0,55	3,40	4,30	2,44	15,10	19,08	3,73	4,05	A+	
	2,50	2,50	2,50	2,50	2,50	2,54	2,54	2,54	2,54	2,54	4,40	12,70	14,30	0,55	3,40	4,30	2,44	15,10	19,08	3,73	4,05	A+	
2,50	2,50	2,50	2,50	3,50	2,42	2,42	2,42	2,42	3,02	4,40	12,70	14,30	0,55	3,40	4,30	2,44	15,10	19,08	3,73	4,05	A+		
2,50	2,50	2,50	2,50	4,20	2,31	2,31	2,31	2,31	3,46	4,40	12,70	14,30	0,55	3,40	4,30	2,44	15,10	19,08	3,73	4,05	A+		
2,50	2,50	2,50	2,50	5,00	2,24	2,24	2,24	2,24	3,74	4,40	12,70	14,30	0,55	3,40	4,30	2,44	15,10	19,08	3,73	4,05	A+		
2,50	2,50	2,50	2,50	7,10	2,14	2,14	2,14	2,14	4,15	4,40	12,70	14,30	0,55	3,40	4,30	2,44	15,10	19,08	3,73	4,05	A+		
2,50	2,50	2,50	3,50	3,50	2,31	2,31	2,31	2,89	2,89	4,40	12,70	14,30	0,55	3,40	4,30	2,44	15,10	19,08	3,73	4,05	A+		
2,50	2,50	2,50	3,50	4,20	2,21	2,21	2,21	2,76	3,31	4,40	12,70	14,30	0,55	3,40	4,30	2,44	15,10	19,08	3,73	4,05	A+		
2,50	2,50	2,50	3,50	5,00	2,15	2,15	2,15	2,68	3,58	4,40	12,70	14,30	0,55	3,40	4,30	2,44	15,10	19,08	3,73	4,05	A+		
2,50	2,50	2,50	3,50	7,10	2,05	2,05	2,05	2,56	3,99	4,40	12,70	14,30	0,55	3,40	4,30	2,44	15,10	19,08	3,73	4,05	A+		
2,50	2,50	2,50	4,20	4,20	2,12	2,12	2,12	3,18	3,18	4,40	12,70	14,30	0,55	3,40	4,30	2,44	15,10	19,08	3,73	4,05	A+		
2,50	2,50	2,50	4,20	5,00	2,06	2,06	2,06	3,09	3,43	4,40	12,70	14,30	0,55	3,40	4,30	2,44	15,10	19,08	3,73	4,05	A+		
2,50	2,50	2,50	5,00	5,00	2,01	2,01	2,01	3,34	3,34	4,40	12,70</												



MAXI SPLIT











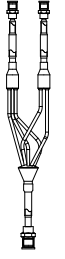

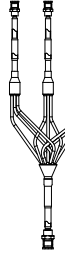
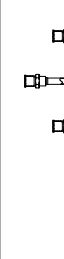

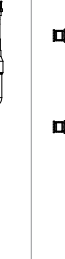
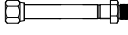
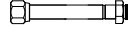
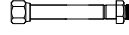

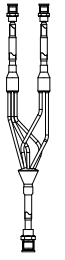

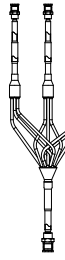
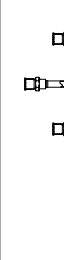

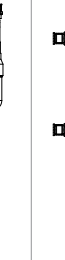
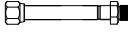
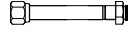
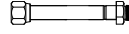
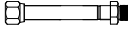
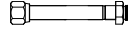
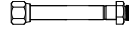

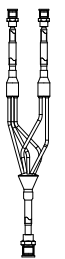

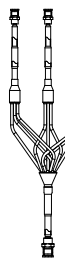
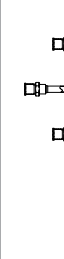
INDOOR UNITS		CASSETTE			CEILING FLOOR		
							
OUTDOOR UNITS		1:2	1:3	1:4	1:2	1:3	1:4
10,5 kW		AB50S2SC2FA(H)	AB35S2SC2FA(H)	N/A	AC50S2SG1FA(H)	AC35S2SG1FA(H)	N/A
		AB50S2SC2FA(H)	AB35S2SC2FA(H) AB35S2SC2FA(H)		AC50S2SG1FA(H)	AC35S2SG1FA(H) AC35S2SG1FA(H)	
SINGLE-PHASE	1U105S2SS2FA	JOINT KIT FQG-2Y100A	JOINT KIT FQG-3Y200A + ADAPTER	N/A	JOINT KIT FQG-2Y100A	JOINT KIT FQG-3Y200A + ADAPTER	N/A
12,5 kW		AB71S2SG1FA(H)	AB50S2SC2FA(H)	AB35S2SC2FA(H)	AC71S2SG1FA(H)	AC50S2SG1FA(H)	AC35S2SG1FA(H)
		AB71S2SG1FA(H)	AB50S2SC2FA(H) AB50S2SC2FA(H)	AB35S2SC2FA(H) AB35S2SC2FA(H) AB35S2SC2FA(H)	AC71S2SG1FA(H)	AC50S2SG1FA(H) AC50S2SG1FA(H)	AC35S2SG1FA(H) AC35S2SG1FA(H)
SINGLE-PHASE	1U125S2SN2FA	JOINT KIT FQG-2Y200A + ADAPTER	JOINT KIT FQG-3Y200A + ADAPTER	JOINT KIT FQG-4Y200A + ADAPTER	JOINT KIT FQG-2Y200A + ADAPTER	JOINT KIT FQG-3Y200A + ADAPTER	JOINT KIT FQG-4Y200A + ADAPTER
THREE-PHASE	1U125S2SN2FB						
14,0 kW		AB71S2SG1FA(H)	AB50S2SC2FA(H)	AB35S2SC2FA(H)	AC71S2SG1FA(H)	AC50S2SG1FA(H)	AC35S2SG1FA(H)
		AB71S2SG1FA(H)	AB50S2SC2FA(H) AB50S2SC2FA(H)	AB35S2SC2FA(H) AB35S2SC2FA(H) AB35S2SC2FA(H)	AC71S2SG1FA(H)	AC50S2SG1FA(H) AC50S2SG1FA(H)	AC35S2SG1FA(H) AC35S2SG1FA(H)
SINGLE-PHASE	1U140S2SN1FA	JOINT KIT FQG-2Y200A + ADAPTER	JOINT KIT FQG-3Y200A + ADAPTER	JOINT KIT FQG-4Y200A + ADAPTER	JOINT KIT FQG-2Y200A + ADAPTER	JOINT KIT FQG-3Y200A + ADAPTER	JOINT KIT FQG-4Y200A + ADAPTER
THREE-PHASE	1U140S2SN1FB						
16,0 kW		AB71S2SG1FA(H)	AB50S2SC2FA(H)	AB35S2SC2FA(H)	AC71S2SG1FA(H)	AC50S2SG1FA(H)	AC35S2SG1FA(H)
		AB71S2SG1FA(H)	AB50S2SC2FA(H) AB50S2SC2FA(H)	AB35S2SC2FA(H) AB35S2SC2FA(H) AB35S2SC2FA(H)	AC71S2SG1FA(H)	AC50S2SG1FA(H) AC50S2SG1FA(H)	AC35S2SG1FA(H) AC35S2SG1FA(H)
THREE-PHASE	1U160S2SP1FB	JOINT KIT FQG-2Y200A + ADAPTER	JOINT KIT FQG-3Y200A + ADAPTER	JOINT KIT FQG-4Y200A + ADAPTER	JOINT KIT FQG-2Y200A + ADAPTER	JOINT KIT FQG-3Y200A + ADAPTER	JOINT KIT FQG-4Y200A + ADAPTER

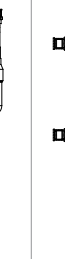
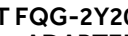
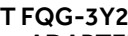
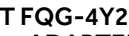
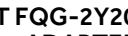
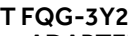
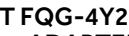
CONTROLLERS AND ACCESSORIES OPTIONAL		WIRED CONTROLLERS (REQUIRED FOR SYSTEM)	
			
		HW-SA201ABK	YR-E16B

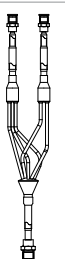
SLIM DUCT LOW PRESSURE			DUCTED MEDIUM PRESSURE		
1:2	1:3	1:4	1:2	1:3	1:4
AD35S2SS1FA(H) AD35S2SS1FA(H)	AD35S2SS1FA(H) AD35S2SS1FA(H) AD35S2SM3FA(H)	N/A	AD50S2SM3FA(H) AD50S2SM3FA(H)	AD35S2SM3FA(H) AD35S2SM3FA(H) AD35S2SM3FA(H)	N/A
JOINT KIT FQG-2Y100A	JOINT KIT FQG-3Y200A + ADAPTATEUR	N/A	JOINT KIT FQG-2Y100A	JOINT KIT FQG-3Y200A + ADAPTATEUR	N/A
AD71S2SS1FA(H) AD71S2SS1FA(H)	AD50S2SS1FA(H) AD50S2SS1FA(H) AD50S2SS1FA(H)	AD35S2SS1FA(H) AD35S2SS1FA(H) AD35S2SS1FA(H) AD35S2SS1FA(H)	AD71S2SM3FA(H) AD71S2SM3FA(H)	AD50S2SM3FA(H) AD50S2SM3FA(H) AD50S2SM3FA(H)	AD35S2SM3FA(H) AD35S2SM3FA(H) AD35S2SM3FA(H) AD35S2SM3FA(H)
JOINT KIT FQG-2Y200A + ADAPTATEUR	JOINT KIT FQG-3Y200A + ADAPTATEUR	JOINT KIT FQG-4Y200A + ADAPTATEUR	JOINT KIT FQG-2Y200A + ADAPTATEUR	JOINT KIT FQG-3Y200A + ADAPTATEUR	JOINT KIT FQG-4Y200A + ADAPTATEUR
AD71S2SS1FA(H) AD71S2SS1FA(H)	AD50S2SS1FA(H) AD50S2SS1FA(H) AD50S2SS1FA(H)	AD35S2SS1FA(H) AD35S2SS1FA(H) AD35S2SS1FA(H) AD35S2SS1FA(H)	AD71S2SM3FA(H) AD71S2SM3FA(H)	AD50S2SM3FA(H) AD50S2SM3FA(H) AD50S2SM3FA(H)	AD35S2SM3FA(H) AD35S2SM3FA(H) AD35S2SM3FA(H) AD35S2SM3FA(H)
JOINT KIT FQG-2Y200A + ADAPTATEUR	JOINT KIT FQG-3Y200A + ADAPTATEUR	JOINT KIT FQG-4Y200A + ADAPTATEUR	JOINT KIT FQG-2Y200A + ADAPTATEUR	JOINT KIT FQG-3Y200A + ADAPTATEUR	JOINT KIT FQG-4Y200A + ADAPTATEUR
AD71S2SS1FA(H) AD71S2SS1FA(H)	AD50S2SS1FA(H) AD50S2SS1FA(H) AD50S2SS1FA(H)	AD35S2SS1FA(H) AD35S2SS1FA(H) AD35S2SS1FA(H) AD35S2SS1FA(H)	AD71S2SM3FA(H) AD71S2SM3FA(H)	AD50S2SM3FA(H) AD50S2SM3FA(H) AD50S2SM3FA(H)	AD35S2SM3FA(H) AD35S2SM3FA(H) AD35S2SM3FA(H) AD35S2SM3FA(H)
JOINT KIT FQG-2Y200A + ADAPTATEUR	JOINT KIT FQG-3Y200A + ADAPTATEUR	JOINT KIT FQG-4Y200A + ADAPTATEUR	JOINT KIT FQG-2Y200A + ADAPTATEUR	JOINT KIT FQG-3Y200A + ADAPTATEUR	JOINT KIT FQG-4Y200A + ADAPTATEUR

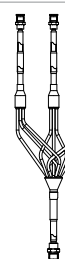
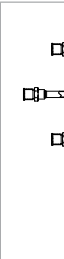
CENTRAL CONTROLLERS		BMS
HC-SA164DBT	YCZ-A004	HCM-06

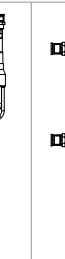
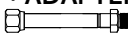
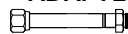
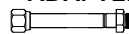
OUTDOOR UNITS		1:2		1:3		1:4	
10,5 kW							
		LIQUID	GAS	LIQUID	GAS	LIQUID	GAS
SINGLE-PHASE	1U105S2SS2FA	JOINT KIT FQG-2Y100A + ADAPTER 		JOINT KIT FQG-3Y200A + ADAPTER 		JOINT KIT FQG-4Y200A + ADAPTER 	
12,5 kW							
		LIQUID	GAS	LIQUID	GAS	LIQUID	GAS
SINGLE-PHASE	1U125S2SN2FA	JOINT KIT FQG-2Y200A + ADAPTER 		JOINT KIT FQG-3Y200A + ADAPTER 		JOINT KIT FQG-4Y200A + ADAPTER 	
THREE-PHASE	1U125S2SN2FB	JOINT KIT FQG-2Y200A + ADAPTER 		JOINT KIT FQG-3Y200A + ADAPTER 		JOINT KIT FQG-4Y200A + ADAPTER 	
14,0 kW	 						
		LIQUID	GAS	LIQUID	GAS	LIQUID	GAS
SINGLE-PHASE	1U140S2SN1FA	JOINT KIT FQG-2Y200A + ADAPTER 		JOINT KIT FQG-3Y200A + ADAPTER 		JOINT KIT FQG-4Y200A + ADAPTER 	
THREE-PHASE	1U140S2SN1FB	JOINT KIT FQG-2Y200A + ADAPTER 		JOINT KIT FQG-3Y200A + ADAPTER 		JOINT KIT FQG-4Y200A + ADAPTER 	
16,0 kW							
		LIQUID	GAS	LIQUID	GAS	LIQUID	GAS
THREE-PHASE	1U160S2SP1FB	JOINT KIT FQG-2Y200A + ADAPTER 		JOINT KIT FQG-3Y200A + ADAPTER 		JOINT KIT FQG-4Y200A + ADAPTER 	

SPECIFICATIONS

EXTERNAL UNIT	INTERNAL UNIT	UNIT N° INTERNAL	COMMAND WIRE	GAS	LIQUID	JOINT
1U105S2SS2FA	AB50S2SC2FA(H) AD50S2SS1FA(H) AD50S2SM3FA(H) AC50S2SG1FA(H)	2	HW-SA201ABK			FQG-2Y100A
1U125S2SN2FA 1U125S2SN2FB 1U140S2SN1FA 1U140S2SN1FB 1U140S2SP2FA 1U140S2SP2FB 1U160S2SP1FB	AB71S2SG1FA(H) AD71S2SS1FA(H) AD71S2SM3FA(H) AC71S2SG1FA(H)	2	HW-SA201ABK			FQG-2Y200A
1U105S2SS2FA	AB35S2SC2FA(H) AD35S2SS1FA(H) AD35S2SM3FA(H) AC35S2SG1FA(H)	3	HW-SA201ABK			FQG-3Y100A
1U125S2SN2FA 1U125S2SN2FB 1U140S2SN1FA 1U140S2SN1FB 1U140S2SP2FA 1U140S2SP2FB 1U160S2SP1FB	AB50S2SC2FA(H) AD50S2SS1FA(H) AD50S2SM3FA(H) AC50S2SG1FA(H)	3	HW-SA201ABK			FQG-3Y200A
1U105S2SS2FA 1U125S2SN2FA 1U125S2SN2FB 1U140S2SN1FA 1U140S2SN1FB 1U140S2SP2FA 1U140S2SP2FB 1U160S2SP1FB	AB35S2SC2FA(H) AD35S2SS1FA(H) AD35S2SM3FA(H) AC35S2SG1FA(H)	4	HW-SA201ABK			FQG-4Y200A

PIPE SPECIFICATIONS

N° UI	Pipe Diagram	Max pipe length (m)			Max altitude difference UE - UI (m)			Max length single UI (m)			Max altitude difference UI - UI (m)			Max difference pipe length (m)			Pipe diameter (mm)			Joint diameter (mm)		
		L1	L2	L3	H	L1	L2	L3	H1	(Lx-Ly) x,y=1,2,3 x≠y	liquid / gas	liquid / gas	liquid / gas	liquid / gas	liquid / gas	liquid / gas						
2		L1 + L1 + L2			H			L1 o L2			H1			L1 - L2			liquid / gas			liquid / gas		
		1U 105	1U 125	1U 140 160	1U 105	1U 125	1U 140 160	1U 105	1U 125	1U 140 160	1U 105	1U 125	1U 140 160	1U 105	1U 125	1U 140 160	1U 105	1U 125	1U 140 160	1U 105	1U 125	1U 140 160
		≤50	≤50	≤75	≤30	≤30	≤30	≤20			≤0,5			≤10			9,52 15,88	9,52 15,88	9,52 15,88	9,52 15,88	9,52 15,88	9,52 15,88
3		L1 + L1 + L2			H			L1 o L2 o L3			H1			(Lx-Ly) x,y=1,2,3 x≠y			liquid / gas			liquid / gas		
		1U 105	1U 125	1U 140 160	1U 105	1U 125	1U 140 160	1U 105	1U 125	1U 140 160	1U 105	1U 125	1U 140 160	1U 105	1U 125	1U 140 160	1U 105	1U 125	1U 140 160	1U 105	1U 125	1U 140 160
		≤50	≤60	≤75	≤20	≤30	≤30	≤20			≤0,5			≤10			9,52 15,88	9,52 15,88	9,52 15,88	6,35 9,52	6,35 12,7	6,35 12,7
4		L+L1+L2+L3+L4			H			L1 o L2 o L3 o L4			H1			(Lx-Ly) x,y=1,2,3,4 x≠y			liquid / gas			liquid / gas		
		1U 105	1U 125	1U 140 160	1U 105	1U 125	1U 140 160	1U 105	1U 125	1U 140 160	1U 105	1U 125	1U 140 160	1U 105	1U 125	1U 140 160	1U 105	1U 125	1U 140 160	1U 105	1U 125	1U 140 160
		≤50	≤60	≤75	≤20	≤30	≤30	≤20	≤20	≤20	≤0,5	≤0,5	≤0,5	≤10	≤10	≤10	9,52 15,88	9,52 15,88	9,52 15,88	6,35 12,7	6,35 9,52	6,35 9,52

The MAXI SPLIT system is designed to ensure better air distribution.

The use of a practical collector enables the connection of up to 4 internal units (of the same type), running simultaneously to one external unit (mono).

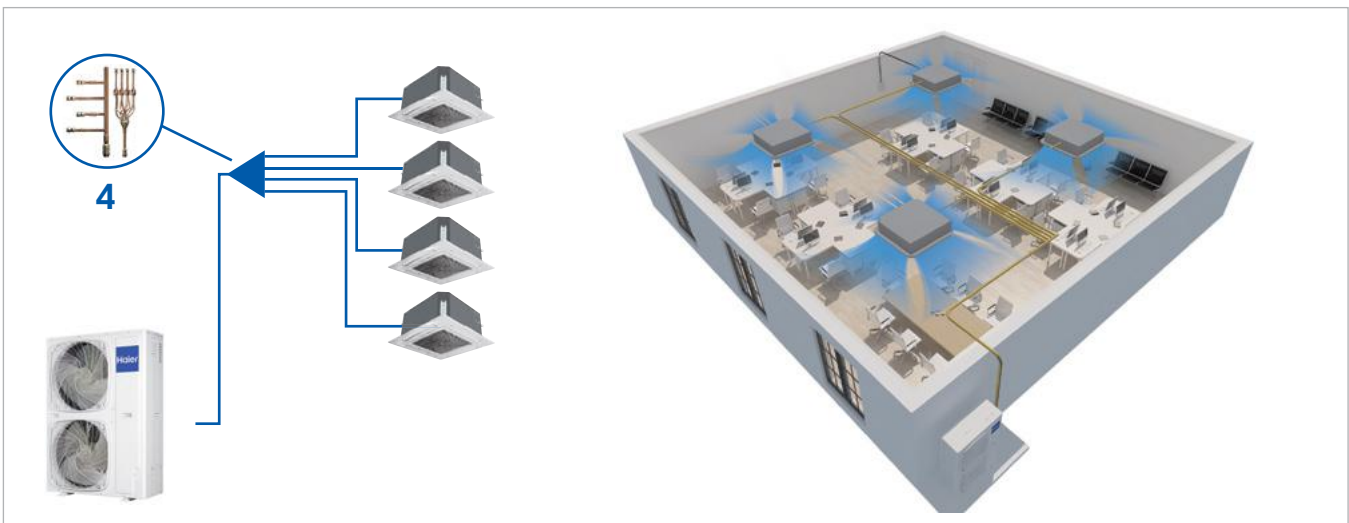
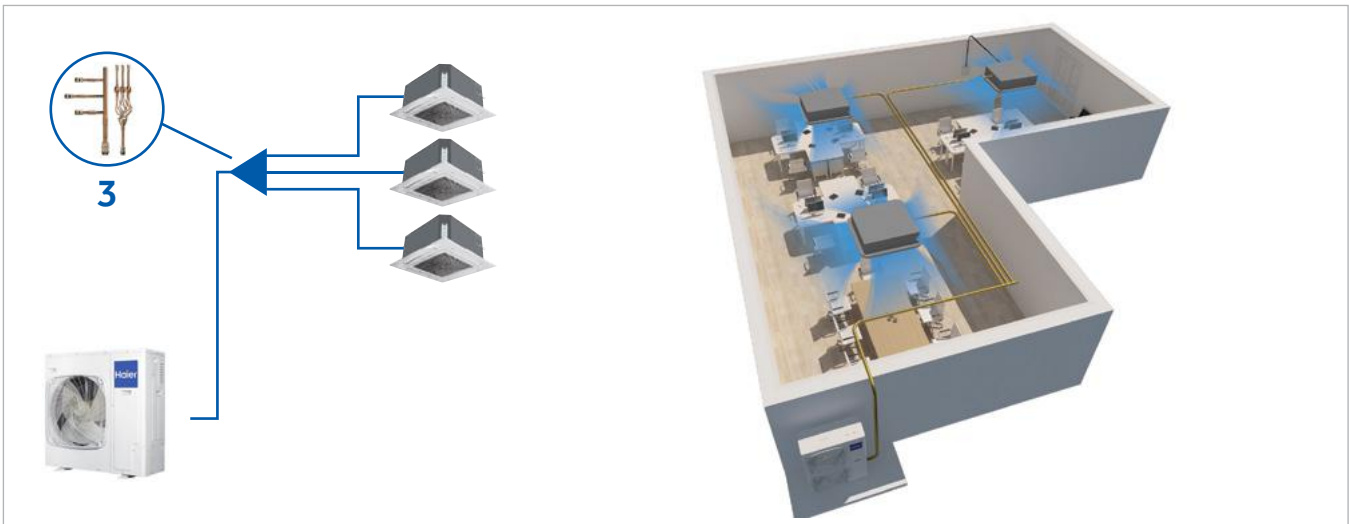
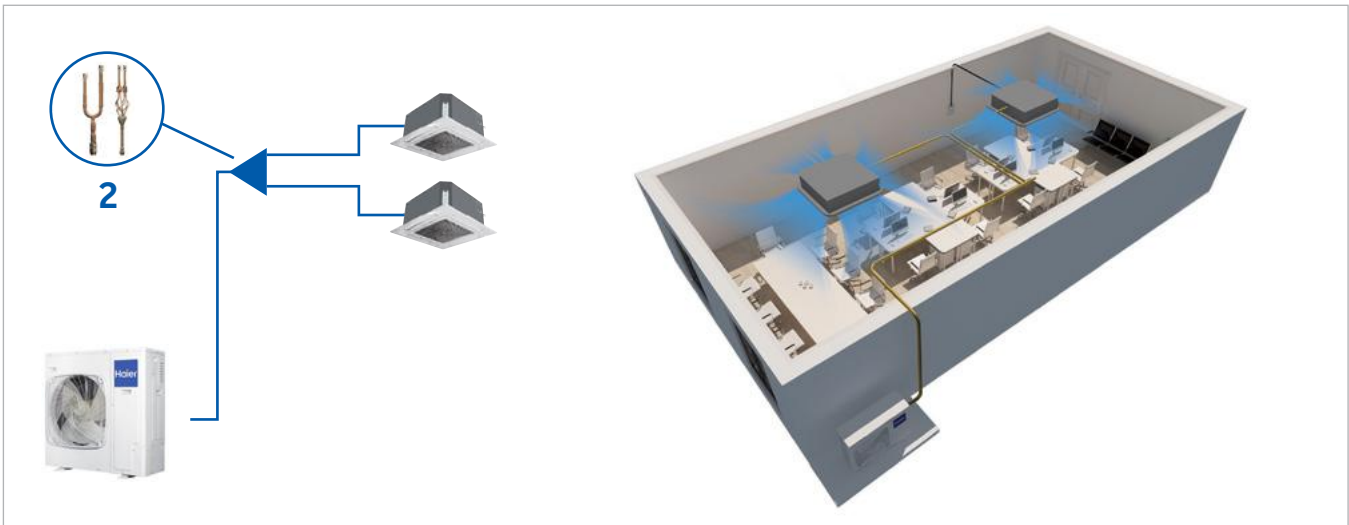

Haier
HVAC Solutions



Haier HVAC
haierhvac.eu

Copyright © 2024 Haier. All rights reserved.