

Commercial & Applied HVAC Solutions

Catalogue 2026



Haier

Haier

More Creation, More Possibilities

Professional, Smart & Healthy Air Solutions Provider

OUR VISION

To be a globally recognised expert in Smart and Healthy Air Solutions.

OUR MISSION

To deliver a complete ecosystem of solutions and services through our innovation in smart technologies. Our mission is to provide our users with the very best in cooling & heating comfort, air quality and efficiencies to create the perfect environment what ever the scenario.

CONTENTS

01	INTRODUCTION & FEATURES	/01	08	MRV INDOOR UNITS	/91
	BRAND STORY	/03		ROUND FLOW CASSETTE	/93
	GLOBAL POSITION	/04		CASSETTE 620	/95
	GLOBAL NETWORK	/05		WALL MOUNTED UNITS	/97
	R&D CENTER	/06		1-WAY CASSETTE	/99
	MILESTONES	/07		2-WAY CASSETTE	/101
	ECOSYSTEM	/08		CEILING - FLOOR CONVERTIBLE	/103
	HVAC EUROPEAN TRAINING HUB	/09		FLOOR CONSOLE - BUILT-IN	/104
	HVAC SOLUTIONS IN EUROPE	/10		FLOOR CONSOLE	/105
	RENEWABLE ENERGY PRODUCTION	/11		COMPACT DUCT LOW-MED PRESSURE	/109
	SELECTION SOFTWARE	/12		DUCTED LOW - MEDIUM PRESSURE	/111
				DUCTED FRESH AIR	/111
				DUCTED MEDIUM PRESSURE	/113
				DUCTED - HIGH PRESSURE	/115
				HYDROBOX	/116
02	THE RANGE	/13	09	EASY MRV	/119
03	MRV7 S	/19	10	TECHNICAL DRAWINGS	/123
	DC INVERTER UNIT WITH R32	/27	11	MRV AHU APPLICATION	/143
04	MRV S II	/32	12	CONTROL SYSTEMS & ACCESSORIES	/150
	FRONT AIR DISCHARGE UNIT	/37			
05	MRV 5-H	/41			
	FULL DC INVERTER	/51			
06	MRV 5-RC	/63			
	3-PIPE HEAT RECOVERY	/67			
07	MRV-W	/79			
	WATER COOLED HEAT PUMP	/87			

BRAND STORY

Today, in the diverse and unconventional age of the Internet, "one size fits all" products and solutions are not enough to satisfy the customer. Customers want to be treated as autonomous individuals and respected for who they are.

Everyone wants their unique lifestyle acknowledged. That is why we listen carefully to our customers in order to gain a genuine understanding of their lifestyle and requirements.

As a global leader, Haier, in addition to innovating its products and solutions, transforms its organisation into a connected platform. In doing so, internal and external resources are connected quickly and easily. We believe only by doing so, we can best meet our customers' expectations in this rapidly evolving world.

Join the Haier network. Create new possibilities.



This warranty includes parts only. For further details and requirement, please contact your Haier partner



GLOBAL POSITION



WORLD'S NO.1 MAJOR APPLIANCES BRAND

Haier has been accredited with being global No.1 in major household appliances by retail sales from 2008-2024, according to data from Euromonitor.



WORLD'S NO.1 SMART AC BRAND

Haier is the world's No.1 connected air conditioner brand, in retail sales 2024, according to data from Euromonitor.



TOP 100 MOST VALUABLE BRANDS

Haier is the world's only IoT Ecosystem Brand that has been ranked in the Kantar BrandZ Top 100 Most Valuable Global Brands for six consecutive years.



TOP 100 GLOBAL CHALLENGERS

With the global landing of the Smart Home ecosystem brand, Haier Smart Home was once again listed on the Fortune Global 500.



"ESG" INTERNATIONAL AWARDS

Haier has received numerous recognitions for its ESG efforts, including the Sustainable Markets Initiative's 2023 Terra Carta Seal.



FORTUNE'S MOST ADMIRABLE COMPANIES

Haier has been named one of the World's Most Admired Companies by Fortune's, making the sixth consecutive year the Company is on this prestigious list.



GLOBAL NETWORK

Haier currently has 10+ R&D centres, 35 industrial parks, 138 manufacturing centres and 126 marketing centres around the world, reaching out to more than 200 countries and regions and serving 1 billion user households.

Haier has 7 major home appliance brands worldwide: Haier, Casarte, Leader, Hoover, AQUA, Fisher & Paykel, GE Appliances and Candy.

Each of these brands offers the best user experience to various consumer groups in many regions and countries around the world.

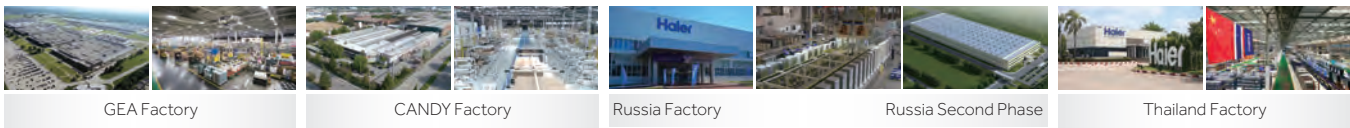

10+N R&D Centers	126 Marketing Centers	35 Industrial Parks	138 Factories	200+ Countries or Regions
----------------------------	---------------------------------	-------------------------------	-------------------------	-------------------------------------

R&D CENTER



R&D Labs



Evaluation of comfort



Rain simulation



Performance testing



Safety testing



Noise testing



Electromagnetic compatibility testing



Snow simulation



Sun simulation



Reliability testing



Humidity control test



Double 85 test



Drop test

Global Certifications



MILESTONES

2025

MRV7 S

Launched Front Discharge with R32

2021

MRV5-C

Launched cooling only series

2020

MRV5-H

Launched MRV5-H

2019

US MRV 5

Launched US MRV 5 HP & HR AHRI certification High efficiency and low operating temperature

2013

MRV III-RC

Heat recovery (3 pipe system)

2014

MRV IV

Full DC inverter, Large single module

2016

MRVII PLUS

Full DC inverter

MRV SII

New platform, new outlook

2018

MRV5-RC

Launched MRV 5-RC heat recovery range

2012

MRV S

Full DC inverter side discharge outdoor largest capacity of side discharge

2008

MRV III DC Inverter

23 Olympic reference projects in Beijing

2005

Modular combination MRV II

First pure DC inverter in China Technology from Toshiba

1999

Commercial VRF

(C-MRV) First Modular VRF unit in China

1993

Haier

Enter into China's commercial AC field

1996

Home VRF

(Home MRV) First unit in China & Haier's first home inverter

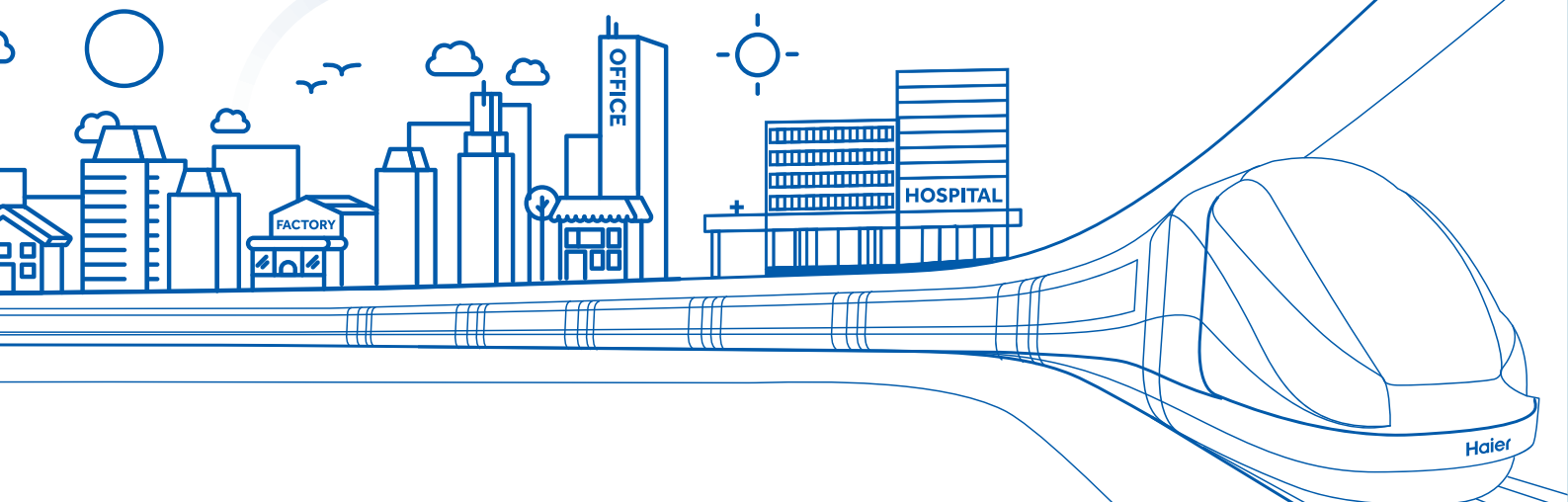

CONNECTED ECOSYSTEM



A2W HEAT PUMP



ENERGY STORAGE



HP WATER HEATER



A2A HEAT PUMP

HVAC EUROPEAN TRAINING HUB



At Haier we are continually investing in opening facilities for our HVAC professionals to train and experience the Haier portfolio. We have many training centres across Europe supported by our partners. To join our training facility in Venice, in 2022 we celebrated the opening of our new HVAC European training centre in Barcelona. The new training Hub can facilitate a range of training programmes which are tailored to the needs of our professional HVAC network. The Hub has welcomed over 3000+ visitors who have all be able to get close to the brand and the complete ecosystem of solutions we have on offer.

The facilities are fully operational with 3 dedicated rooms, which includes products from our portfolio from Residential, Heating and Commercial solutions, giving visitors a truly hands on experience.

We look forward to welcoming our Distributors, Installers and Designers to come and experience Haier's HVAC Solutions first-hand.

Follow us on LinkedIn to keep up to date about upcoming events and products



HVAC SOLUTIONS IN EUROPE

Haier's European HVAC operations has been active for over 30 years where we are fully supported by some of the most talented and dedicated partners and teams across Europe including, Italy, Spain, Portugal, UK, France, Greece, Central Europe and Germany.

These markets carry a wide range of products which includes, Residential & Light Commercial solutions as well as Large Commercial and Heating Solutions, giving us a truly diverse offering to suit various applications from residential to larger Hotels and Retail. Our total production capacity is over 27 million sets per year, supported by 16 Air Conditioning factories with 8 of them being in overseas markets.

This outstanding capacity enables us to continually strive to lead the market in delivering Smart and Healthy solutions across Europe.

Haier HVAC European operations are anchored by two key hubs: Haier Iberia in Barcelona, Spain, serving Spain and other European countries and Haier AC Trading Italy, situated in Revine Lago, which caters to both the Italian and broader European markets.

Recently, the addition of Haier HVAC UK has further strengthened our presence in Europe, contributing to our ongoing growth in the region.



HVAC EUROPEAN TRAINING HUB

Since 2024, our Training Hub in Barcelona has welcomed over 3000 visitors, including installers, designers and distributors, to strengthen their knowledge of Haier's solutions.

The hub has been specifically designed to have a dedicated room for each portfolio: residential, heating, commercial and from 2024 a brand-new floor has welcomed a training room for new energy solutions. In addition, the new 3rd floor gives the opportunity to both internal and external guests to host meetings and workshops, thanks to an additional meeting room and co-working spaces accessible at all times.



Haier solutions for renewable energy production and management

Haier has been investing for years in an integrated ecosystem that combines smart applications, renewable energy, and advanced technologies to improve quality of life and reduce environmental impact. The goal is ambitious: to contribute to the realisation of buildings with zero impact by promoting energy efficiency, reduction of CO₂ emissions, and adoption of natural refrigerants and advanced green technologies to fight global warming. Haier commitment to a more sustainable world has been increasingly more evident thanks to the introduction of Haier Energy, the brand-new Haier division dedicated to the manufacturing and distribution of photovoltaic, energy storage, power

conversion system and electric mobility across the European market through specialized distributors and wholesalers. The benefits of utilizing a comprehensive energy management system that encompasses photovoltaic panels, inverters, batteries, heat pump water heaters and ATW systems for domestic hot water, and heat pump air conditioners are significant. This integrated approach allows for seamless control and monitoring of all components through a single application, hOn. By consolidating these various technologies into one cohesive system, users can optimize energy consumption, enhance efficiency, and reduce

operational costs. Furthermore, the centralized management provided by the hOn app facilitates real-time data analysis and performance tracking, empowering users to make informed decisions regarding their energy usage while contributing to a more sustainable future.



For more scan here



Haier HVAC Solutions boasts a comprehensive portfolio spanning three key sectors: Air Conditioning, Heating and Green Energy. Throughout this portfolio Haier HVAC covers both domestic and commercial solutions but what makes Haier truly unique, is the ability to connect and integrate its range of products to create a one brand solution. Having the ability to do this simplifies all aspects of the supply chain from pre-sales through to after sales support.

The hOn application by Haier can be used to control and manage all Haier products. This gives users complete control over

how they use their energy. The hOn app includes key features such as scheduling the units working time as well as monitoring the energy usage to ensure the system is working to its optimum level.

Haier's one brand solution reinvents the way that domestic and commercial properties consume energy, putting complete control in the hands of the user to ensure all their Haier products are operating in a way that suits the user's lifestyle and environment.

SELECTION SOFTWARE

HAIER SELECTION SOFTWARE

EASY DESIGN AND CUSTOMISATION



With the Haier MRV Selection software, engineers and consultants can easily design layouts and prepare a full MRV system in a few steps. It selects the right models to meet your building load requirements and calculates the piping schematic automatically or manually, as well as the wiring. It's possible to import DWG and JPG drawings. The selection software guides you within design rules and offers a comprehensive system design report in PDF, Word or Excel format. Haier Selection software **supports R32 and R410A systems**, two technologies combined in a single software.

System layout page

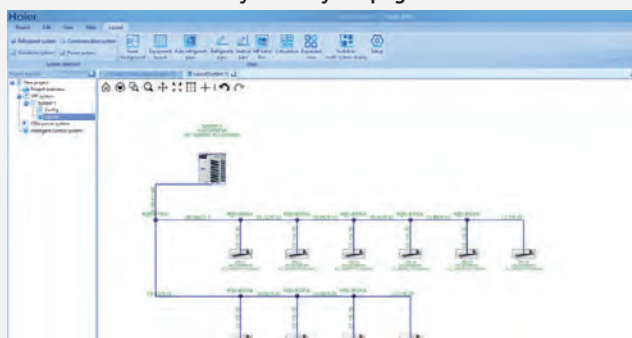

System layout page

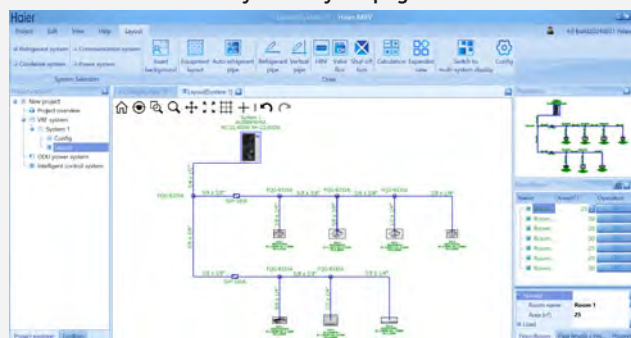

Indoor unit selection window

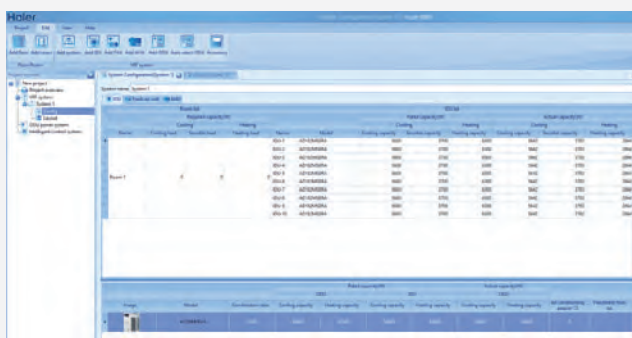

Outdoor unit selection window

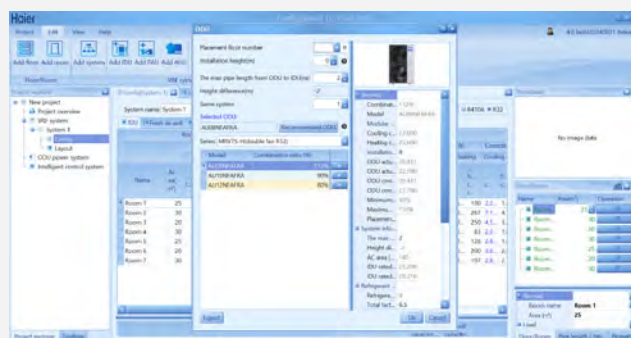

SERVICE TOOL TD-03 WITH MONITORING SOFTWARE

Installers and Service technicians can use TD-03 service tool together with monitoring software for real-time monitoring of the system as well as access to operating data of VRF system through the PC. The running data and parameters can be used to analyse errors for fast troubleshooting. In addition, it is possible to save and export the data for further analysis.

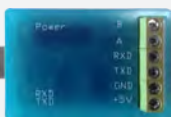

TD-03

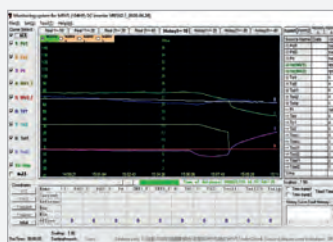
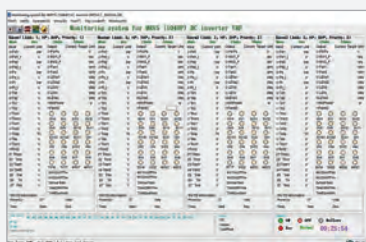

Haier

MRV

Meet the range







OUTDOOR UNIT RANGE

MRV7 S Outdoor Units **R32**

SERIES	4 HP	5 HP	6 HP	4 HP	5 HP	6 HP	8 HP	10 HP	12 HP
Model	AU042FCFRA	AU052FCFRA	AU062FCFRA	AU041FCFRA	AU051FCFRA	AU061FCFRA	AU08NFAFRA	AU10NFAFRA	AU12NFAFRA
MRV7 S									





MRV7 S Accessories **R32**



DESCRIPTION	Shut-off Valve Box	External R32 Leak Detector	Communications Amplifier
Model	SVP-160A	HDEC-R32A	HA-AA110AD
Accessories			

MRV S II Outdoor Units **R410A**

SERIES	4-5 HP	4 HP	5 HP	6 HP	8 HP	10 HP	12 HP
Model	AU042FNRA AU052FNRA	AU042FPERA AU041FPERA	AU052FPERA AU051FPERA	AU062FPERA AU061FPERA	AU08NFKERA	AU10NFKERA	AU12NFKERA
MRV S II							

MRV 5 - H Full DC Inverter 2-pipe Heat Pump **R410A**

SERIES	8 HP	10 HP	12 HP	14 HP	16 HP	18 HP	20 HP	22 HP	24 HP	26 HP	28 HP	30 HP	32 HP	34 HP
Model	AV08	AV10	AV12	AV14	AV16	AV18	AV20	AV22	AV24	AV26	AV28	AV30	AV32	AV34NMVETA
MRV 5 - H	NMVETA			NMVETA				NMVETA			AV34NMVETA			
														

SERIES	36 HP	38 HP	40 HP	42 HP	44 HP	46 HP	48 HP	50 HP	52 HP	54 HP	56 HP	58 HP	60 HP	62 HP	64 HP	66 HP	68 HP	70 HP	72 HP	74 HP	76 HP	78 HP
Model	AV36	AV38	AV40	AV42	AV44	AV46	AV48	AV50	AV52	AV54	AV56	AV58	AV60	AV62	AV64	AV66	AV68	AV70	AV72	AV74	AV76	AV78
MRV 5 - H	NMVETA										NMVETA											
																						

SERIES	80 HP	82 HP	84 HP	86 HP	88 HP	90 HP	92 HP	94 HP	96 HP	98 HP	100 HP	102 HP	104 HP
Model	AV80	AV82	AV84	AV86	AV88	AV90	AV92	AV94	AV96	AV98	AV100	AV102	AV104
MRV 5 - H	NMVETA												
													

OUTDOOR UNIT RANGE

MRV 5 - RC Full DC Inverter 3-pipe Heat Pump R410A

SERIES	8 HP	10 HP	12 HP	14 HP	16 HP	18 HP	20 HP	22 HP	24 HP	26 HP	28 HP	30 HP
Model	AV08	AV10	AV12	AV14	AV16	AV18	AV20	AV22	AV24	AV26	AV28	AV30IMVURA
	IMVURA			IMVURA			IMVURA					
MRV 5-RC												

SERIES	32 HP	34 HP	36 HP	38 HP	40 HP	42 HP	44 HP	46 HP	48 HP	50 HP	52 HP	54 HP	56 HP	58 HP	60 HP	62 HP	64 HP	66 HP
Model	AV32	AV34	AV36	AV38	AV40	AV42	AV44	AV46IMVURA	AV48	AV50	AV52	AV54	AV56	AV58	AV60	AV62	AV64	AV66
	IMVURA							IMVURA			IMVURA							
MRV 5-RC																		

SERIES	68 HP	70 HP	72 HP	74 HP	76 HP	78 HP	80 HP	82 HP	84 HP	86 HP	88 HP
Model	AV68	AV70	AV72	AV74	AV76	AV78	AV80	AV82	AV84	AV86	AV88
	IMVURA										
MRV 5-RC											

MRV 5 - RC 3-pipe connection kit R410A

SERIES	$X \leq 11,2\text{KW}$	$11,2 < X \leq 18\text{KW}$	$18 < X \leq 28\text{KW}$	4 ways - max 11,2kW for single output.
Model	VP1-112C	VP1-180C	VP1-280C	VP4-450C
VP - Boxes				

MRV W Water Cooled Heat Pump Outdoor Units R410A













SERIES	8 HP	10 HP	12 HP	16 HP	18 HP	20 HP	22 HP	24 HP	28 HP	30 HP	32 HP	34 HP	36 HP
Model	AV08	AV10	AV12	AV16	AV18	AV20	AV22	AV24	AV28	AV30	AV32	AV34	AV36
	IMWEWA			IMWEWA			IMWEWA						
MRV-W													

AHU Kit to create direct-expansion air treatment units R410A

SERIES	$3,5 \leq X \leq 7\text{KW}$	$7 \leq X \leq 14\text{KW}$	$14 \leq X \leq 28\text{KW}$	$28 \leq X \leq 56\text{KW}$	$56 \leq X \leq 73\text{KW}$
Model	AH1-070B	AH1-140B	AH1-280B	AH1-560B	AH1-730B
AHU KIT					
MRV Compatibility	MRV5 II / MRV5-H / MRV5-RC. "S" series with front air discharge and "5" series				

INDOOR UNIT RANGE

MRV Indoor Units















SERIES	REFRIGERANT	1,5 kW	2,2 kW	2,8 kW	3,6 kW	4,5 kW	5,6 kW	7,1 kW	8,0 kW	9,0 kW	11,2 kW	14,0 kW	16,0 kW	22,6 kW	28,0 kW	31,0 kW
 ROUND FLOW CASSETTE			•	•	•	•	•	•	•	•	•	•	•			
 CASSETTE 620		•	•	•	•	•	•	•								
 WALL MOUNTED*		•	•	•	•	•	•	•	•	•						
 1 WAY CASSETTE		•	•	•	•	•	•	•								
 2 WAY CASSETTE			•	•	•	•	•	•	•	•	•	•				
 CEILING / FLOOR CONVERTIBLE				•	•	•	•	•	•	•	•	•				
 SLIM DUCTED* LOW PRESSURE (40Pa)		•	•	•	•	•	•	•	•							
 COMPACT DUCTED* LOW - MED PRESSURE (90Pa)		•	•	•	•	•	•	•								
 DUCTED MEDIUM PRESSURE (200Pa)		•	•	•	•	•	•	•	•	•	•	•	•			
 DUCTED HIGH PRESSURE (300Pa)														•	•	
 DUCTED FRESH AIR												•		•	•	
 CONSOLE		•	•	•	•	•	•									
 FLOOR CONSOLE, BUILT-IN			•	•	•	•	•	•								
 HYDROBOX										•			•			•
 SVP-160A SHUT OFF VALVE BOX		Automatic shut-off valve that isolates only the circuit zone where a refrigerant leak is detected, while maintaining normal operation in the rest of the system. A single SVP box can support up to 5 indoor units with a maximum total capacity of 18 kW.														

*INTERNAL/EXTERNAL EEV AVAILABLE

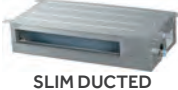
EASY MRV INDOOR RANGE

Residential and Commercial Supermatch Indoor Units - Connectable to MRV Systems with MS Valves. only works with MRV5 and MRV51 and MRV52.

For more information please refer to the Haier Residential and light commercial catalogue

SERIES	REFRIGERANT	2,0 kW	2,5 kW	3,5 kW	4,2 kW	5,0 kW	7,1 kW	10,5 kW	12,5 kW	14,0 kW	16,0 kW
 EXPERT		•	•	•		•	•				
 FLEXIS PLUS		•	•	•	•	•	•				
 CONSOLE			•	•							
 CASSETTE 620			•	•		•					
 SLIM DUCTED LOW PRESSURE			•	•		•	•				
 DUCTED HIGH PRESSURE									•	•	•
 CABINET										•	•

EASY MRV MS Valves for Residential and Commercial Units

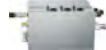
SERIES	11,2 kW	11,2 to 18,0 kW	Max 33,6 kW (max 11,2 kW per single output)
EASY MRV			
Model	MS1-036A	MS1-060A	MS3-036A
Combination with Number of IU	1:1	1:1	1:3
MRV Compatibility	"S" series with front air discharge and "5" series		





NEW **R32**
MRV7S
DC INVERTER

Integrating
Technology
with Solutions

Front Discharge
with R32 Refrigerant

SPECIFICALLY TAILORED FOR THE EUROPEAN MARKET

The new **R32 MRV7 S** system offers a powerful combination of high energy efficiency, innovative design, and a steadfast commitment to safety and environmental responsibility. This system not only enhances operational performance and simplifies installation procedures but also strengthens leak

protection and significantly increases system flexibility. The **MRV7 S** is suitable for a diverse array of applications across vertical markets and is available in **4,5 & 6 HP single fan** and **8,10 & 12HP double fan** both with front discharge.

INTEGRATING DESIGN WITH EFFICIENCY

The introduction of the R32 **MRV7 S** emphasises Haier's dedication to transitioning its MRV range from R410A to R32. This innovative solution positions Haier at the forefront by boosting energy efficiency by up to 17%, implementing advanced safety features to prevent refrigerant leaks, and providing increased flexibility in installation, equipment control, and connectivity.

The **MRV7 S** incorporates a suite of innovative technologies to optimise efficiencies and operational costs. These include a twin rotary compressor, which not only boosts efficiency but also reduces noise. A high efficiency stepless axial fan is engineered to move large volumes of air with minimal power consumption, contributing to sustainability through its robust design.

The **MRV7 S** boasts a scalable and modular architecture, expertly designed to accommodate the specific needs of each individual project. It offers broad compatibility with a variety of indoor unit types, including wall-mounted, cassette, and ducted units, alongside extended pipe lengths up to 400 meters. This allows for highly adaptable configurations that seamlessly integrate with centralised control systems. From compact spaces to expansive infrastructures, the system guarantees customised comfort, without compromising on performance or efficiency.

INTEGRATING SAFETY WITH PRECISION

The **MRV7 S** is engineered with a multi-zone leak detection system, providing comprehensive safety through built-in leak detectors in all our indoor units. The system incorporates visual and audible alarms within the new controllers. For added flexibility, an optional automatic shut-off valve can be installed, supported by a battery-powered emergency function, which is especially useful during power outages. This feature also allows

for zone segregation, enabling the valve to isolate refrigerant and prevent leaks.

These advanced safety protocols are built-in to proactively manage and reduce risks throughout the product's lifecycle, from its initial design to its day-to-day operation, fully compliant with the new EU regulation 573/2024.

INTEGRATING INSTALLATION AND CONTROL FLEXIBILITY

The **MRV7 S** is designed for streamlined installation and maintenance. It incorporates innovative features like Space-Link technology, a novel protocol that provides installers with unparalleled flexibility in wiring the communications network, moving away from the traditional chain method. This results in simplified wiring, faster installation times, and reduced cabling needs. Furthermore, the integrated self-clean functions for both indoor and outdoor units not only ensure cleaner air quality but also minimize the accumulation of dirt and bacteria, thereby extending maintenance intervals.

To further enhance efficiency, the **MRV7 S** features automatic addressing functionality. This simplifies the commissioning process by automatically assigning unique addresses to each indoor unit, eliminating the need for manual configuration. This is

particularly advantageous for larger VRF systems with numerous indoor units, making both installation and commissioning processes more efficient and user-friendly. The new R32 MRV indoor units are all backward compatible with R410A refrigerant, reducing complexity from logistics to installation.

The new controller has been given a communication protocol upgrade, with a smart interface which is compatible with both R32 and R410A indoor units. Integrated with faster communication and zero-latency operation. Furthermore, the system features **AVRA-AI** for intelligent refrigerant control and advanced communication protocols, allowing for faster installation and more precise system control. Each component is meticulously designed to provide practical, real-world solutions.

NEW R32 MRV7S DC INVERTER



INTRODUCING NEW R32 MRV7 S

The New R32 MRV7 S by Haier is the latest generation of VRF systems developed to meet European F-Gas Regulation 573/2024, using low-GWP R32 refrigerant. Specifically designed for the European market, it brings together advanced energy efficiency, cutting edge technology, and a strong commitment to safety and environmental sustainability. This system not only enhances operational performance but also simplifies installation, reinforces leak protection, and ensures adaptability across a multitude of applications including commercial, residential, and hospitality to name a few.

High efficiency DC motor

- DC fan motor with stepless inverter control, from 0 to 91Hz.
- Offering a 17% efficiency improvement over regular DC motors

Axial flow fan

- 640mm axial flow fan
- Reduces the airflow resistance at high speed
- Reduces the noise by 3 dB

Compressor

- Low-Noise, High-Efficiency, Twin-Rotary Inverter Compressor.
- Built-in exhaust noise reduction design, reducing compressor airflow noise
- The compressor adopts new vibration-absorbing materials, combined with rubber damping pads, completely isolating the compressor from the housing, reducing compressor rotational noise and vibrations

Electronic control module

- The variable frequency drive control is designed to use high performance vector control without a position sensor. This achieves a control accuracy of up to 0.01rps, thereby making operation more stable, drives higher efficiencies and ensures best capacity management.
- Refrigeration of PCB for optimal performance of electronic system in hot ambient temperatures

Black Fin - coating

- Better corrosion resistance
- Better defrost performance
- Reduces dirt accumulation
- Improves heat exchange, maximising seasonal efficiency

Refrigerant flow path silencer

- Effectively eliminating refrigerant flow noise

Gas-liquid separator

- Equipped with a larger-sized gas-liquid separator, it ensures a more reliable system operation.

High efficiency oil separator

- Faster and more efficient separation



NEW R32 MRV7 S - FEATURES

R32 LOW GWP

R32 refrigerant has an Ozone Depletion Potential (ODP) of 0 and a Global Warming Potential (GWP) of 675. This means it has no damaging effect on the ozone layer and boasts a 68% lower GWP compared to R410A. The IEC 60335-2-40 regulation introduces new EU safety standards for R32 VRF systems, presenting new design challenges. The R32 MRV7 S front discharge unit is engineered to comply with these standards as well as minimize its carbon footprint.

SIMPLE INDOOR UNIT (IDU) ADDRESSING

The MRV7 S uses automatic addressing mode to set the IDU and ODU (Outdoor Unit) addresses. If the AC system is powered off, the original address will be retained, this solves the pain point of resetting the address after the power failure.

Two options for addressing the indoor units:

- Use the indoor unit's PCB board dip setting addressing **or**
- Use wired controller set the indoor unit addressing



EASY INSTALLATION AND MAINTENANCE

"888" test panel: all running data & errors can be checked from the "888" screen. Rotary switch design for easy set up and faster parameter checking.



Total pipe length is up to 300m (single fan), 400m (double fan) for complete installation flexibility.

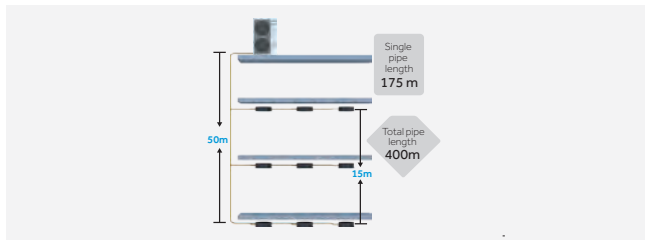

External static pressure is up to 35Pa (single fan), 45Pa (double fan). Unlike a top discharge unit, you do not require an additional ventilation hood.

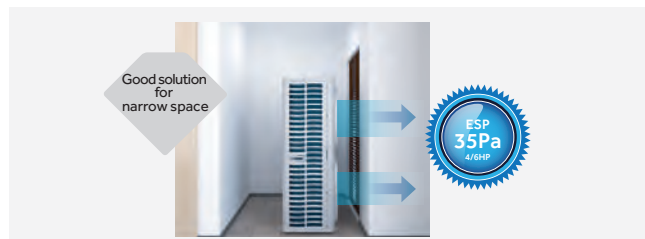

The ODU can be directly connected to a centralised control system without the need for Modbus.

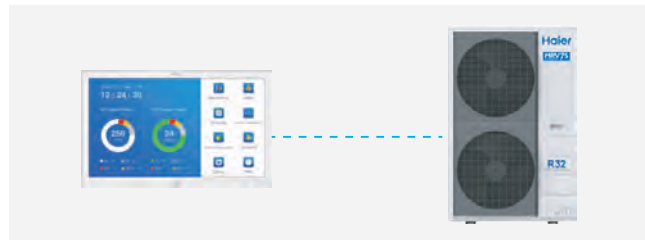

SELF CLEAN TECHNOLOGY

Both indoor and outdoor units benefit from Haier's Self Clean functionality without stopping the compressor and distributing the operation of the unit.

The cold expansion technology forms a layer of frost on the evaporator/condenser which

generates a strong force of cold expansion that easily removes dirt from the surface.

The IDU uses the waste heat of the ODU to defrost the heat exchanger, to dry the condensed water, effectively prevent mold breeding.



The data in this catalogue is purely indicative as the data may vary. Please be advised to check the accuracy of the data with the supplier before purchasing products.

NEW R32 MRV7 S - FEATURES

BUILT-IN R32 LEAK DETECTION WITH SHUT-OFF VALVE

The system is engineered for safety, which automatically detects refrigerant leaks. Upon detection, it activates visual and audible alarms and immediately isolates the affected areas using an automatic shut-off valve.

ODU SHUT-OFF VALVE

Scenario 1: Outdoor unit directly connected to indoor units (without shut off kit).

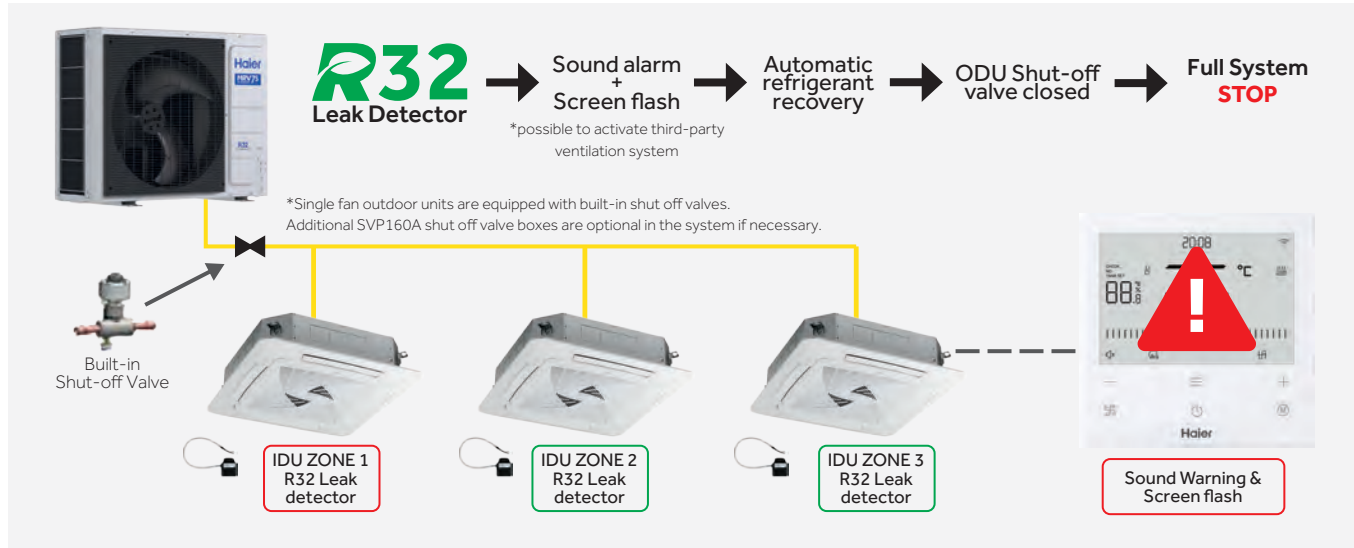

SHUT-OFF VALVE BOX (SVP-160A)

Scenario 2: Outdoor unit connects to VRF indoor unit with shut-off valve kit to allow for localised isolation.



SVP160A is an automatic shut-off valve that isolates only the circuit zone where a refrigerant leak is detected, while maintaining normal operation across the rest of the system. A single SVP box can support **up to 5 indoor units** with a maximum **total indoor capacity of 18 kW**.



For detailed calculations on Shut-off valve applications and other safety measures compliant with IEC 60335-2-40 regulation, refer to the MRV Selection software.

NEW R32 MRV7 S - FEATURES

DIAMOND SHIELD-R32 SAFETY PROTECTION

- **Software:** new version of the MRV selection software calculates the amount of refrigerant in the room and alerts if the safety limit is exceeded.
- **Alarm:** the wired controller, panel and wall-mounted refrigerant detector can trigger a sound and light alarm in the case of a refrigerant leak.
- **Battery:** SVP160A are equipped with a back-up battery, in order to supply power to close the shut off valves in the event of a system power failure.
- **Leak Detectors:** Indoor units are equipped with built in leak detectors. There is no need to replace them after detection.
- **Recovery:** In the case of a leakage, the system can recover the R32 refrigerant to the ODU and will be isolated by the shut off valves (single fan ODU). Unaffected units with SVP160A will continue operation, providing comfortable temperature to the user.
- **Shut off valve:** the 4/5/6 HP MRV7 S outdoor units are equipped with built-in R32 shut off valves.

For the 8/10/12 HP MRV7 S outdoor units, an optional external shut off valve box (SVP160A) can be installed wherever it is necessary.

INTELLIGENT CONTROL MODE

The intelligent control mode enable quick cooling and heating, which increases the compressor output. The double pressure sensor with PID control technology enables temperature control to $\pm 0.5^{\circ}\text{C}$, for optimum indoor air comfort.



IMPROVED EFFICIENCY

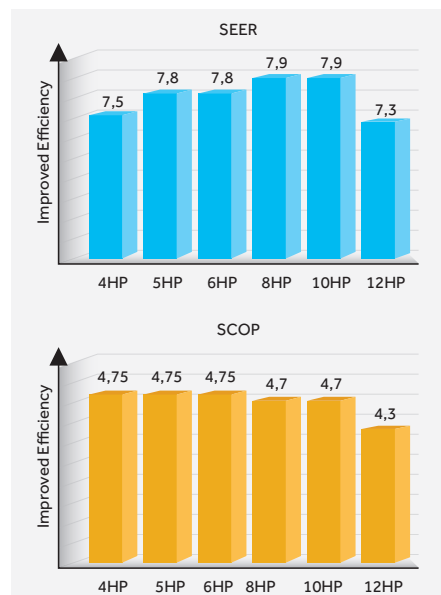

AVRA (ADVANCED VARIABLE REFRIGERANT ADJUSTMENT)

AVRA is an intelligent control technology that dynamically adjusts the refrigerant evaporation temperature based on outdoor ambient temperature and indoor comfort requirements. By simultaneously adjusting the compressor frequency and the electronic expansion valve (EEV) opening, the system can automatically optimise indoor comfort, improve energy efficiency and adapt its performance in real time without requiring any manual intervention.



Outdoor Units With Front Discharge

MRV7 S



4-5-6 HP
Single Phase
 AU042FCFRA
 AU052FCFRA
 AU062FCFRA

Model			AU042FCFRA	AU052FCFRA	AU062FCFRA
Capacity ¹⁾	Power Class	HP	4	5	6
	Cooling	kW	12,10	14,00	15,50
	Heating	kW	12,10	14,00	15,50
Electrical parameters	Power supply	Ph/V/Hz	1 / 220-240 / 50	1 / 220-240 / 50	1 / 220-240 / 50
	Absorbed power - Cooling	kW	3,44	4,12	4,80
	Max. Power Input - Cooling	kW	7,10	7,40	7,70
	Absorbed power - Heating	kW	2,72	3,50	4,08
	Max. Power Input - Heating	kW	6,80	7,10	7,40
	EER energy class	/	3,52	3,40	3,23
	COP energy class	/	4,45	4,00	3,80
	SEER energy class (T1)	/	8,09	7,85	7,62
	SCOP energy class (T1)	/	4,88	4,75	4,71
	Max. external static pressure	Pa	35	35	35
	η _{s,hs,c} %	%	321	311	302
	η _{s,hs,h} %	%	192	187	185
Fan	Air flow (High)	m ³ /h	5800	5800	5800
Pressure sound level	Sound pressure level (Cooling)	dB(A)	54	55	56
	Sound pressure level (Heating)	dB(A)	56	57	58
Dimensions	Unit Dimensions WxDxH	mm	1050x400x840	1050x400x840	1050x400x840
	Packaged unit dimensions WxDxH	mm	1160x520x1015	1160x520x1015	1160x520x1015
Weight	Net/Shipping weight	kg	96	96	96
Compressor	Compressor type	/	Inverter twin rotary	Inverter twin rotary	Inverter twin rotary
	Motor Power	W	4150	4150	4150
	Compressor quantity	/	1	1	1
Refrigerant	Refrigerant type	/	R32	R32	R32
	Pre-charged refrigerant qty.	kg	3,00	3,00	3,00
Piping	Ø Liquid side refrigerant pipe	mm (inch)	9,52 (3/8)	9,52 (3/8)	9,52 (3/8)
	Ø Gas side refrigerant pipe	mm (inch)	19,05 (3/4)	19,05 (3/4)	19,05 (3/4)
	Maximum piping length	m	300	300	300
	Max linear piping length (Equivalent/Real)	m	120	120	120
	Std. drop between IU and OU	m	50/40	50/40	50/40
	Max. drop between IU	m	15	15	15
Connection ratio	Indoor / Outdoor Capacity Ratio	%	50%-150%	50%-150%	50%-150%
	Maximum number of connectable IUs	/	13	16	18
Working temp.	Cooling	°C	-5-52	-5-52	-5-52
	Heating	°C	-25-21	-25-21	-25-21

Indoor temperature (cooling): 27°C DB / 19°C WB, indoor temperature (heating): 20°C DB / 14.5°C WB
 Outdoor temperature (cooling): 35°C DB / 24°C WB, outdoor temperature (heating): 7°C DB / 6°C WB

Outdoor Units With Front Discharge

MRV7 S



4-5-6 HP
 Three Phase
 AU04IFCFRA
 AU05IFCFRA
 AU06IFCFRA

Model			AU04IFCFRA	AU05IFCFRA	AU06IFCFRA
Capacity ^[1]	Power Class	HP	4	5	6
	Cooling	kW	12,10	14,00	15,50
	Heating	kW	12,10	14,00	15,50
Electrical parameters	Power supply	Ph/V/Hz	3 / 380 - 415 / 50	3 / 380 - 415 / 50	3 / 380 - 415 / 50
	Absorbed power - Cooling	kW	3,44	4,12	4,80
	Max, Power Input - Cooling	kW	7,10	7,40	7,70
	Absorbed power - Heating	kW	2,72	3,50	4,08
	Max, Power Input - Heating	kW	6,80	7,10	7,40
	EER energy class	/	3,52	3,40	3,23
	COP energy class	/	4,45	4,00	3,80
	SEER energy class (T1)	/	8,09	7,85	7,62
	SCOP energy class (T1)	/	4,88	4,75	4,71
	Max, external static pressure	Pa	35	35	35
η _{s,hs,c} %	%	321	311	302	
η _{s,hs,h} %	%	192	187	185	
Fan	Air flow (High)	m ³ /h	5800	5800	5800
Pressure sound level	Sound pressure level (Cooling)	dB(A)	54	55	56
	Sound pressure level (Heating)	dB(A)	56	57	58
Dimensions	Unit Dimensions WxDxH	mm	1050x400x840	1050x400x840	1050x400x840
	Packaged unit dimensions WxDxH	mm	1160x520x1015	1160x520x1015	1160x520x1015
Weight	Net/Shipping weight	kg	106	106	106
	Compressor type	/	Inverter twin rotary	Inverter twin rotary	Inverter twin rotary
Compressor	Motor Power	W	4165	4165	4165
	Compressor quantity	/	1	1	1
	Refrigerant type	/	R32	R32	R32
Refrigerant	Pre-charged refrigerant qty,	kg	3,00	3,00	3,00
	Ø Liquid side refrigerant pipe	mm (inch)	9,52 (3/8)	9,52 (3/8)	9,52 (3/8)
Piping	Ø Gas side refrigerant pipe	mm (inch)	19,05 (3/4)	19,05 (3/4)	19,05 (3/4)
	Maximum piping length	m	300	300	300
	Max linear piping length (Equivalent/Real)	m	120	120	120
	Std, drop between IU and OU	m	50/40	50/40	50/40
	Max, drop between IU	m	15	15	15
	Indoor / Outdoor Capacity Ratio	%	50%-150%	50%-150%	50%-150%
Connection ratio	Maximum number of connectable IUs	/	13	16	18
	Working temp,	Cooling	°C	-5-52	-5-52
Heating		°C	-25-21	-25-21	-25-21

Indoor temperature (cooling): 27°C DB / 19°C WB, indoor temperature (heating): 20°C DB / 14.5°C WB
 Outdoor temperature (cooling): 35°C DB / 24°C WB, outdoor temperature (heating): 7°C DB / 6°C WB

The data in this catalogue is purely indicative as the data may vary.
 Please be advised to check the accuracy of the data with the supplier before purchasing products.

Outdoor Units With Front Discharge

MRV7 S



8-10-12 HP
Three Phase
 AU08NFAFRA
 AU10NFAFRA
 AU12NFAFRA

Model			AU08NFAFRA	AU10NFAFRA	AU12NFAFRA
Capacity ¹⁾	Power Class	HP	8	10	12
	Cooling	kW	22,60	28,00	31,50
	Heating	kW	22,60	28,00	31,50
Electrical parameters	Power supply	Ph/V/Hz	3 / 380 - 415 / 50	3 / 380 - 415 / 50	3 / 380 - 415 / 50
	Absorbed power - Cooling	kW	6,95	8,67	11,54
	Max. Power Input - Cooling	kW	11,40	14,30	15,30
	Absorbed power - Heating	kW	5,79	7,37	8,49
	Max. Power Input - Heating	kW	10,80	13,60	14,50
	EER energy class	/	3,25	3,23	2,73
	COP energy class	/	3,90	3,80	3,71
	SEER energy class (T1)	/	7,67	7,65	7,50
	SCOP energy class (T1)	/	4,65	4,60	4,55
	Max. external static pressure	Pa	45	45	45
	η _{s,hs,c} %	%	303,8	303,0	297,0
η _{s,hs,h} %	%	183	181	179	
Fan	Air flow (High)	m ³ /h	12500	12500	12500
Pressure sound level	Sound pressure level (Cooling)	dB(A)	57	59	61
	Sound pressure level (Heating)	dB(A)	60	62	64
Dimensions	Unit Dimensions WxDxH	mm	1050x400x1635	1050x400x1635	1050x400x1635
	Packaged unit dimensions WxDxH	mm	1160x520x1805	1160x520x1805	1160x520x1805
Weight	Net/Shipping weight	kg	165,5	165,5	165,5
Compressor	Compressor type	/	Inverter twin rotary	Inverter twin rotary	Inverter twin rotary
	Motor Power	W	6890	6890	6890
	Compressor quantity	/	1	1	1
Refrigerant	Refrigerant type	/	R32	R32	R32
	Pre-charged refrigerant qty.	kg	6,50	6,50	6,50
Piping	Ø Liquid side refrigerant pipe	mm (inch)	12,70 (1/2)	12,70 (1/2)	12,70 (1/2)
	Ø Gas side refrigerant pipe	mm (inch)	19,05 (3/4)	19,05 (3/4)	19,05 (3/4)
	Maximum piping length	m	400	400	400
	Max linear piping length (Equivalent/Real)	m	150	150	150
	Std. drop between IU and OU	m	50/40	50/40	50/40
	Max. drop between IU	m	15	15	15
Connection ratio	Indoor / Outdoor Capacity Ratio	%	50%~150%	50%~150%	50%~150%
	Maximum number of connectable IUs	/	20	25	30
Working temp.	Cooling	°C	-5-52	-5-52	-5-52
	Heating	°C	-25-21	-25-21	-25-21

Indoor temperature (cooling): 27°C DB / 19°C WB, indoor temperature (heating): 20°C DB / 14.5°C WB
 Outdoor temperature (cooling): 35°C DB / 24°C WB, outdoor temperature (heating): 7°C DB / 6°C WB

Outdoor Units With Front Discharge MRV7 S

AU042FCFRA AU052FCFRA AU062FCFRA AU041FCFRA AU051FCFRA AU061FCFRA

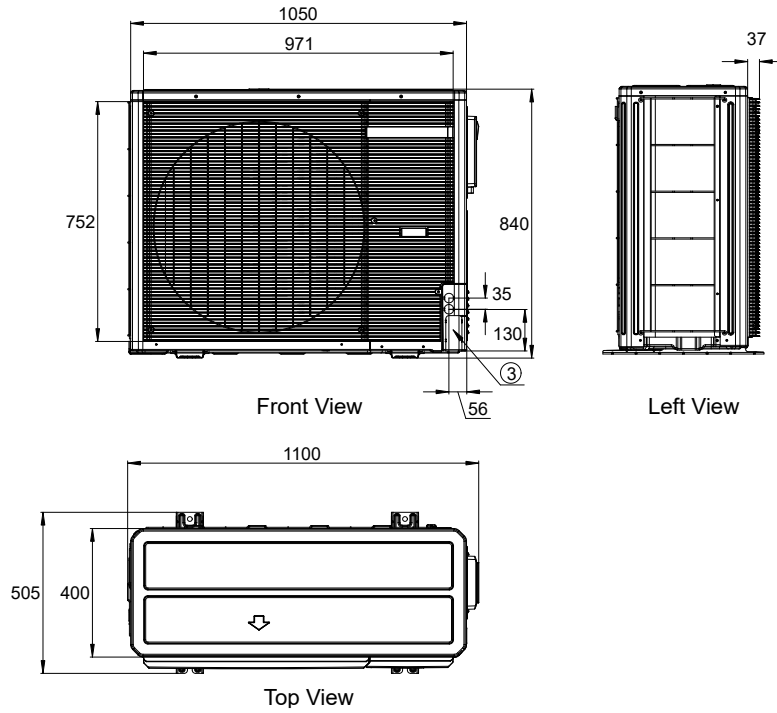

AU08NFAFRA AU10NFAFRA AU12NFAFRA

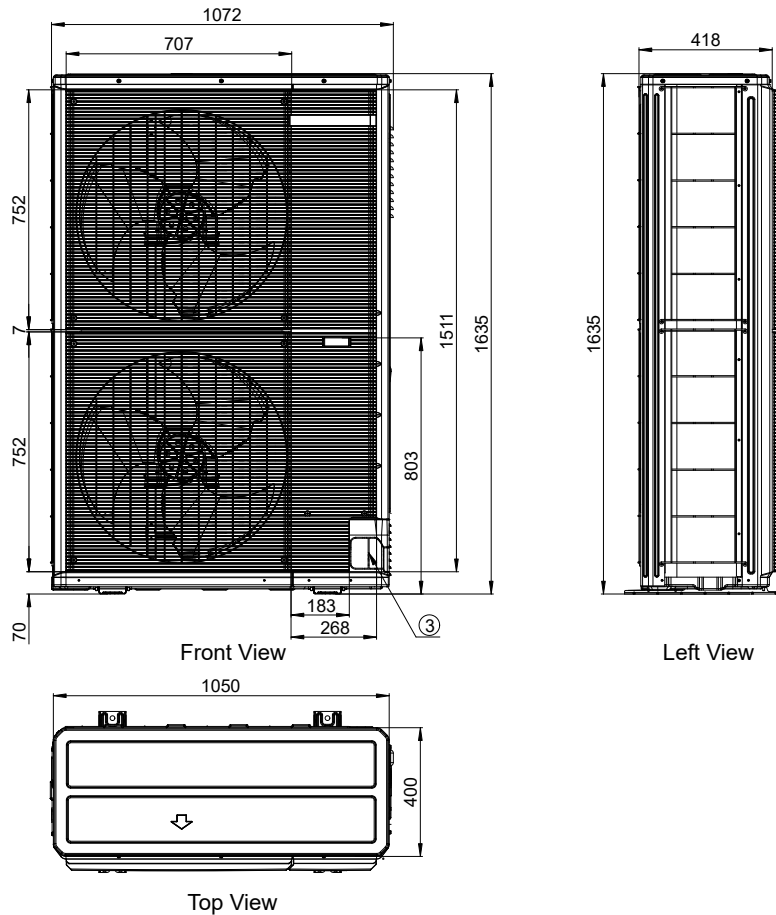

NEW R32 MRV7 S - ACCESSORIES

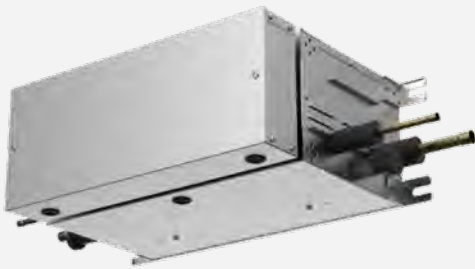

SVP-160A SHUT-OFF VALVE BOX

Automatic shut-off valve only isolates the circuit zone where a refrigerant leak is detected, while maintaining normal operation across the rest of the system. A single SVP box can support up to 5 indoor units with a maximum total capacity of 18kW.

Name		Parameter
Max. Power / Max. number of IDU		18kW / 5 units
Power supply	Ph/V/Hz	1 / 220 - 240 / 50
Recommended circuit breaker		6 A
Liquid connection diameter		Ø9.52 (3/8)
Liquid connection diameter		Ø15.88 (5/8)

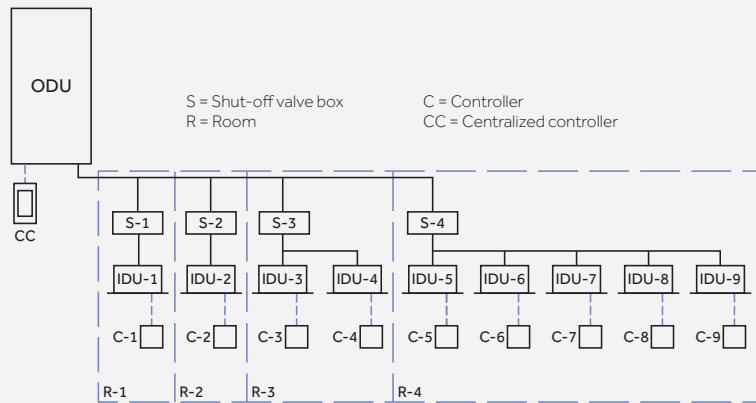
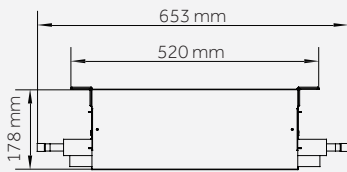
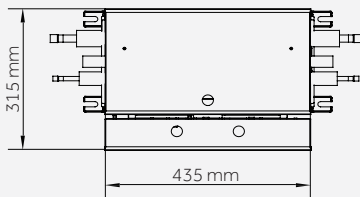

HDEC-R32A EXTERNAL R32 LEAK DETECTOR

An external R32 leak detector for MRV7 S systems, providing additional protection alongside the built-in detectors in all our indoor units, ensuring safety and compliance.

Name		Parameter
Main Specifications	External dimension	110*90*33mm
	Shell	PC+ABS flame retardant plastic
	Range	0-100%xLFL
R32	Resolution	0.1%LFL
	Rated supply voltage	24 V
Rated power		2 W
Operating temperature range		-30 - 80 °C
Operating humidity range		20 - 95 %



HA-AA110AD COMMUNICATIONS AMPLIFIER

The amplifier/repeater boosts and cleans the signal to prevent quality loss over long cables, enabling longer network transmission distances while keeping the space-link features. It supports up to 2 repeaters per system and 30 indoor units. Repeaters extend the signal range for larger setups or distances exceeding 200 meters, thus making max. space-link communication distance with repeaters of 600m.

Name		Parameter
Dimensions		283*168*74mm
Rated power		AC 220V-240V, 50Hz

MRV S^{II}

DC Inverter Unit
with Front Discharge

MRV S II - FEATURES

IMPROVED CONFIGURATION AND PERFORMANCE (8/10/12HP FRONT DISCHARGE)

Flexible applications with bigger outdoor capacity options.

High efficiency DC fan motor

- DC fan motor with stepless inverter control, increases efficiency by 45% comparing with AC motor.

Larger fan diameter

- Ø570mm larger axial flow fan
- Zigzag design, reduces disturbance in airflow as well as increasing air volume and reducing noise level.

High efficiency condenser

- Newly designed high efficiency inner grooved tube.
- New hydrophilic corrugated fissurefin increases efficiency.



Vector inverter control

- 180 degrees sine wave vector control, 64-bit operation
- Precision control achieves high efficiency and lower noise levels

Double pressure sensor

- Equipped with high and low voltage pressure sensors
- Accurate pressure control ensures the system runs smoothly, increasing energy efficiency.

Twin rotary DC Inverter compressor

- High chamber DC inverter twin rotary compressor
- Increased energy efficiency by achieving smaller vibrations and benefiting from lower sound levels.

LEADING TECHNOLOGY (4-6HP)

Two-stage super cooling cycle technology, increases efficiency by 9%. (Double fan) 30°C maximum temperature in cooling increases unit refrigerating capacity by 46%



INCREASING POWERFUL HEATING CAPACITY

When the ambient temperature is low, the heat exchange capability of the outdoor unit is decreased and the amount of air returned by the compressor is reduced. By increasing the refrigerant flow during the heating cycle of the indoor unit heat exchanger, we improve the heating capacity.

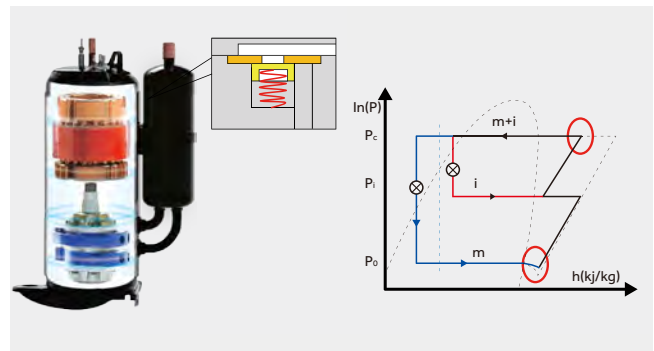

MRV S II - FEATURES

HIGH EER AND COP(8/10/12HP)

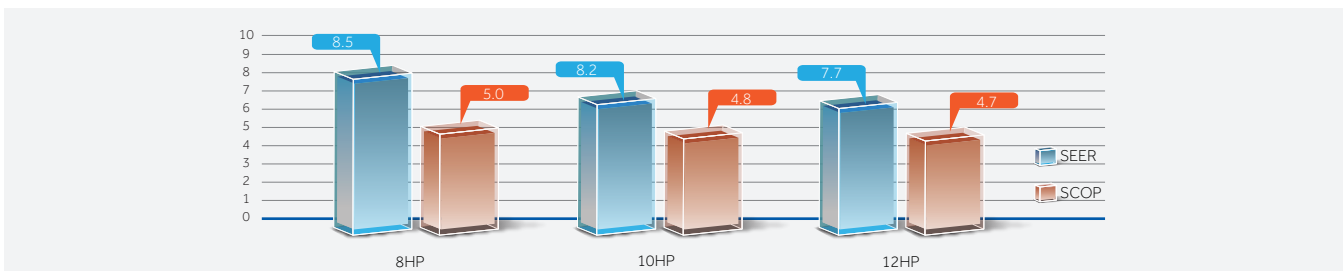

DC FAN AND FAN MOTOR

- DC inverter fan motor is highly efficient during part load operation
- 16-stage speed control; high efficiency operation especially in low speed

- 45% increase in efficiency compared with AC motor due to reduced input power
- 570mm diameter fan, increases air flow and achieves higher efficiency(8/10/12HP)

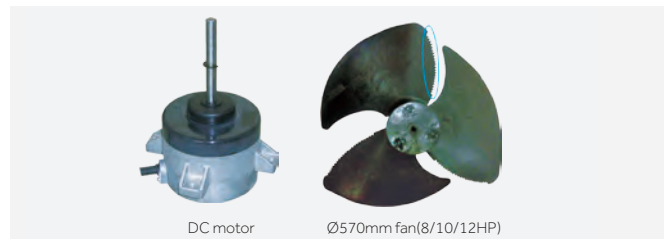
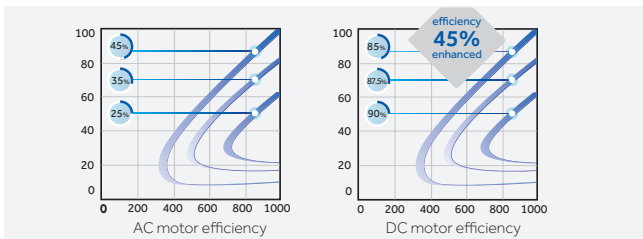

SELF-CLEANING FUNCTION ON INDOOR AND OUTDOOR UNITS

During operation, dirt accumulates on the evaporator. If the evaporator is not cleaned regularly, accumulated dirt reduces the thermal exchange by 15-30% and also promotes the proliferation of bacteria and mould.

The new Self Clean technology is the first of its kind to integrate the self-cleaning function of both the evaporator and the condenser. It starts with cleaning the evaporator, then switches to cleaning the condenser without stopping the compressor.

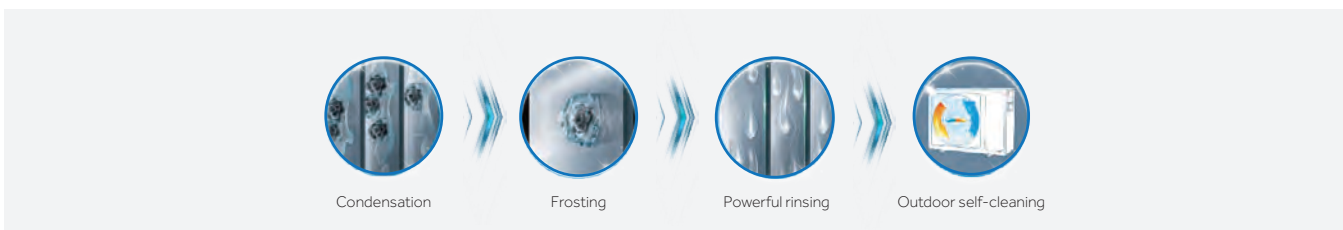

LOW NOISE LEVEL

- Night quiet operation function
- Noise levels can be reduced down to 45dB(A)

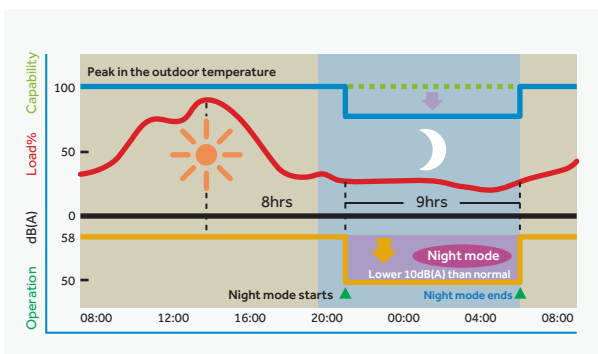

NEW DC INVERTER TWIN ROTARY COMPRESSOR

- A small torque change and a good dynamic balance of the system allows the unit to run smoothly with little vibration, low noise levels and increased efficiency
- Increased efficiency during part load operation

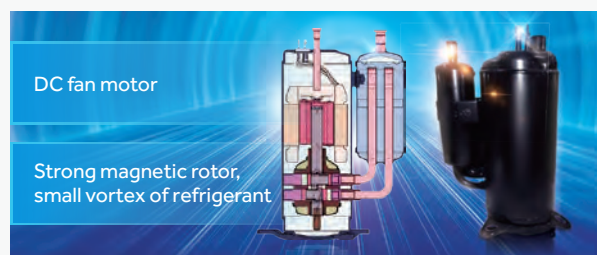

MRV S II - FEATURES

- 1** New aerodynamic fan
550mm super big diameter aerospace helix fan. lowering sound level by 3dB(A)
- 2** Enlarged air inlet path and spiral air outlet path.
Air flow direction follows the grill direction which reduces sound levels by 2-4 dB(A)
- 3** Automatic sound reduction capability. Night mode set by the PCB is 8dB(A) lower

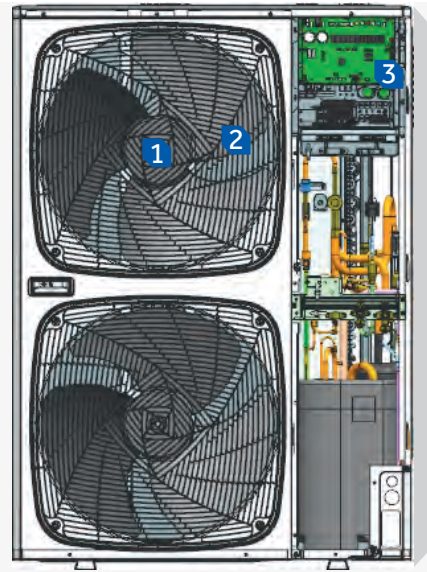

LOW SOUND OPERATION

- DC inverter compressor achieves a smoother operation and effectively reduces sound levels by eliminating the frequent start up of the compressor.
- Precision control achieved by vector inverter control
- Non-resonance motor brackets are used on the DC fan motor which ensures a smoother operation of the motor and reduces operating sound levels
- Larger fan diameter inspired by aviation design principles for quieter operation



COMPACT FRONT DISCHARGE DESIGN

Front discharge design eliminates the need for additional ventilation hood compared with a top discharge unit, ideal for narrow spaces.



MRV S II - FEATURES

LONG PIPE LENGTH, INCREASED HEIGHT DROP

- Total pipe length: 300m
- Single pipe length: Max.175m
- From outdoor to the first branch pipe: 135m
- From the first branch to the furthest indoor door unit: 40m
- Height drop: 50m(outdoor above)/40m (outdoor below)
- Height drop between indoor units: 15m



PARAMETER DISPLAY PANEL

The parameter display panel has been improved by moving it to the side of the unit. The parameter can be easily accessed by directly opening the protective cover for maintenance.

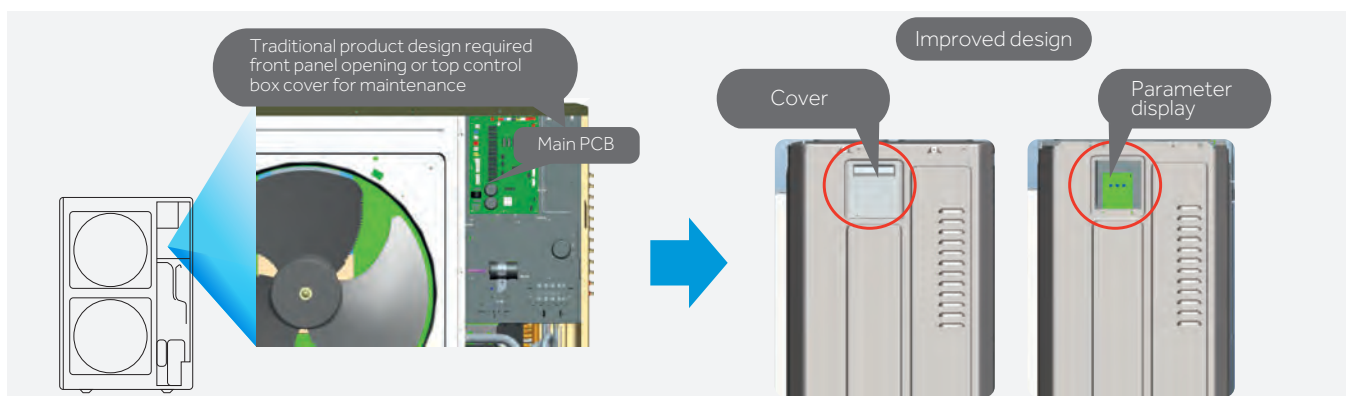

AUTOMATIC REFRIGERANT RECLAIM TECHNOLOGY

Set automatic refrigerant reclaim through the dip switch. The refrigerant in the indoor unit can be automatically returned to the outdoor unit. This is convenient during maintenance, reducing refrigerant waste, maintenance cost and time.

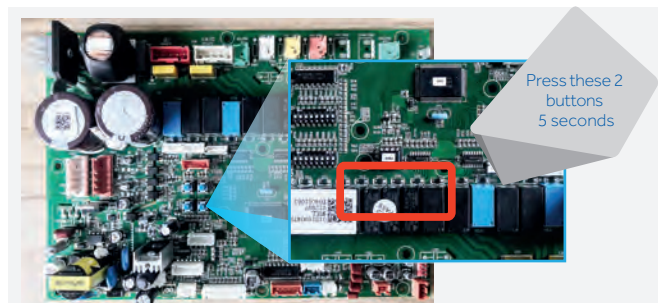

REFRIGERANT CONTROL TECHNOLOGY

Refrigerant control technology without high pressure accumulator, reduces the refrigerant volume and enhances operating efficiency.

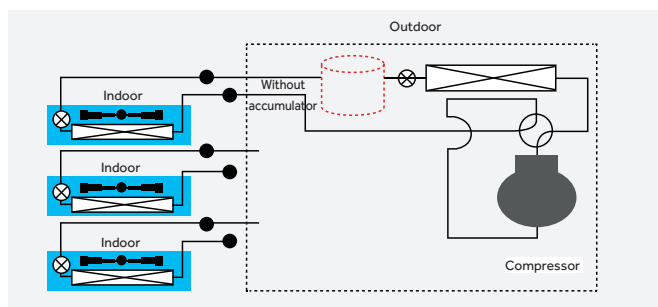

HIGH AND LOW DOUBLE PRESSURE SENSOR

- Double pressure sensor with PID control technology.
- Combining high speed communication to quick start the compressor with more precise control the temperature can be controlled with a precision of $\pm 0.5^{\circ}\text{C}$.



Outdoor Units with Front Discharge MRV S II



4-5 HP
AU042FNERA
AU052FNERA

Model			AU042FNERA	AU052FNERA
Capacity ^[1]	Power Class	HP	4	5
	Cooling	kW	12,10	14,00
	Heating	kW	12,10	14,00
Electrical parameters	Power supply	Ph/V/Hz	1/220-240/50/60	1/220-240/50/60
	Absorbed power - Cooling	kW	4,25	4,83
	Max absorbed current - Cooling	A	28,30	29,30
	Absorbed power - Heating	kW	4,10	5,00
	Max absorbed current - Heating	A	27,90	29,30
	EER energy class	/	2,85	2,80
	COP energy class	/	2,95	2,90
	SEER energy class (T1)	/	4,90	4,85
	SCOP energy class (T1)	/	3,50	3,55
	η _{s,hs,c} %	%	193	191
η _{s,hs,h} %	%	137	139	
Fan	Air flow (High)	m ³ /h	5400	5400
Pressure sound level	Sound pressure level (Cooling)	dB(A)	58	60
	Sound pressure level (Heating)	dB(A)	60	62
Dimensions	Unit Dimensions WxDxH	mm	950x370x965	950x370x965
	Packaged unit dimensions WxDxH	mm	1010x458x990	1010x458x990
Weight	Net/Shipping weight	kg	90/102	90/102
Compressor	Compressor type	/	Rotary Inverter	Rotary Inverter
	Motor Power	W	4130	4130
	Compressor quantity	/	1	1
Refrigerant	Refrigerant type	/	R410A	R410A
	Pre-charged refrigerant qty.	kg	3,30	3,30
Piping	Ø Liquid side refrigerant pipe	mm (inch)	9,52 (3/8)	9,52 (3/8)
	Ø Gas side refrigerant pipe	mm (inch)	15,88 (5/8)	15,88 (5/8)
	Maximum piping length	m	120	120
	Max linear piping length (Equivalent/Real)	m	70/60	70/60
	Std. drop between IU and OU	m	30/20	30/20
	Max. drop between IU *3	m	10	10
Connection ratio	Indoor / Outdoor Capacity Ratio	%	50-130	50-130
	Maximum number of connectable IUs	/	7	8
Working temp.	Cooling	°C	-5-50	-5-50
	Heating	°C	-15-21	-15-21

(*) The specifications indicated are obtained with the following test conditions: in Cooling mode, Indoor temperature of 27°C DB / 19°C WB and Outdoor temperature of 35°C DB / 24°C WB. In Heating mode, Indoor temperature of 20°C WB and Outdoor temperature of 7°C DB / 6°C WB

Outdoor Units with Front Discharge

MRV S II



4-6HP

- AU042FPERA
- AU052FPERA
- AU062FPERA
- AU041FPERA
- AU051FPERA
- AU061FPERA

Model			AU042FPERA	AU052FPERA	AU062FPERA	AU041FPERA	AU051FPERA	AU061FPERA
Capacity ^[1]	Power Class	HP	4	5	6	4	5	6
	Cooling	kW	12,10	14,00	15,50	12,10	14,00	15,50
	Heating	kW	12,10	14,00	15,50	12,10	14,00	15,50
Electrical parameters	Power supply	Ph/V/Hz	1/220-240/50/60	1/220-240/50/60	1/220-240/50/60	3/380-415/50/60	3/380-415/50/60	3/380-415/50/60
	Absorbed power - Cooling	kW	3,61	4,33	5,17	3,61	4,33	5,17
	Max absorbed current - Cooling	A	34,10	35,50	36,90	11,40	11,90	12,90
	Absorbed power - Heating	kW	3,23	3,76	5,00	3,23	3,76	5,00
	Max absorbed current - Heating	A	32,70	34,10	35,50	10,90	11,40	11,90
	EER energy class	/	3,35	3,23	3,00	3,35	3,23	3,00
	COP energy class	/	3,75	3,72	3,10	3,75	3,72	3,10
	SEER energy class (T1)	/	6,82	6,65	6,80	6,82	6,65	6,80
	SCOP energy class (T1)	/	4,05	4,11	4,05	4,05	4,11	4,05
	ηs,h %	%	270	263	269	270	263	269
ηs,h %	%	159	161	159	159	161	159	
Fan	Air flow (High)	m ³ /h	7200	7200	7200	7200	7200	7200
Pressure sound level	Sound pressure level (Cooling)	dB(A)	57	58	59	57	58	59
	Sound pressure level (Heating)	dB(A)	57	58	59	57	58	59
Dimensions	Unit Dimensions WxDxH	mm	950x370x1350	950x370x1350	950x370x1350	950x370x1350	950x370x1350	950x370x1350
	Packaged unit dimensions WxDxH	mm	1023x471x1420	1023x471x1420	1023x471x1420	1023x471x1420	1023x471x1420	1023x471x1420
Weight	Net/Shipping weight	kg	108/123	108/123	108/123	108/123	108/123	108/123
	Compressor type	/	Rotary Inverter	Rotary Inverter	Rotary Inverter	Rotary Inverter	Rotary Inverter	Rotary Inverter
Compressor	Motor Power	W	4130	4130	4130	4060	4060	4060
	Compressor quantity	/	1	1	1	1	1	1
Refrigerant	Refrigerant type	/	R410A	R410A	R410A	R410A	R410A	R410A
	Pre-charged refrigerant qty.	kg	4,00	4,00	4,00	4,00	4,00	4,00
Piping	Ø Liquid side refrigerant pipe	mm (inch)	9,52 (3/8)	9,52 (3/8)	9,52 (3/8)	9,52 (3/8)	9,52 (3/8)	9,52 (3/8)
	Ø Gas side refrigerant pipe	mm (inch)	15,88 (5/8)	15,88 (5/8)	15,88 (5/8)	15,88 (5/8)	15,88 (5/8)	15,88 (5/8)
	Maximum piping length	m	300	300	300	300	300	300
	Max linear piping length (Equivalent/Real)	m	175/150	175/150	175/150	175/150	175/150	175/150
	Std. drop between IU and OU	m	50	50	50	50	50	50
	Max. drop between IU *3	m	15	15	15	15	15	15
Connection ratio	Indoor / Outdoor Capacity Ratio	%	50-130	50-130	50-130	50-130	50-130	50-130
	Maximum number of connectable IUs	/	8	10	13	8	10	13
Working temp.	Cooling	°C	-5-50	-5-50	-5-50	-5-50	-5-50	-5-50
	Heating	°C	-20-27	-20-27	-20-27	-20-27	-20-27	-20-27

(*) The specifications indicated are obtained with the following test conditions: in Cooling mode, Indoor temperature of 27°C DB / 19°C WB and Outdoor temperature of 35°C DB / 24°C WB. In Heating mode, Indoor temperature of 20°C WB and Outdoor temperature of 7°C DB / 6°C WB

(a) With solder reduced from 22,22 to 19,05 for connecting the pipe to the unit valve accessory accompanying the product.

(b) The unit also works regularly with 9,52 diameter pipe. Requires 9,52>12,7 adapter to connect to the machine (not provided by Haier).

Outdoor Units with Front Discharge MRV S II



8-12HP

AU08NFKERA
AU10NFKERA
AU12NFKERA

Model			AU08NFKERA	AU10NFKERA	AU12NFKERA
Capacity ¹⁾	Power Class	HP	8	10	12
	Cooling	kW	22,60	28,00	31,50
	Heating	kW	22,60	30,50	31,50
Electrical parameters	Power supply	Ph/V/Hz	3/380-415/50/60	3/380-415/50/60	3/380-415/50/60
	Absorbed power - Cooling	kW	6,95	8,67	11,54
	Max absorbed current - Cooling	A	19,00	23,80	25,40
	Absorbed power - Heating	kW	5,79	8,03	8,49
	Max absorbed current - Heating	A	18,00	22,60	24,20
	EER energy class	/	3,25	3,23	2,73
	COP energy class	/	3,90	3,80	3,71
	SEER energy class (T1)	/	7,67	7,65	7,47
	SCOP energy class (T1)	/	4,05	4,16	4,21
	η _{s,h} %	%	304	303	296
η _{s,h} %	%	159	163	165	
Fan	Air flow (High)	m ³ /h	10000	10000	10000
Pressure sound level	Sound pressure level (Cooling)	dB(A)	63	64	65
	Sound pressure level (Heating)	dB(A)	65	66	67
Dimensions	Unit Dimensions WxDxH	mm	1050x400x1636	1050x400x1636	1050x400x1636
	Packaged unit dimensions WxDxH	mm	1150x510x1790	1150x510x1790	1150x510x1790
Weight	Net/Shipping weight	kg	149/168	149/168	149/168
Compressor	Compressor type	/	Twin Rotary Inverter	Twin Rotary Inverter	Twin Rotary Inverter
	Motor Power	W	6270	6270	6270
	Compressor quantity	/	1	1	1
Refrigerant	Refrigerant type	/	R410A	R410A	R410A
	Pre-charged refrigerant qty.	kg	5,10	5,10	5,10
Piping	Ø Liquid side refrigerant pipe	mm (inch)	9,52 (3/8)	9,52 (3/8)	12,7 (1/2)
	Ø Gas side refrigerant pipe	mm (inch)	19,05 (3/4)	22,22 (7/8)	25,40 (1)
	MaMaximum piping length	m	300	300	300
	Max linear piping length (Equivalent/Real)	m	175/150	175/150	175/150
	Std. drop between IU and OU	m	50	50	50
	StMax. drop between IU *3	m	15	15	15
Connection ratio	Indoor / Outdoor Capacity Ratio	%	50-130	50-130	50-130
	Maximum number of connectable IUs	/	13	16	19
Working temp.	Cooling	°C	-5~48	-5~48	-5~48
	Heating	°C	-20~27	-20~27	-20~27

(*) The specifications indicated are obtained with the following test conditions: in Cooling mode, Indoor temperature of 27°C DB / 19°C WB and Outdoor temperature of 35°C DB / 24°C WB. In Heating mode, Indoor temperature of 20°C WB and Outdoor temperature of 7°C DB / 6°C WB

Outdoor Units with Front Discharge

MRV S II

AU042FNERA AU052FNERA

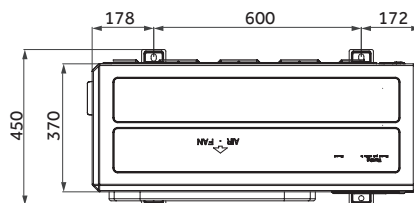
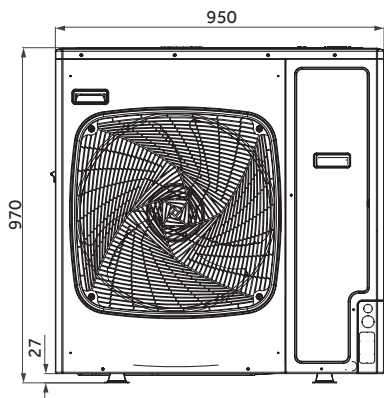

AU042FPERA AU052FPERA AU062FPERA AU04IFPERA AU05IFPERA AU06IFPERA

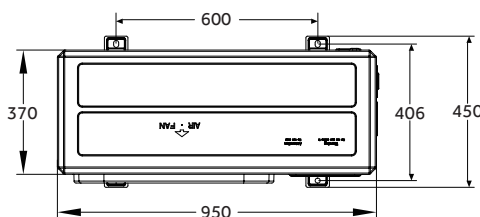
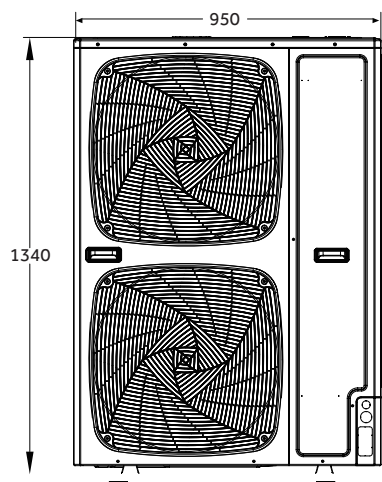

AU08NFKERA AU10NFKERA AU12NFKERA

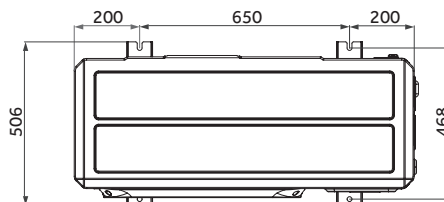
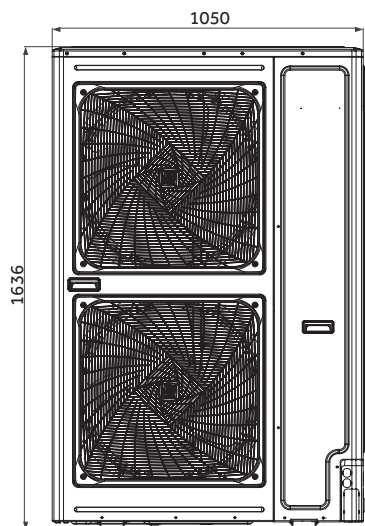



MRV5-H

DC INVERTER

Heat Pump
VRF Continuous
Heating System

MRV5-H

DC INVERTER



MRV 5-H CONTINUOUS HEATING, EVEN DURING DEFROST MODE.

MRV 5-H continuous heating VRF system by Haier adopts intelligent defrost technology according to the system pressure, coil temperature and humidity changes, coupled with the fan motor inspection technology to initiate automatic defrost mode.

Indoor temperature fluctuations are reduced by using direct defrosting technology and ensuring that in certain defrosting modes the four-way valve does not reverse direction giving you uninterrupted heating temperatures.



MRV5-H

DC INVERTER

ENHANCED VAPOR INJECTION TECHNOLOGY, LOW TEMPERATURE HEATING AND HIGH TEMPERATURE COOLING

The MRV 5-H unit adopts an EVI compressor, which can increase the circulation of the refrigerant by 15%, and improve the heating effect by 30% compared with standard compressor types. The heating operating temperature in winter can be -27°C , and the cooling operating temperature in summer can be 52°C .

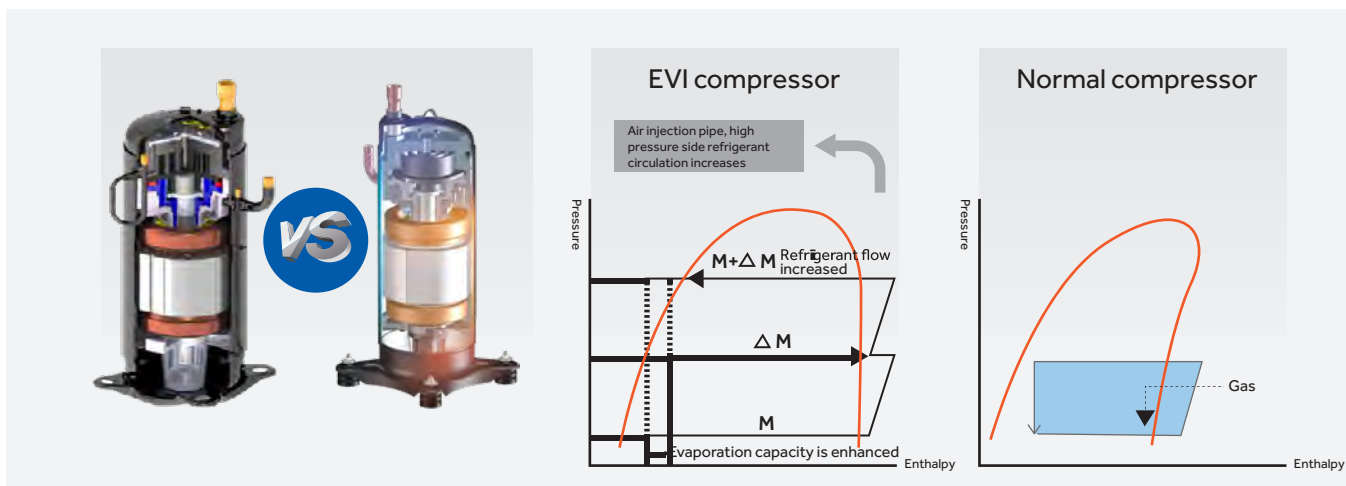

2 STAGE SUB-COOLING

Sub-cooling degree is up to 30°C . improves the cooling and heating capacity.

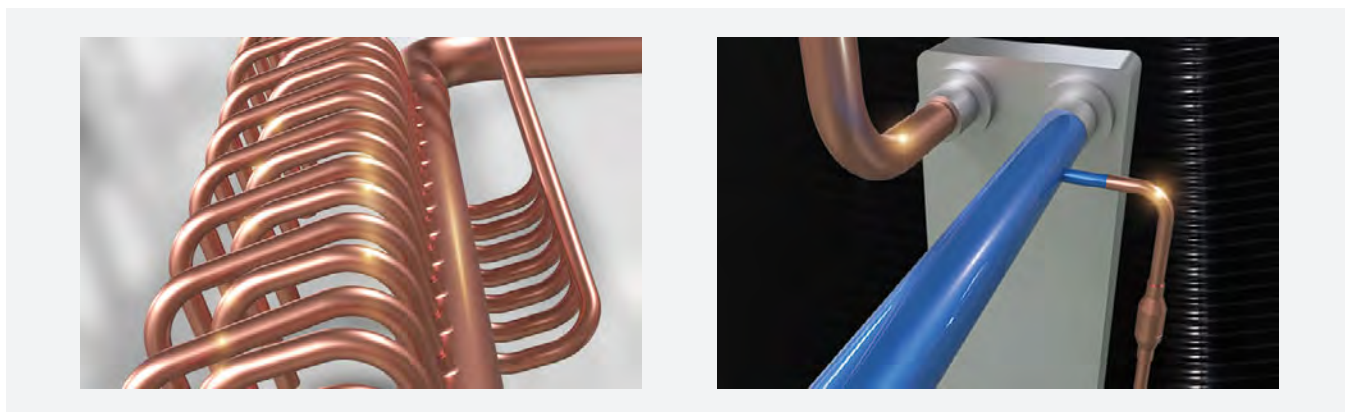

RELIABLE PERFORMANCE IN LOW TEMPERATURES

Compared with the standard series, the heating capacity in MRV 5-H is increased by 10% in the low temperature. For example, in the 8HP unit the heating capacity is 100% under -10°C environment temperature.

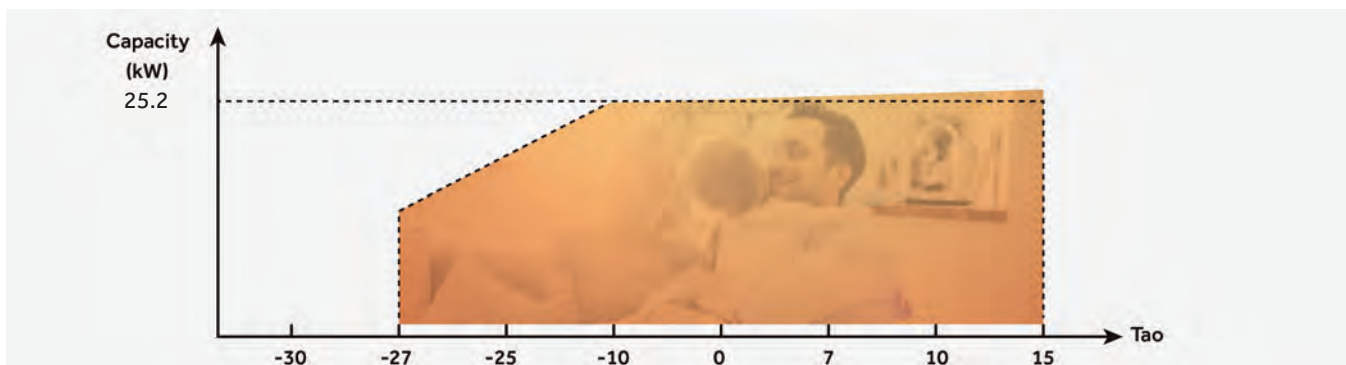

MRV5-H

DC INVERTER

WIDE RANGE OF POWER

Up to 26 HP with single module and up to 104 HP by combining up to 4 modules. Modules 8 to 16 HP are equipped with single fan, for maximum installation flexibility and a small footprint on the surface.



SMART LINK

Wireless connection and communication between indoor units.

- Labour saving
- Automatic network connection
- Convenient maintenance
- Stable performance
- Total Cost saving is estimated about 30%



TOTAL PIPE LENGTH 1000M, HEIGHT DROP 110M

- Max. total pipe length 1000m
- Max. actual pipe length 220m
- Max. equivalent pipe length 260m
- Max. drop between IDU&ODU / 90m (outdoor unit up) / 110m (outdoor unit down)
- Max. drop between IDU&IDU 30m*

* if the total pipe length is between 300m and 1100m or the drop between IDU and ODU more than 50m, please contact your local dealer.

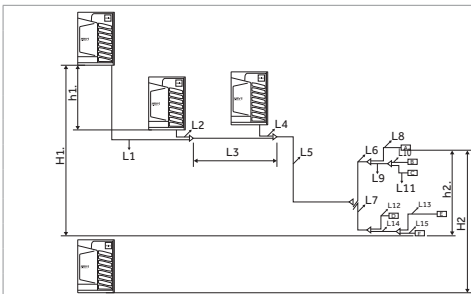
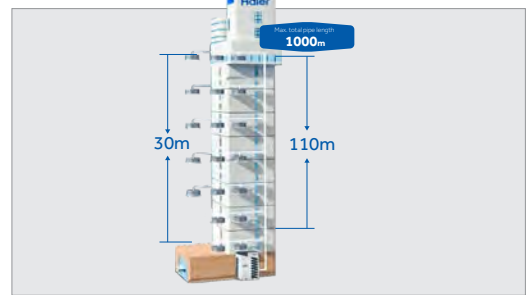

	Max. Length	Pipe in left figure	
Single way total pipe length (=total liquid pipe length)	1000m	L1+L2+L3+L4+L5+L6+L7+L8 + L9+L10+L11+L12+L13+L14+L15	
Single way max. pipe length (max. length between outdoor & indoor) actual length	220m	L1 + L3 + L5 + L7 + L14 + L13	
Main pipe actual length (length between first gather pipe & first branch pipe)	130m	L5	
Pipe length after first branch pipe (length between first branch & farthest indoor)	90m	L7+L13+L14	
The distance between the nearest indoor unit and the farthest indoor	40m	L13+L14-L12	
Pipe length among outdoor units (length between first gather pipe & farthest outdoor unit)	10m	L1+L3	
Height difference between indoors	18	h2	
Height difference between outdoors	5m	h1	
Height difference between indoor & outdoor	Indoor below outdoor (between highest outdoor & lowest indoor)	50m	H1
	Indoor above outdoor (between lowest outdoor & highest indoor)	40m	H2

MRV5-H

DC INVERTER

DESIGN OF CONTROL CONDENSER WITH ELECTRONIC EXPANSION VALVE

The condenser is controlled by two electronic expansion valves, which can reasonably use the heat exchanger area according to the demand of IDU heat exchange temperature and distribute the refrigerant flow according to the load demand, to ensure high-performance heat exchange efficiency.

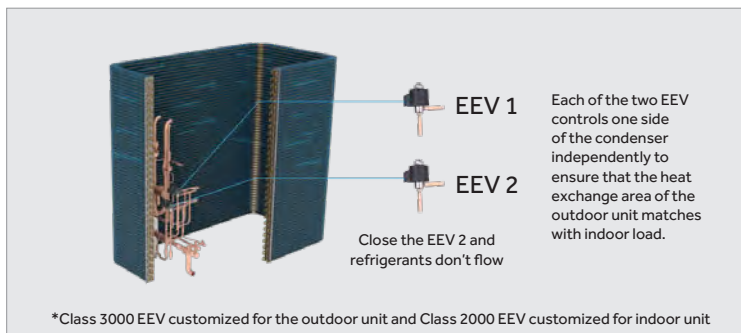

SUPER EFFICIENCY WITH FULL DC INVERTER COMPRESSOR

Matches up inverter with stepless compressor, the durability and stability of the compressor are guaranteed, fault can be reduced.

Each compressor has an inbuilt oil temperature sensor and a discharge temperature sensor, detecting the discharge temperature and oil temperature of compressor, which in coordination with the compressor frequency and the EEV control, to ensure exhaust heat and oil temperature superheat kept within the optimal range. Ensure that the oil dilution is maintained at a safe level at all times.

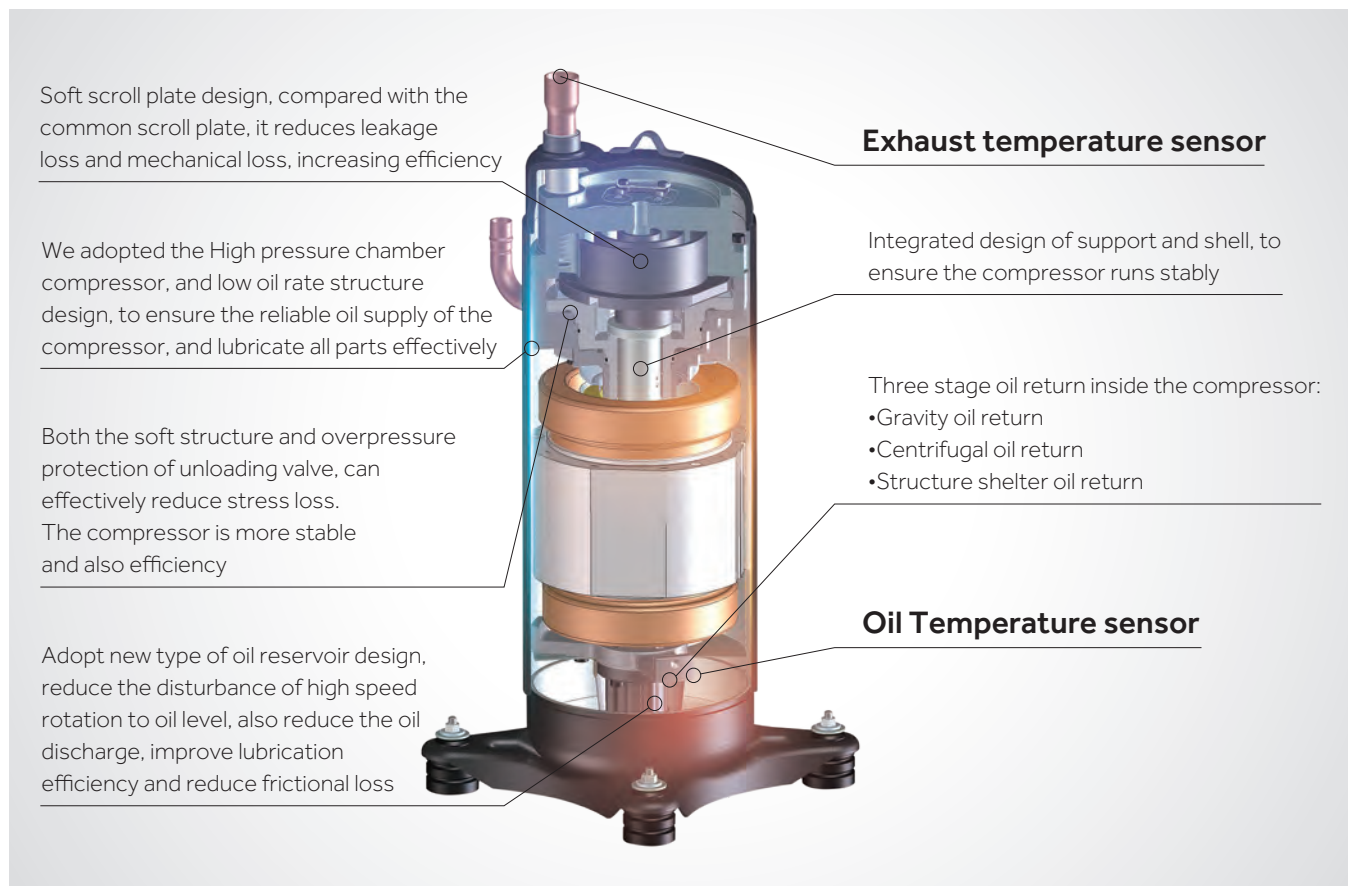

MRV5-H

DC INVERTER

AUTOMATIC OIL BALANCING

When pairing multiple modules with each other, it is not necessary to provide the oil equalisation pipe, as the lubrication system inside each module is self-controlled.



4-SIDED CONTINUOUS HEAT EXCHANGER COIL

The outdoor unit adopts a 4-sided continuous heat exchanger coil design, increasing the heat exchange area and airflow efficiency. This results in up to 30% higher heat exchange efficiency compared to conventional 3-sided designs. The system works with a high-efficiency variable-speed DC motor and stepless fan frequency control (0-91 Hz) for optimized performance and reduced energy consumption.



CERTIFIED AND REGISTERED DESIGN

The unit is equipped with a hinged technical door that allows access to the electronic parts in a simple and secure way. The electronic part in turn is mounted on a mobile base that can also be opened for access to the refrigeration part of the unit. This line of products includes new and generous fans with an aerodynamic profile tested in the wind tunnel, with a diameter of 700 mm to move large air flows in maximum tranquillity and quietness.



TEMPERATURE APPROACHING TECHNOLOGY

The main problem of an ordinary inverter VRF system lies in that its compressor starts and stops frequently, stopping when the room temperature reaches the setting temperature and restarting when the same becomes higher than the setting temperature. Though the inverter technology has improved such a problem greatly, the energy consumption caused by system restart is still a problem that cannot be ignored. Haier MRV 5 series units adopts the temperature approaching technology, which enables the VRF system to maintain a low-frequency operating state all the time when the room temperature is close to the setting temperature but doesn't reach the setting temperature, thus avoiding the energy waste caused by frequent on/off.

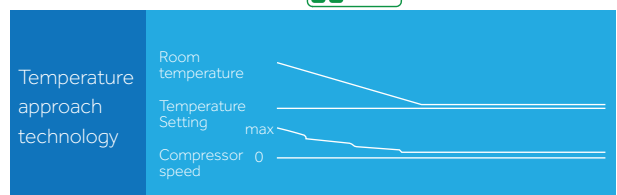
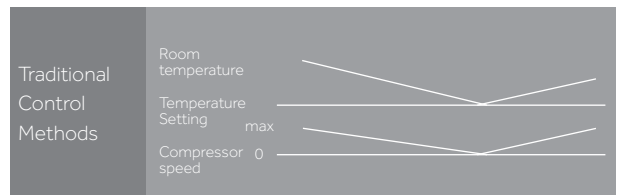

MRV5-H

DC INVERTER

WIDE OPERATION TEMPERATURE

The heating operation temperature can be as low as -23°C outdoor ambient temperature. The cooling operation temperature can reach 50°C outdoor temperature, allowing it to operate in extreme temperatures.



PRECISE TEMPERATURE CONTROL AT ±0.5°C

With twin pressure sensors and twin EEVS, the refrigerant volume can be adjusted automatically to realise precise temperature control, improving indoor comfort.

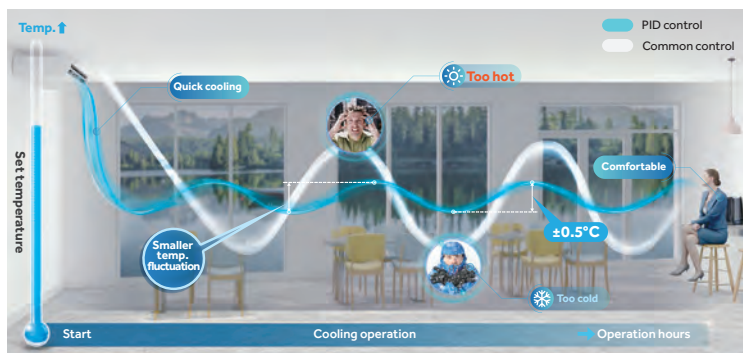

INTELLIGENT TRIPLE BACKUP OPERATION TECHNOLOGY

- For the double-compressor system, if one compressor is in breakdown, the other compressor can be put into backup operation immediately to ensure the user needs.
- For the multi-module combination, in case of breakdown of one outdoor unit, this unit can be interrupted from the system so that the other modules can continue to operate.
- Super-long backup operation time, which can reach up to 8 hours.



MULTIPLE MODES AVAILABLE TO MEET THE NEEDS OF DIFFERENT USERS



Operation mode:
Cooling priority, heating priority, cooling only, heating only, and VIP priority



Silent mode:
Seven-position silent mode available (night time silent mode and six-position silent mode)



Static pressure mode:
No static pressure mode, low static pressure mode, medium static pressure mode, and high static pressure mode

MRV5-H

DC INVERTER

ROTARY ELECTRIC CONTROL BOX DESIGN

Rotary electric control box design gives access to the inside of the machine without having to dismantle the whole casing, for faster and more convenient maintenance.



AUTOMATIC SNOW CLEARING AND DUST REMOVAL FUNCTION

According to the ash accumulation on the outdoor heat exchanger, the unit will blow away the dust, according to the reverse operation of the fan.



AUTO ADDRESSING INDOOR UNITS

The ODU can automatically address the indoor units through the module on PCB, and the controller can search and set the address of the indoor unit, making the setup and maintenance of the system quick and easy.

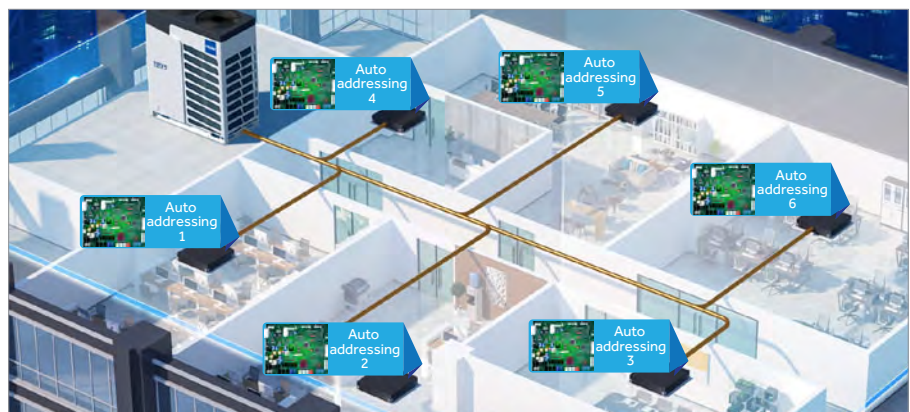

110PA EXTERNAL STATIC PRESSURE DESIGN

The static pressure of the air outlet is up to 110Pa, which can meet the cooling effect of the layered arrangement of the outdoor unit.



Installation of duct



The outdoor unit is hidden inside the building without affecting the overall image of the building

4-WAY PIPE CONNECTION

You can freely choose the front, back, left side, right side of the unit to connect the pipe, easy for install and design.



PIPING REFRIGERANT STORAGE TECHNOLOGY

Advanced refrigerant control technology, the refrigerant is stored in the indoor and outdoor machine piping, remove the high pressure tank, less refrigerant filling in unit, high efficiency.



MRV5-H

DC INVERTER

SMARTLINK - WIRELESS WI-FI COMMUNICATION

Wi-Fi "Smartlink", the new and exclusive wireless communication system between outdoor and indoor units (optional)



"SMARTLINK" WI-FI FEATURES

- As an alternative to the classic digital communication cable, which is required to make all indoor units talk to their outdoor units, you can install these wireless radio accessories with ZigBee technology on each indoor and outdoor unit.
- At the time of activation, the indoor units begin to dialog with each other creating a stable network of coded signals that bounce between the various internal units until they reach the outdoor unit and vice versa. Each indoor unit works as a signal repeater. With this system, communication is guaranteed even to the most distant indoor unit, and in the presence of walls or other obstacles.
- When an indoor unit is in maintenance, the signal of the unit is lost, this does not affect the normal functioning of the other units.
- The system is set up by the Haier service centres in the start-up phase through a special application (APP) that can be installed on smartphones or tablets (it does not require access to the Internet, as it works on a local WIFI network)



Radio adapter for the indoor unit to be connected to the respective electronic board.

The use of the 'Smartlink' system is useful where it is impossible to reach all the units with a cable. It can be expensive in economic terms and takes time to roll out a cable, intervening on an existing redevelopment plant where the existing layout of the wired communication is not known and where there was a problem on the existing cable (damage etc.) and it is not possible to detect the problem.



8-16HP

AV08NMVETA
AV10NMVETA
AV12NMVETA
AV14NMVETA
AV16NMVETA

Model		AV08NMVETA	AV10NMVETA	AV12NMVETA	AV14NMVETA	AV16NMVETA
Capacity						
Power Class	HP	8	10	12	14	16
Cooling	kW	25.20	28.00	33.50	40.00	45.00
Heating	kW	25.20	28.00	33.50	40.00	45.00
Electrical Parameters						
Power supply	Ph/V/Hz	*3/380-400/50/60 (5 wires L1+L2+L3+N+T)*		*3/380-400/50/60 (5 wires L1+L2+L3+N+T)*		*3/380-400/50/60 (5 wires L1+L2+L3+N+T)*
Absorbed power - Cooling	kW	6.24	7.37	10.15	11.76	13.24
Max absorbed power - Cooling	kW	14.30	15.10	16.32	17.58	20.69
Absorbed current in cooling	A	10.53	12.44	17.14	19.85	22.34
Max absorbed current - Cooling	A	23.81	25.14	27.17	29.27	34.50
Absorbed power - Heating	kW	5.25	5.96	8.59	10.00	10.47
Max absorbed power - Heating	kW	11.69	12.19	12.69	16.10	19.56
Absorbed current in heating	A	8.86	10.06	14.50	16.88	17.67
Max absorbed current - Heating	A	19.47	20.30	21.13	26.81	32.57
EER energy class	W/W	4.04	3.80	3.30	3.40	3.40
COP energy class	W/W	4.80	4.70	3.90	4.00	4.30
SEER energy class	W/W	7.25	7.09	6.69	6.60	6.36
SCOP energy class	W/W	4.41	4.31	4.31	4.10	3.92
ηs,c %		287	281	265	261	251
ηs,h %		173	169	169	161	153
Ventilation						
Air flow (High)	m³/h	11000	11000	12000	13500	13500
Sound pressure level (High)	dB(A)	56	56	59	59	60
Sound power level (High)	dB(A)	81	82	88	88	88
Installation - Dimensions - Components						
Unit Dimensions WxDxH	mm	980x750x1690				
Packaged unit dimensions WxDxH	mm	1070x850x1858				
Net weight / Gross weight	Kg	255/280				
Compressor type		DC Inverter Scroll	DC Inverter Scroll	DC Inverter Scroll	DC Inverter Scroll	DC Inverter Scroll
Quantity and type of the compressor	No.	1INV	1INV	1INV	1INV	1INV
Refrigerant type		R410A	R410A	R410A	R410A	R410A
Pre-charged refrigerant qty.	Kg	10	10	10	10	10
Ø Liquid side refrigerant pipe	mm (inch)	9.52 (3/8)	9.52 (3/8)	12.70 (1/2)	12.70 (1/2)	12.70 (1/2)
Ø Gas side refrigerant pipe	mm (inch)	19.05 (3/4)	22.22 (7/8)	25.40 (1)	25.40 (1)	28.58 (1-1/8)
Maximum piping length	m	1000	1000	1000	1000	1000
Max linear piping length (Equivalent/Real)	m	260/220	260/220	260/220	260/220	260/220
Max. drop between IU and OU (O.U. down/up)*1	m	110/90	110/90	110/90	110/90	110/90
Max. drop between IU and OU (O.U. down/up)*2	m	50/40	50/40	50/40	50/40	50/40
Max. drop between IU *3	m	30	30	30	30	30
Std. drop between IU *4	m	18	18	18	18	18
Static Pressure Fans	Pa	110	110	110	110	110
Connectable Indoor Capacity Ratio						
Indoor / Outdoor Capacity Ratio	%	50-130	50-130	50-130	50-130	50-130
Maximum number of connectable IUs	No.	13	16	20	24	27
External Temperature Operating Limits						
Cooling	°C	-5-52	-5-52	-5-52	-5-52	-5-52
Heating	°C	-27-21	-27-21	-27-21	-27-21	-27-21

Outdoor Units

MRV5-H

DC INVERTER



18-26HP

- AV18NMVETA
- AV20NMVETA
- AV22NMVETA
- AV24NMVETA
- AV26NMVETA

		AV18NMVETA	AV20NMVETA	AV22NMVETA	AV24NMVETA	AV26NMVETA
Capacity						
Power Class	HP	18	20	22	24	26
Cooling	kW	50,40	56,00	61,50	68,00	73,50
Heating	kW	50,40	56,00	61,50	68,00	73,50
Electrical Parameters						
Power supply	Ph/V/Hz	"3/380-400/50/60 (5 wires L1+L2+L3+N+T)"		"3/380-400/50/60 (5 wires L1+L2+L3+N+T)"		"3/380-400/50/60 (5 wires L1+L2+L3+N+T)"
Absorbed power - Cooling	kW	15,60	16,62	20,16	22,67	27,22
Max absorbed power - Cooling	kW	25,90	28,91	31,82	32,81	37,80
Absorbed current in cooling	A	26,34	28,05	34,04	38,27	45,95
Max absorbed current - Cooling	A	40,30	46,30	51,91	54,12	61,91
Absorbed power - Heating	kW	13,19	14,66	18,64	19,43	22,97
Max absorbed power - Heating	kW	21,93	24,70	25,69	30,40	32,45
Absorbed current in heating	A	22,27	24,75	31,46	32,80	38,78
Max absorbed current - Heating	A	36,51	41,13	42,78	50,62	54,03
EER energy class	W/W	3,23	3,37	3,05	3,00	2,70
COP energy class	W/W	3,82	3,82	3,30	3,50	3,20
SEER energy class	W/W	6,78	6,75	6,54	5,83	5,15
SCOP energy class	W/W	4,15	4,20	4,21	4,17	3,50
$\eta_{s,c}$ %		268	267	259	230	203
$\eta_{s,h}$ %		163	165	165	164	137
Ventilation						
Air flow (High)	m ³ /h	17000	17000	18000	18000	19000
Sound pressure level (High)	dB(A)	61	61	61	62	62
Sound power level (High)	dB(A)	88	88	90	90	90
Installation - Dimensions - Components						
Unit Dimensions WxDxH	mm	1410x750x1690				
Packaged unit dimensions WxDxH	mm	1515x850x1858				
Net weight / Gross weight	Kg	385/410				
Compressor type		DC Inverter Scroll	DC Inverter Scroll	DC Inverter Scroll	DC Inverter Scroll	DC Inverter Scroll
Quantity and type of the compressor	No.	2INV	2INV	2INV	2INV	2INV
Refrigerant type		R410A	R410A	R410A	R410A	R410A
Pre-charged refrigerant qty.	Kg	10	10	10	10	10
Ø Liquid side refrigerant pipe	mm (inch)	15,88 (5/8)	15,88 (5/8)	15,88 (5/8)	15,88 (5/8)	15,88 (5/8)
Ø Gas side refrigerant pipe	mm (inch)	28,58 (1-1/8)	28,58 (1-1/8)	28,58 (1-1/8)	28,58 (1-1/8)	28,58 (1-1/8)
Maximum piping length	m	1000	1000	1000	1000	1000
Max linear piping length (Equivalent/Real)	m	260/220	260/220	260/220	260/220	260/220
Max. drop between IU and OU (O.U. down/up)*1	m	110/90	110/90	110/90	110/90	110/90
Max. drop between IU and OU (O.U. down/up)*2	m	50/40	50/40	50/40	50/40	50/40
Max. drop between IU *3	m	30	30	30	30	30
Std. drop between IU *4	m	18	18	18	18	18
Static Pressure Fans	Pa	110	110	110	110	110
Connectable Indoor Capacity Ratio						
Indoor / Outdoor Capacity Ratio	%	50-130	50-130	50-130	50-130	50-130
Maximum number of connectable IUs	No.	30	33	36	40	43
External Temperature Operating Limits						
Cooling	°C	-5-52	-5-52	-5-52	-5-52	-5-52
Heating	°C	-27-21	-27-21	-27-21	-27-21	-27-21

The data in this catalogue is purely indicative as the data may vary.
Please be advised to check the accuracy of the data with the supplier before purchasing products.



28-32 HP

AV14NMVETA

AV16NMVETA

Model		AV28NMVETA AV14NMVETA AV14NMVETA	AV30NMVETA AV14NMVETA AV16NMVETA	AV32NMVETA AV16NMVETA AV16NMVETA
Capacity				
Power Class	HP	28	30	32
Cooling	kW	80,00	85,00	90,00
Heating	kW	80,00	85,00	90,00
Electrical Parameters				
Power supply	Ph/V/Hz	"3/380-400/50/60 (5 wires L1+L2+L3+N+T)"	"3/380-400/50/60 (5 wires L1+L2+L3+N+T)"	"3/380-400/50/60 (5 wires L1+L2+L3+N+T)"
Absorbed power - Cooling	kW	23,53	25,00	26,47
Max absorbed power - Cooling	kW	35,16	38,27	41,38
Absorbed current in cooling	A	39,72	42,21	44,69
Max absorbed current - Cooling	A	58,54	63,77	69,00
Absorbed power - Heating	kW	20,00	20,47	20,93
Max absorbed power - Heating	kW	32,20	35,66	39,12
Absorbed current in heating	A	33,76	34,55	35,33
Max absorbed current - Heating	A	53,61	59,38	65,14
EER energy class	W/W	3,40	3,40	3,40
COP energy class	W/W	4,00	4,15	4,30
SEER energy class	W/W	6,60	6,36	6,36
SCOP energy class	W/W	4,12	4,05	4,05
η _{s,c} %		261	251	251
η _{s,h} %		162	159	159
Ventilation				
Air flow (High)	m ³ /h	27000	27000	27000
Sound pressure level (High)	dB(A)	62	62,5	63
Sound power level (High)	dB(A)	91	91	91
Installation - Dimensions - Components				
Unit Dimensions WxDxH	mm	980x750x1690+980x750x1690		
Packaged unit dimensions WxDxH	mm	1070x850x1858+1070x850x1858		
Net weight / Gross weight	Kg	255/280+255/280		
Compressor type		DC Inverter Scroll	DC Inverter Scroll	DC Inverter Scroll
Quantity and type of the compressor	No.	2INV	2INV	2INV
Refrigerant type		R410A	R410A	R410A
Pre-charged refrigerant qty.	Kg	20	20	20
Ø Liquid side refrigerant pipe	mm (inch)	15,88 (5/8)	19,05 (3/4)	19,05 (3/4)
Ø Gas side refrigerant pipe	mm (inch)	28,58 (1-1/8)	31,80 (1-1/4)	31,80 (1-1/4)
Maximum piping length	m	1000	1000	1000
Max linear piping length (Equivalent/Real)	m	260/220	260/220	260/220
Max. drop between IU and OU (O.U. down/up)*1	m	110/90	110/90	110/90
Max. drop between IU and OU (O.U. down/up)*2	m	50/40	50/40	50/40
Max. drop between IU *3	m	30	30	30
Std. drop between IU *4	m	18	18	18
Static Pressure Fans	Pa	110	110	110
Connectable Indoor Capacity Ratio				
Indoor / Outdoor Capacity Ratio	%	50-130	50-130	50-130
Maximum number of connectable IUs	No.	47	50	53
External Temperature Operating Limits				
Cooling	°C	-5-52	-5-52	-5-52
Heating	°C	-27-21	-27-21	-27-21

Outdoor Units

MRV5-H DC INVERTER

Haier

34-38HP

AV14NMVETA

AV18NMVETA

AV20NMVETA



Model		AV34NMVETA AV16NMVETA AV16NMVETA	AV36NMVETA AV18NMVETA AV18NMVETA	AV38NMVETA AV18NMVETA AV20NMVETA
Capacity				
Power Class	HP	34	36	38
Cooling	kW	95,40	100,80	106,40
Heating	kW	95,40	100,80	106,40
Electrical Parameters				
Power supply	Ph/V/Hz	"3/380-400/50/60 (5 wires L1+L2+L3+N+T)"	"3/380-400/50/60 (5 wires L1+L2+L3+N+T)"	"3/380-400/50/60 (5 wires L1+L2+L3+N+T)"
Absorbed power - Cooling	kW	28,84	31,21	32,22
Max absorbed power - Cooling	kW	46,59	51,80	54,81
Absorbed current in cooling	A	48,69	52,67	54,40
Max absorbed current - Cooling	A	74,80	80,60	86,60
Absorbed power - Heating	kW	23,66	26,39	27,85
Max absorbed power - Heating	kW	41,49	43,86	46,63
Absorbed current in heating	A	39,94	44,55	47,02
Max absorbed current - Heating	A	69,08	73,03	77,64
EER energy class	W/W	3,31	3,23	3,30
COP energy class	W/W	4,03	3,82	3,82
SEER energy class	W/W	6,36	6,78	6,75
SCOP energy class	W/W	4,05	4,15	4,15
ηs,c %		251	268	267
ηs,h %		159	163	163
Ventilation				
Air flow (High)	m ³ /h	27000	34000	34000
Sound pressure level (High)	dB(A)	63,5	64	64
Sound power level (High)	dB(A)	91	91	91
Installation - Dimensions - Components				
Unit Dimensions WxDxH	mm	980x750x1690+1410x750x1690	1410x750x1690+1410x750x1690	
Packaged unit dimensions WxDxH	mm	1070x850x1858+1485x850x1858	1485x850x1858+1485x850x1858	
Net weight / Gross weight	Kg	255/280+385/410	385/410+385/410	
Compressor type		DC Inverter Scroll	DC Inverter Scroll	DC Inverter Scroll
Quantity and type of the compressor	No.	3INV	4INV	4INV
Refrigerant type		R410A	R410A	R410A
Pre-charged refrigerant qty.	Kg	20	20	20
Ø Liquid side refrigerant pipe	mm (inch)	19,05 (3/4)	19,05 (3/4)	19,05 (3/4)
Ø Gas side refrigerant pipe	mm (inch)	31,80 (1-1/4)	38,10 (1-1/2)	38,10 (1-1/2)
Maximum piping length	m	1000	1000	1000
Max linear piping length (Equivalent/Real)	m	260/220	260/220	260/220
Max. drop between IU and OU (O.U. down/up)*1	m	110/90	110/90	110/90
Max. drop between IU and OU (O.U. down/up)*2	m	50/40	50/40	50/40
Max. drop between IU *3	m	30	30	30
Std. drop between IU *4	m	18	18	18
Static Pressure Fans	Pa	110	110	110
Connectable Indoor Capacity Ratio				
Indoor / Outdoor Capacity Ratio	%	50-130	50-130	50-130
Maximum number of connectable IUs	No.	56	59	63
External Temperature Operating Limits				
Cooling	°C	-5-52	-5-52	-5-52
Heating	°C	-27-21	-27-21	-27-21

The data in this catalogue is purely indicative as the data may vary.
Please be advised to check the accuracy of the data with the supplier before purchasing products.



40-48HP

AV20NMVETA

AV22NMVETA

AV24NMVETA

Model		AV40NMVETA AV20NMVETA AV20NMVETA	AV42NMVETA AV20NMVETA AV22NMVETA	AV44NMVETA AV22NMVETA AV22NMVETA	AV46NMVETA AV22NMVETA AV24NMVETA	AV48NMVETA AV24NMVETA AV24NMVETA
Capacity						
Power Class	HP	40	42	44	46	48
Cooling	kW	112,00	117,50	123,00	129,50	136,00
Heating	kW	112,00	117,50	123,00	129,50	136,00
Electrical Parameters						
Power supply	Ph/V/Hz	"3/380-400/50/60 (5 wires L1+L2+L3+N+T)"		"3/380-400/50/60 (5 wires L1+L2+L3+N+T)"		"3/380-400/50/60 (5 wires L1+L2+L3+N+T)"
Absorbed power - Cooling	kW	33,23	36,78	40,33	42,83	45,33
Max absorbed power - Cooling	kW	57,82	60,73	63,64	64,63	65,62
Absorbed current in cooling.	A	56,11	62,09	68,08	72,31	76,53
Max absorbed current - Cooling	A	92,60	98,21	103,82	106,03	108,24
Absorbed power - Heating	kW	29,32	33,30	37,27	38,06	38,86
Max absorbed power - Heating	kW	49,40	50,39	51,38	56,09	60,80
Absorbed current in heating	A	49,50	56,21	62,92	64,26	65,60
Max absorbed current - Heating	A	82,25	83,90	85,55	93,39	101,23
EER energy class	W/W	3,37	3,19	3,05	3,02	3,00
COP energy class	W/W	3,82	3,53	3,30	3,40	3,50
SEER energy class	W/W	6,75	6,54	6,54	5,83	5,83
SCOP energy class	W/W	4,20	4,20	4,21	4,17	4,17
ηs,c %		267	259	259	230	230
ηs,h %		165	165	165	164	164
Ventilation						
Air flow (High)	m³/h	34000	35000	36000	36000	36000
Sound pressure level (High)	dB(A)	64	64	64	64,5	65
Sound power level (High)	dB(A)	91	92	93	93	93
Installation - Dimensions - Components						
Unit Dimensions WxDxH	mm	1410x750x1690+1410x750x1690				
Packaged unit dimensions WxDxH	mm	1485x850x1858+1485x850x1858				
Net weight / Gross weight	Kg	385/410+385/410				
Compressor type		DC Inverter Scroll	DC Inverter Scroll	DC Inverter Scroll	DC Inverter Scroll	DC Inverter Scroll
Quantity and type of the compressor	No.	4INV	4INV	4INV	4INV	4INV
Refrigerant type		R410A	R410A	R410A	R410A	R410A
Pre-charged refrigerant qty.	Kg	20	20	20	20	20
Ø Liquid side refrigerant pipe	mm (inch)	19,05 (3/4)	19,05 (3/4)	19,05 (3/4)	19,05 (3/4)	19,05 (3/4)
Ø Gas side refrigerant pipe	mm (inch)	38,10 (1-1/2)	38,10 (1-1/2)	38,10 (1-1/2)	38,10 (1-1/2)	38,10 (1-1/2)
Maximum piping length	m	1000	1000	1000	1000	1000
Max linear piping length (Equivalent/Real)	m	260/220	260/220	260/220	260/220	260/220
Standard height difference between IU and OU	m	110/90	110/90	110/90	110/90	110/90
Standard height difference between IU and IU	m	50/40	50/40	50/40	50/40	50/40
Max. drop between IU *3	m	30	30	30	30	30
Std. drop between IU *4		18	18	18	18	18
Static Pressure Fans	Pa	110	110	110	110	110
Connectable Indoor Capacity Ratio						
Indoor / Outdoor Capacity Ratio	%	50-130	50-130	50-130	50-130	50-130
Maximum number of connectable IUs	No.	64	64	64	64	64
External Temperature Operating Limits						
Cooling	°C	-5-52	-5-52	-5-52	-5-52	-5-52
Heating	°C	-27-21	-27-21	-27-21	-27-21	-27-21

Outdoor Units

MRV5-H DC INVERTER

50-56HP

- AV18NMVETA
- AV20NMVETA
- AV24NMVETA
- AV26NMVETA



Model		AV50NMVETA AV24NMVETA AV26NMVETA	AV52NMVETA AV26NMVETA AV26NMVETA	AV54NMVETA AV18NMVETA AV18NMVETA AV18NMVETA	AV56NMVETA AV18NMVETA AV18NMVETA AV20NMVETA
Capacity					
Power Class	HP	50	52	54	56
Cooling	kW	141.50	147.00	151.20	156.80
Heating	kW	141.50	147.00	151.20	156.80
Electrical Parameters					
Power supply	Ph/V/Hz	"3/380-400/50/60 (5 wires L1+L2+L3+N+T)"	"3/380-400/50/60 (5 wires L1+L2+L3+N+T)"	"3/380-400/50/60 (5 wires L1+L2+L3+N+T)"	"3/380-400/50/60 (5 wires L1+L2+L3+N+T)"
Absorbed power - Cooling	kW	49.89	54.44	46.81	47.82
Max absorbed power - Cooling	kW	70.61	75.60	77.70	80.71
Absorbed current in cooling.	A	84.22	91.91	79.03	80.74
Max absorbed current - Cooling	A	116.03	123.82	120.90	126.90
Absorbed power - Heating	kW	42.40	45.94	39.58	41.05
Max absorbed power - Heating	kW	62.85	64.90	65.79	68.56
Absorbed current in heating	A	71.58	77.55	66.82	69.30
Max absorbed current - Heating	A	104.65	108.06	109.54	114.15
EER energy class	W/W	2.84	2.70	3.23	3.28
COP energy class	W/W	3.34	3.20	3.82	3.82
SEER energy class	W/W	5.15	5.15	6.78	6.75
SCOP energy class	W/W	3.50	3.50	4.15	4.15
$\eta_{s,c}$ %		193	193	268	267
$\eta_{s,h}$ %		137	137	163	163
Ventilation					
Air flow (High)	m ³ /h	37000	38000	51000	51000
Sound pressure level (High)	dB(A)	65	65	65.8	65.8
Sound power level (High)	dB(A)	93	93	93	93
Installation - Dimensions - Components					
Unit Dimensions WxDxH	mm	1410x750x1690+1410x750x1690		1410x750x1690+1410x750x1690+1410x750x1690	
Packaged unit dimensions WxDxH	mm	1485x850x1858+1485x850x1858		1485x850x1858+1485x850x1858+1485x850x1858	
Net weight / Gross weight	Kg	385/410+385/410		385/410+385/410+385/410	
Compressor type		DC Inverter Scroll	DC Inverter Scroll	DC Inverter Scroll	DC Inverter Scroll
Quantity and type of the compressor	No.	4INV	4INV	6INV	6INV
Refrigerant type		R410A	R410A	R410A	R410A
Pre-charged refrigerant qty.	Kg	20	20	30	30
Ø Liquid side refrigerant pipe	mm (inch)	19.05 (3/4)	19.05 (3/4)	19.05 (3/4)	19.05 (3/4)
Ø Gas side refrigerant pipe	mm (inch)	38.10 (1-1/2)	38.10 (1-1/2)	38.10 (1-1/2)	38.10 (1-1/2)
Maximum piping length	m	1000	1000	1000	1000
Max linear piping length (Equivalent/Real)	m	260/220	260/220	260/220	260/220
Standard height difference between IU and OU	m	110/90	110/90	110/90	110/90
Standard height difference between IU and IU	m	50/40	50/40	50/40	50/40
Max. drop between IU *3	m	30	30	30	30
Std. drop between IU *4	m	18	18	18	18
Static Pressure Fans	Pa	110	110	110	110
Connectable Indoor Capacity Ratio					
Indoor / Outdoor Capacity Ratio	%	50-130	50-130	50-130	50-130
Maximum number of connectable IUs	No.	64	64	64	64
External Temperature Operating Limits					
Cooling	°C	-5-52	-5-52	-5-52	-5-52
Heating	°C	-27-21	-27-21	-27-21	-27-21



58-64HP

AV18NMVETA

AV20NMVETA

AV22NMVETA

Model		AV58NMVETA AV18NMVETA AV20NMVETA AV20NMVETA	AV60NMVETA AV20NMVETA AV20NMVETA AV20NMVETA	AV62NMVETA AV20NMVETA AV20NMVETA AV22NMVETA	AV64NMVETA AV20NMVETA AV22NMVETA AV22NMVETA
Capacity					
Power Class	HP	58	60	62	64
Cooling	kW	162,40	168,00	173,50	179,00
Heating	kW	162,40	168,00	173,50	179,00
Electrical Parameters					
Power supply	Ph/V/Hz	"3/380-400/50/60 (5 wires L1+L2+L3+N+T)"	"3/380-400/50/60 (5 wires L1+L2+L3+N+T)"	"3/380-400/50/60 (5 wires L1+L2+L3+N+T)"	"3/380-400/50/60 (5 wires L1+L2+L3+N+T)"
Absorbed power - Cooling	kW	48,84	49,85	53,40	56,95
Max absorbed power - Cooling	kW	83,72	86,73	89,64	92,55
Absorbed current in cooling	A	82,45	84,16	90,15	96,14
Max absorbed current - Cooling	A	132,90	138,90	144,51	150,12
Absorbed power - Heating	kW	42,51	43,98	47,96	51,93
Max absorbed power - Heating	kW	71,33	74,10	75,09	76,08
Absorbed current in heating	A	71,77	74,25	80,96	87,67
Max absorbed current - Heating	A	118,76	123,38	125,03	126,68
EER energy class	W/W	3,33	3,37	3,25	3,14
COP energy class	W/W	3,82	3,82	3,62	3,45
SEER energy class	W/W	6,75	6,75	6,54	6,54
SCOP energy class	W/W	4,15	4,20	4,20	4,20
ηs,c %		267	267	259	259
ηs,h %		163	165	165	165
Ventilation					
Air flow (High)	m³/h	51000	51000	52000	53000
Sound pressure level (High)	dB(A)	65,8	65,8	65,8	65,8
Sound power level (High)	dB(A)	93	93	93,5	94
Installation - Dimensions - Components					
Unit Dimensions WxDxH	mm	1410x750x1690+1410x750x1690+1410x750x1690			
Packaged unit dimensions WxDxH	mm	1485x850x1858+1485x850x1858+1485x850x1858			
Net weight / Gross weight	Kg	385/410+385/410+385/410			
Compressor type		DC Inverter Scroll	DC Inverter Scroll	DC Inverter Scroll	DC Inverter Scroll
Quantity and type of the compressor	No.	6INV	6INV	6INV	6INV
Refrigerant type		R410A	R410A	R410A	R410A
Pre-charged refrigerant qty.	Kg	30	30	30	30
Ø Liquid side refrigerant pipe	mm (inch)	19,05 (3/4)	19,05 (3/4)	19,05 (3/4)	19,05 (3/4)
Ø Gas side refrigerant pipe	mm (inch)	41,30 (1-5/8)	41,30 (1-5/8)	41,30 (1-5/8)	41,30 (1-5/8)
Maximum piping length	m	1000	1000	1000	1000
Max linear piping length (Equivalent/Real)	m	260/220	260/220	260/220	260/220
Max. drop between IU and OU (O.U. down/up)*1	m	110/90	110/90	110/90	110/90
Std. drop between IU and OU (O.U. up/down)*2	m	50/40	50/40	50/40	50/40
Max. drop between IU *3	m	30	30	30	30
Std. drop between IU *4		18	18	18	18
Static Pressure Fans	Pa	110	110	110	110
Connectable Indoor Capacity Ratio					
Indoor / Outdoor Capacity Ratio	%	50-130	50-130	50-130	50-130
Maximum number of connectable IUs	No.	64	64	64	64
External Temperature Operating Limits					
Cooling	°C	-5-52	-5-52	-5-52	-5-52
Heating	°C	-27-21	-27-21	-27-21	-27-21

Outdoor Units

MRV5-H DC INVERTER

Haier



66-72HP

AV22NMVETA

AV24NMVETA

Model		AV66NMVETA AV22NMVETA AV22NMVETA AV22NMVETA	AV68NMVETA AV22NMVETA AV22NMVETA AV24NMVETA	AV70NMVETA AV22NMVETA AV24NMVETA AV24NMVETA	AV72NMVETA AV24NMVETA AV24NMVETA AV24NMVETA
Capacity					
Power Class	HP	66	68	70	72
Cooling	kW	184,50	191,00	197,50	204,00
Heating	kW	184,50	191,00	197,50	204,00
Electrical Parameters					
Power supply	Ph/V/Hz	"3/380-400/50/60 (5 wires L1+L2+L3+N+T)"	"3/380-400/50/60 (5 wires L1+L2+L3+N+T)"	"3/380-400/50/60 (5 wires L1+L2+L3+N+T)"	"3/380-400/50/60 (5 wires L1+L2+L3+N+T)"
Absorbed power - Cooling	kW	60,49	62,99	65,50	68,00
Max absorbed power - Cooling	kW	95,46	96,45	97,44	98,43
Absorbed current in cooling	A	102,12	106,35	110,57	114,80
Max absorbed current - Cooling	A	155,73	157,94	160,15	162,36
Absorbed power - Heating	kW	55,91	56,70	57,49	58,29
Max absorbed power - Heating	kW	77,08	81,78	86,49	91,20
Absorbed current in heating	A	94,39	95,72	97,06	98,40
Max absorbed current - Heating	A	128,33	136,17	144,01	151,85
EER energy class	W/W	3,05	3,03	3,02	3,00
COP energy class	W/W	3,30	3,37	3,44	3,50
SEER energy class	W/W	6,54	5,83	5,83	5,83
SCOP energy class	W/W	4,21	4,17	4,17	4,17
ηs,c %		259	230	230	230
ηs,h %		165	164	164	164
Ventilation					
Air flow (High)	m ³ /h	54000	54000	54000	54000
Sound pressure level (High)	dB(A)	65,8	66	66,5	66,8
Sound power level (High)	dB(A)	95	95	95	95
Installation - Dimensions - Components					
Unit Dimensions WxDxH	mm	1410x750x1690+1410x750x1690+1410x750x1690			
Packaged unit dimensions WxDxH	mm	1485x850x1858+1485x850x1858+1485x850x1858			
Net weight / Gross weight	Kg	385/410+385/410+385/410			
Compressor type		DC Inverter Scroll	DC Inverter Scroll	DC Inverter Scroll	DC Inverter Scroll
Quantity and type of the compressor	No.	6INV	6INV	6INV	6INV
Refrigerant type		R410A	R410A	R410A	R410A
Pre-charged refrigerant qty.	Kg	30	30	30	30
Ø Liquid side refrigerant pipe	mm	19,05 (3/4)	22,20 (7/8)	22,20 (7/8)	22,20 (7/8)
Ø Gas side refrigerant pipe	mm	41,30 (1-5/8)	44,50 (1-3/4)	44,50 (1-3/4)	44,50 (1-3/4)
Maximum piping length	m	1000	1000	1000	1000
Max linear piping length (Equivalent/Real)	m	260/220	260/220	260/220	260/220
Max. drop between IU and OU (O.U. down/up)*1	m	110/90	110/90	110/90	110/90
Std. drop between IU and OU (O.U. up/down)*2		50/40	50/40	50/40	50/40
Max. drop between IU *3	m	30	30	30	30
Std. drop between IU *4		18	18	18	18
Static Pressure Fans	Pa	110	110	110	110
Connectable Indoor Capacity Ratio					
Indoor / Outdoor Capacity Ratio	%	50-130	50-130	50-130	50-130
Maximum number of connectable IUs	No.	64	64	64	64
External Temperature Operating Limits					
Cooling	°C	-5-52	-5-52	-5-52	-5-52
Heating	°C	-27-21	-27-21	-27-21	-27-21



74-78HP

AV24NMVETA

AV26NMVETA

Model		AV74NMVETA AV24NMVETA AV24NMVETA AV26NMVETA	AV76NMVETA AV24NMVETA AV26NMVETA AV26NMVETA	AV78NMVETA AV26NMVETA AV26NMVETA AV26NMVETA
Capacity				
Power Class	HP	74	76	78
Cooling	kW	209,50	215,00	220,50
Heating	kW	209,50	215,00	220,50
Electrical Parameters				
Power supply	Ph/V/Hz	"3/380-400/50/60 (5 wires L1+L2+L3+N+T)"	"3/380-400/50/60 (5 wires L1+L2+L3+N+T)"	"3/380-400/50/60 (5 wires L1+L2+L3+N+T)"
Absorbed power - Cooling	kW	72,56	77,11	81,67
Max absorbed power - Cooling	kW	103,42	108,41	113,40
Absorbed current in cooling	A	122,49	130,18	137,87
Max absorbed current - Cooling	A	170,15	177,94	185,73
Absorbed power - Heating	kW	61,83	65,37	68,91
Max absorbed power - Heating	kW	93,25	95,30	97,35
Absorbed current in heating	A	104,37	110,35	116,33
Max absorbed current - Heating	A	155,26	158,67	162,09
EER energy class	W/W	2,89	2,79	2,70
COP energy class	W/W	3,39	3,29	3,20
SEER energy class	W/W	5,15	5,15	5,15
SCOP energy class	W/W	3,50	3,50	3,50
η _{s,c} %		193	193	193
η _{s,h} %		137	137	137
Ventilation				
Air flow (High)	m ³ /h	55000	56000	57000
Sound pressure level (High)	dB(A)	66,8	66,8	66,8
Sound power level (High)	dB(A)	95	95	95
Installation - Dimensions - Components				
Unit Dimensions WxDxH	mm	1410x750x1690+1410x750x1690+1410x750x1690		
Packaged unit dimensions WxDxH	mm	1485x850x1858+1485x850x1858+1485x850x1858		
Net weight / Gross weight	Kg	385/410+385/410+385/410		
Compressor type		DC Inverter Scroll	DC Inverter Scroll	DC Inverter Scroll
Quantity and type of the compressor	No.	6INV	6INV	6INV
Refrigerant type		R410A	R410A	R410A
Pre-charged refrigerant qty.	Kg	30	30	30
Ø Liquid side refrigerant pipe	mm	22,20 (7/8)	22,20 (7/8)	22,20 (7/8)
Ø Gas side refrigerant pipe	mm	44,50 (1-3/4)	44,50 (1-3/4)	44,50 (1-3/4)
Maximum piping length	m	1000	1000	1000
Max linear piping length (Equivalent/Real)	m	260/220	260/220	260/220
Max. drop between IU and OU (O.U. down/up)*1	m	110/90	110/90	110/90
Std. drop between IU and OU (O.U. up/down)*2		50/40	50/40	50/40
Max. drop between IU *3	m	30	30	30
Std. drop between IU *4		18	18	18
Static Pressure Fans	Pa	110	110	110
Connectable Indoor Capacity Ratio				
Indoor / Outdoor Capacity Ratio	%	50-130	50-130	50-130
Maximum number of connectable IUs	No.	64	64	64
External Temperature Operating Limits				
Cooling	°C	-5-52	-5-52	-5-52
Heating	°C	-27-21	-27-21	-27-21

Outdoor Units

MRV5-H DC INVERTER

Haier



80-86HP

AV20NMVETA

AV22NMVETA

Model		AV80NMVETA AV20NMVETA AV20NMVETA AV20NMVETA AV20NMVETA	AV82NMVETA AV20NMVETA AV20NMVETA AV20NMVETA AV22NMVETA	AV84NMVETA AV20NMVETA AV20NMVETA AV22NMVETA AV22NMVETA	AV86NMVETA AV20NMVETA AV22NMVETA AV22NMVETA AV22NMVETA
Capacity					
Power Class	HP	80	82	84	86
Cooling	kW	224,00	229,50	235,00	240,50
Heating	kW	224,00	229,50	235,00	240,50
Electrical Parameters					
Power supply	Ph/V/Hz	"3/380-400/50/60 (5 wires L1+L2+L3+N+T)"	"3/380-400/50/60 (5 wires L1+L2+L3+N+T)"	"3/380-400/50/60 (5 wires L1+L2+L3+N+T)"	"3/380-400/50/60 (5 wires L1+L2+L3+N+T)"
Absorbed power - Cooling	kW	66,47	70,02	73,56	77,11
Max absorbed power - Cooling	kW	115,64	118,55	121,46	124,37
Absorbed current in cooling	A	112,21	118,20	124,19	130,18
Max absorbed current - Cooling	A	185,20	190,81	196,42	202,03
Absorbed power - Heating	kW	58,64	62,62	66,59	70,57
Max absorbed power - Heating	kW	98,80	99,79	100,78	101,78
Absorbed current in heating	A	98,99	105,71	112,42	119,13
Max absorbed current - Heating	A	164,50	166,15	167,81	169,46
EER energy class	W/W	3,37	3,28	3,19	3,12
COP energy class	W/W	3,82	3,67	3,53	3,41
SEER energy class	W/W	6,75	6,54	6,54	6,54
SCOP energy class	W/W	4,20	4,20	4,20	4,20
η _{s,c} %		267	259	259	259
η _{s,h} %		165	165	165	165
Ventilation					
Air flow (High)	m ³ /h	68000	69000	70000	71000
Sound pressure level (High)	dB(A)	67	67	67	67
Sound power level (High)	dB(A)	94	95	95	96
Installation - Dimensions - Components					
Unit Dimensions WxDxH	mm	1410x750x1690+1410x750x1690+1410x750x1690+1410x750x1690			
Packaged unit dimensions WxDxH	mm	1485x850x1858+1485x850x1858+1485x850x1858+1485x850x1858			
Net weight / Gross weight	Kg	385/410+385/410+385/410+385/410			
Compressor type		DC Inverter Scroll	DC Inverter Scroll	DC Inverter Scroll	DC Inverter Scroll
Quantity and type of the compressor	No.	8INV	8INV	8INV	8INV
Refrigerant type		R410A	R410A	R410A	R410A
Pre-charged refrigerant qty.	Kg	40	40	40	40
Ø Liquid side refrigerant pipe	mm	22,20 (7/8)	22,20 (7/8)	22,20 (7/8)	25,40 (1)
Ø Gas side refrigerant pipe	mm	44,50 (1-3/4)	44,50 (1-3/4)	44,50 (1-3/4)	50,80 (2)
Maximum piping length	m	1000	1000	1000	1000
Max linear piping length (Equivalent/Real)	m	260/220	260/220	260/220	260/220
Max. drop between IU and OU (O.U. down/up)*1	m	110/90	110/90	110/90	110/90
Std. drop between IU and OU (O.U. up/down)*2		50/40	50/40	50/40	50/40
Max. drop between IU *3	m	30	30	30	30
Std. drop between IU *4		18	18	18	18
Static Pressure Fans	Pa	110	110	110	110
Connectable Indoor Capacity Ratio					
Indoor / Outdoor Capacity Ratio	%	50-130	50-130	50-130	50-130
Maximum number of connectable IUs	No.	64	64	64	64
External Temperature Operating Limits					
Cooling	°C	-5-52	-5-52	-5-52	-5-52
Heating	°C	-27-21	-27-21	-27-21	-27-21



88-96HP

AV22NMVETA

AV24NMVETA

Model		AV88NMVETA AV22NMVETA AV22NMVETA AV22NMVETA AV22NMVETA	AV90NMVETA AV22NMVETA AV22NMVETA AV22NMVETA AV24NMVETA	AV92NMVETA AV22NMVETA AV22NMVETA AV24NMVETA AV24NMVETA	AV94NMVETA AV22NMVETA AV24NMVETA AV24NMVETA AV24NMVETA	AV96NMVETA AV24NMVETA AV24NMVETA AV24NMVETA AV24NMVETA
Capacity						
Power Class	HP	88	90	92	94	96
Cooling	kW	246,00	252,50	259,00	265,50	272,00
Heating	kW	246,00	252,50	259,00	265,50	272,00
Electrical Parameters						
Power supply	Ph/V/Hz	"3/380-400/50/60 (5 wires L1+L2+L3+N+T)"	"3/380-400/50/60 (5 wires L1+L2+L3+N+T)"	"3/380-400/50/60 (5 wires L1+L2+L3+N+T)"	"3/380-400/50/60 (5 wires L1+L2+L3+N+T)"	"3/380-400/50/60 (5 wires L1+L2+L3+N+T)"
Absorbed power - Cooling	kW	80,66	83,16	85,66	88,16	90,67
Max absorbed power - Cooling	kW	127,28	128,27	129,26	130,25	131,24
Absorbed current in cooling	A	136,16	140,39	144,61	148,84	153,06
Max absorbed current - Cooling	A	207,64	209,85	212,06	214,27	216,48
Absorbed power - Heating	kW	74,55	75,34	76,13	76,92	77,71
Max absorbed power - Heating	kW	102,77	107,48	112,18	116,89	121,60
Absorbed current in heating	A	125,85	127,19	128,52	129,86	131,20
Max absorbed current - Heating	A	171,11	178,95	186,79	194,63	202,46
EER energy class	W/W	3,05	3,04	3,02	3,01	3,00
COP energy class	W/W	3,30	3,35	3,40	3,45	3,50
SEER energy class	W/W	6,54	5,83	5,83	5,83	5,83
SCOP energy class	W/W	4,21	4,17	4,17	4,17	4,17
ηs,c %		259	230	230	230	230
ηs,h %		165	164	164	164	164
Ventilation						
Air flow (High)	m ³ /h	72000	72000	72000	72000	72000
Sound pressure level (High)	dB(A)	67	67,5	67,5	68	68
Sound power level (High)	dB(A)	96	96	96	96	96
Installation - Dimensions - Components						
Unit Dimensions WxDxH	mm	1410x750x1690+1410x750x1690+1410x750x1690+1410x750x1690				
Packaged unit dimensions WxDxH	mm	1485x850x1858+1485x850x1858+1485x850x1858+1485x850x1858				
Net weight / Gross weight	Kg	385/410+385/410+385/410+385/410				
Compressor type		DC Inverter Scroll	DC Inverter Scroll	DC Inverter Scroll	DC Inverter Scroll	DC Inverter Scroll
Quantity and type of the compressor	No.	8INV	8INV	8INV	8INV	8INV
Refrigerant type		R410A	R410A	R410A	R410A	R410A
Pre-charged refrigerant qty.	Kg	40	40	40	40	40
Ø Liquid side refrigerant pipe	mm (inch)	25,40 (1)	25,40 (1)	25,40 (1)	25,40 (1)	25,40 (1)
Ø Gas side refrigerant pipe	mm (inch)	50,80 (2)	50,80 (2)	50,80 (2)	50,80 (2)	50,80 (2)
Maximum piping length	m	1000	1000	1000	1000	1000
Max linear piping length (Equivalent/Real)	m	260/220	260/220	260/220	260/220	260/220
Max. drop between IU and OU (O.U. down/up)*1	m	110/90	110/90	110/90	110/90	110/90
Std. drop between IU and OU (O.U. up/down)*2		50/40	50/40	50/40	50/40	50/40
Max. drop between IU *3	m	30	30	30	30	30
Std. drop between IU *4		18	18	18	18	18
Static Pressure Fans	Pa	110	110	110	110	110
Connectable Indoor Capacity Ratio						
Indoor / Outdoor Capacity Ratio	%	50-130	50-130	50-130	50-130	50-130
Maximum number of connectable IUs	No.	64	64	64	64	64
External Temperature Operating Limits						
Cooling	°C	-5-52	-5-52	-5-52	-5-52	-5-52
Heating	°C	-27-21	-27-21	-27-21	-27-21	-27-21

Outdoor Units

MRV5-H

DC INVERTER

Haier



98-104HP

AV24NMVETA

AV26NMVETA

Model		AV98NMVETA AV24NMVETA AV24NMVETA AV24NMVETA AV26NMVETA	AV100NMVETA AV24NMVETA AV24NMVETA AV26NMVETA AV26NMVETA	AV102NMVETA AV24NMVETA AV26NMVETA AV26NMVETA AV26NMVETA	AV104NMVETA AV26NMVETA AV26NMVETA AV26NMVETA AV26NMVETA
Capacity					
Power Class	HP	98	100	102	104
Cooling	kW	277,50	283,00	288,50	294,00
Heating	kW	277,50	283,00	288,50	294,00
Electrical Parameters					
Power supply	Ph/V/Hz	"3/380-400/50/60 (5 wires L1+L2+L3+N+T)"	"3/380-400/50/60 (5 wires L1+L2+L3+N+T)"	"3/380-400/50/60 (5 wires L1+L2+L3+N+T)"	"3/380-400/50/60 (5 wires L1+L2+L3+N+T)"
Absorbed power - Cooling	kW	95,22	99,78	104,33	108,89
Max absorbed power - Cooling	kW	136,23	141,22	146,21	151,20
Absorbed current in cooling	A	160,75	168,45	176,14	183,83
Max absorbed current - Cooling	A	224,27	232,06	239,85	247,64
Absorbed power - Heating	kW	81,25	84,79	88,33	91,88
Max absorbed power - Heating	kW	123,65	125,70	127,75	129,80
Absorbed current in heating	A	137,17	143,15	149,13	155,10
Max absorbed current - Heating	A	205,88	209,29	212,70	216,12
EER energy class	W/W	2,91	2,84	2,77	2,70
COP energy class	W/W	3,42	3,34	3,27	3,20
SEER energy class	W/W	5,15	5,15	5,15	5,15
SCOP energy class	W/W	3,50	3,50	3,50	3,50
η _{s,c} %		193	193	193	193
η _{s,h} %		137	137	137	137
Ventilation					
Air flow (High)	m ³ /h	73000	74000	75000	76000
Sound pressure level (High)	dB(A)	68	68	68	68
Sound power level (High)	dB(A)	96	96	96	96
Installation - Dimensions - Components					
Unit Dimensions WxDxH	mm	1410x750x1690+1410x750x1690+1410x750x1690+1410x750x1690			
Packaged unit dimensions WxDxH	mm	1485x850x1858+1485x850x1858+1485x850x1858+1485x850x1858			
Net weight / Gross weight	Kg	385/410+385/410+385/410+385/410			
Compressor type		DC Inverter Scroll	DC Inverter Scroll	DC Inverter Scroll	DC Inverter Scroll
Quantity and type of the compressor	No.	8INV	8INV	8INV	8INV
Refrigerant type		R410A	R410A	R410A	R410A
Pre-charged refrigerant qty.	Kg	40	40	40	40
Ø Liquid side refrigerant pipe	mm	25,40 (1)	25,40 (1)	25,40 (1)	25,40 (1)
Ø Gas side refrigerant pipe	mm	54,10 (2-1/8)	54,10 (2-1/8)	54,10 (2-1/8)	54,10 (2-1/8)
Maximum piping length	m	1000	1000	1000	1000
Max linear piping length (Equivalent/Real)	m	260/220	260/220	260/220	260/220
Max. drop between IU and OU (O.U. down/up)*1	m	110/90	110/90	110/90	110/90
Std. drop between IU and OU (O.U. up/down)*2		50/40	50/40	50/40	50/40
Max. drop between IU *3	m	30	30	30	30
Std. drop between IU *4		18	18	18	18
Static Pressure Fans	Pa	110	110	110	110
Connectable Indoor Capacity Ratio					
Indoor / Outdoor Capacity Ratio	%	50-130	50-130	50-130	50-130
Maximum number of connectable IUs	No.	64	64	64	64
External Temperature Operating Limits					
Cooling	°C	-5-52	-5-52	-5-52	-5-52
Heating	°C	-27-21	-27-21	-27-21	-27-21



MRV5-RC

DC INVERTER

Full DC Inverter
3-Pipe Heat
Recovery Systems

MRV5-RC DC INVERTER

Simultaneous heating and cooling available with a 3-pipe heat recovery outdoor unit

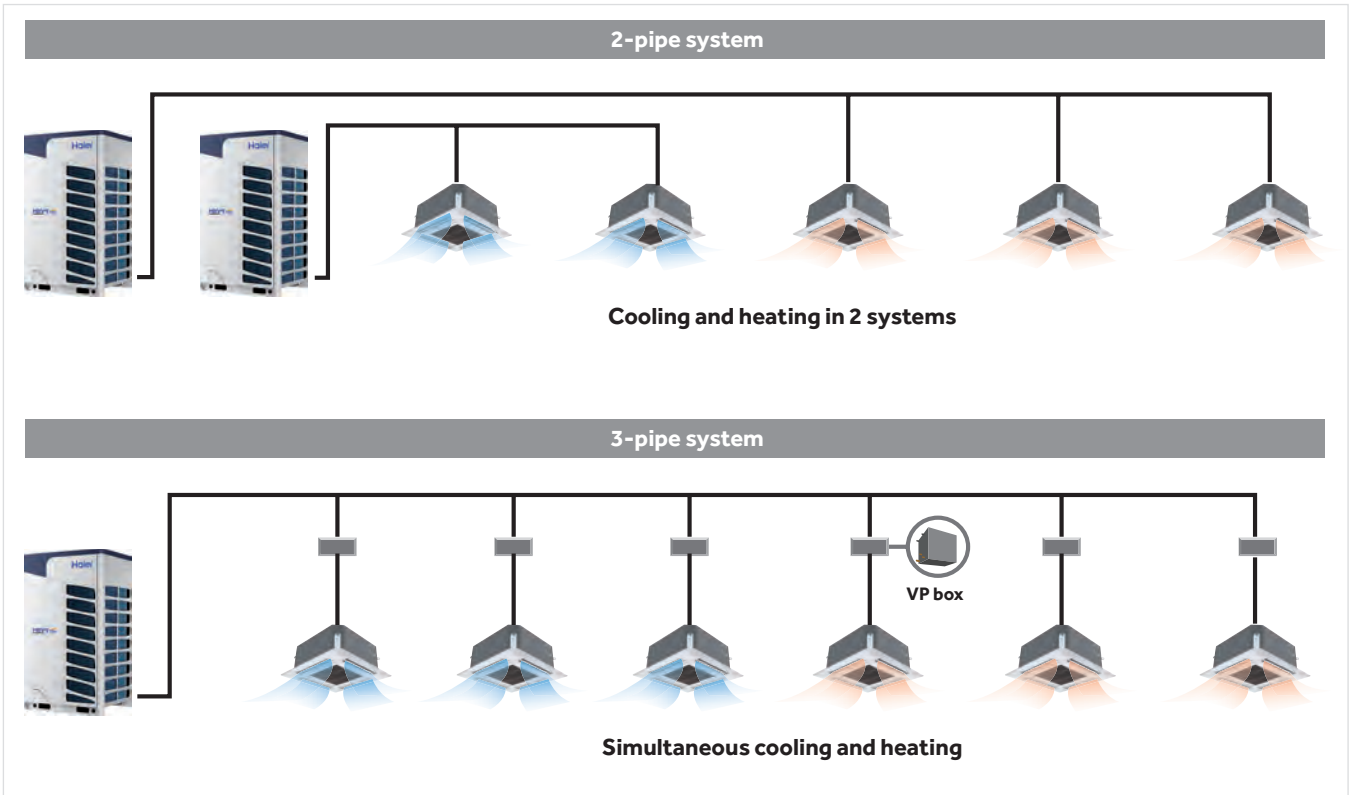

Various modes of simultaneous operation

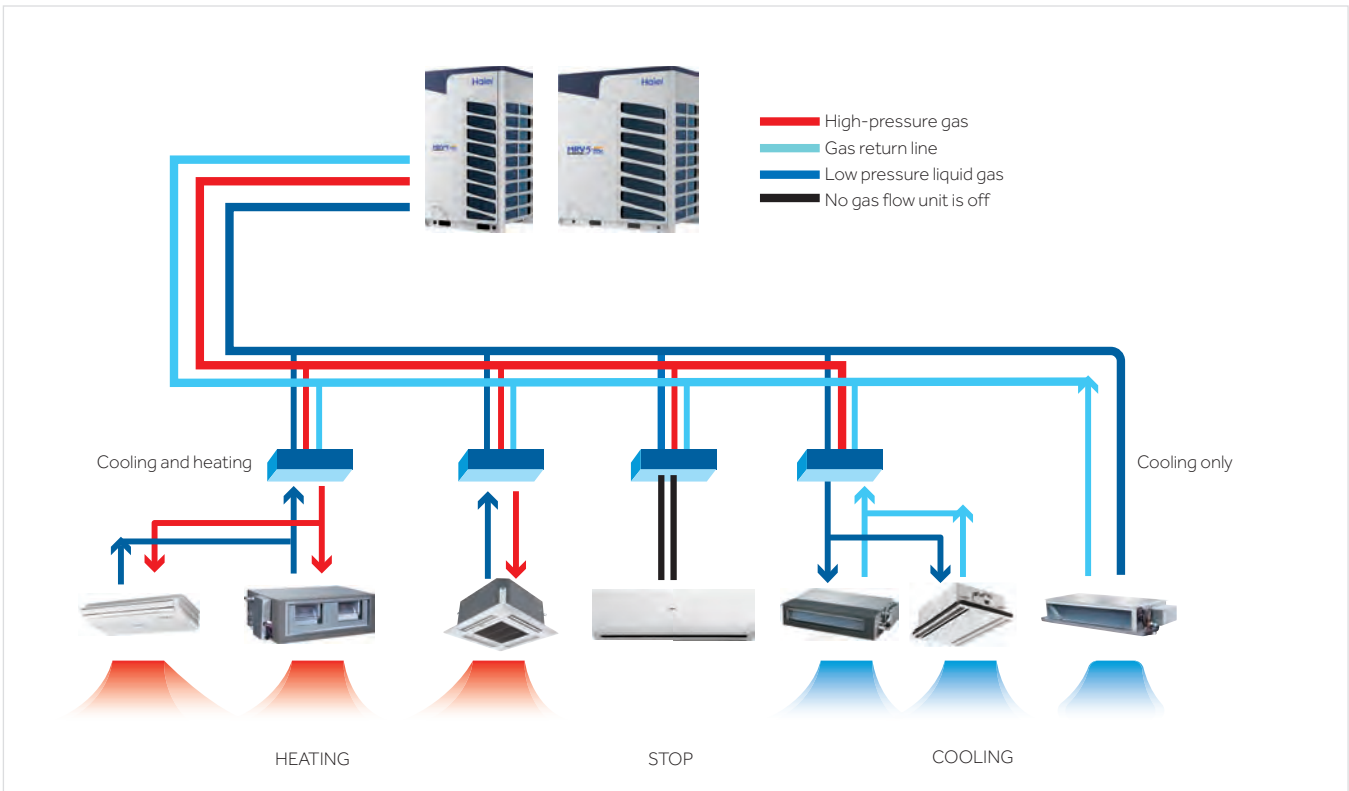

MRV5-RC

DC INVERTER

EXAMPLE OF A 3-PIPE MRV 5-RC SYSTEM

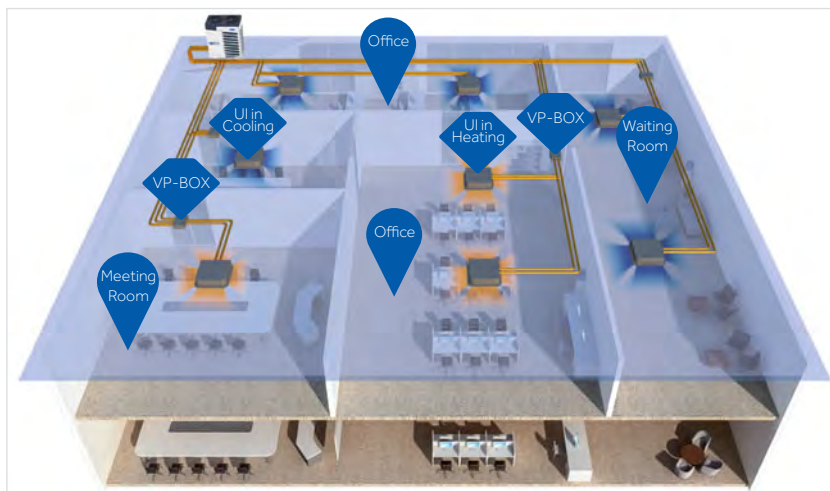

NEW SELECTION VALVES

- Reduced clutter
- Electronic valves for each flow line

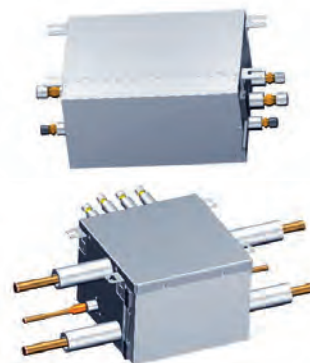

NEW SELECTION VALVES

- Specially designed for MRV 5-RC, volume is small to 0,02m³ (for VP1 box), 0,05m³ (for VP4 box).
- Extensively reduces installation space.
- Individual Valve and Pipe Box for Heat Recovery.
- The valve box can be connected in a series which reduces the use of diverging pipes and reduces the installation cost.

Model*	Maximum connectable capacity (kW)	Power supply	Maximum number of connectable indoor units, same mode of operation	Dimensions (mm)
VP1-112C	$x \leq 11,2$	220-240V single-phase - 50/60Hz	5	388x200x277
VP1-180C	$11,2 < x \leq 18,0$	220-240V single-phase - 50/60Hz	8	388x200x277
VP1-280C	$18,0 < x \leq 28,0$	220-240V single-phase - 50/60Hz	8	388x200x277
VP4-450C	4 ways - max 11,2kW for single output.	220-240V single-phase - 50/60Hz	20	405x300x421

The 4-way box has standard closed output connections. To be opened in case of multiple installations, so that the output of the box becomes the input of the next box. You can connect multiple 4-way boxes in sequence. The input power limit of a series is a maximum of 71 kW.

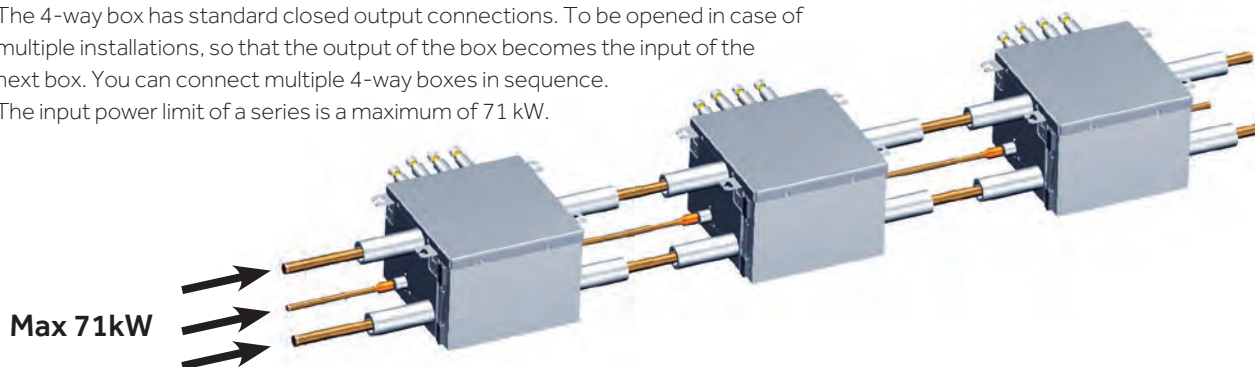

FLEXIBLE INSTALLATION - ability to reverse the orientation of the series in order to have the connections of the indoor units on the right or left or alternating with respect to the main line.

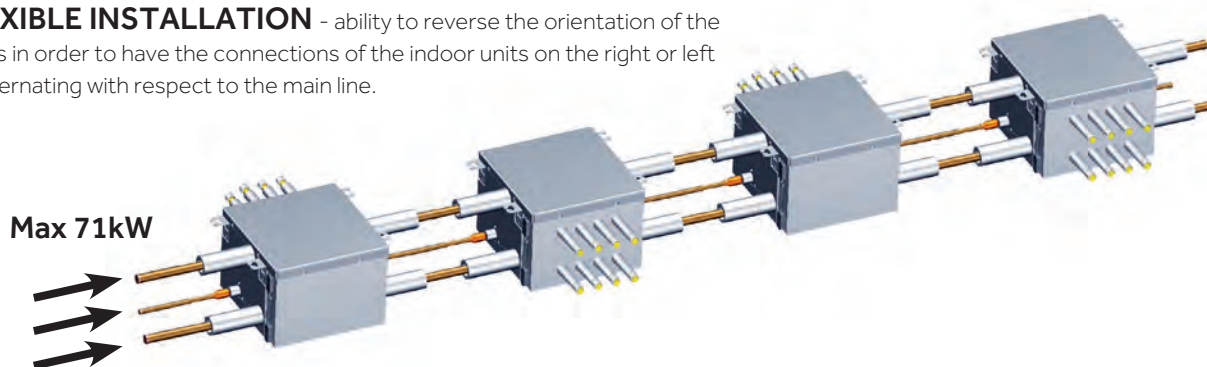

* (limit determined by the diameters of the input pipes of the valve boxes)



8-14HP

AV08IMVURA
AV10IMVURA
AV12IMVURA
AV14IMVURA

Model		AV08IMVURA	AV10IMVURA	AV12IMVURA	AV14IMVURA
Capacity					
Power Class	HP	8	10	12	14
Cooling	kW	22,40	28,00	33,50	40,00
Heating	kW	22,40	28,00	33,50	40,00
Electrical Parameters					
Power supply	Ph/V/Hz	3/380-400/50/60 (5 wires L1+L2+L3+N+T)	3/380-400/50/60 (5 wires L1+L2+L3+N+T)	3/380-400/50/60 (5 wires L1+L2+L3+N+T)	3/380-400/50/60 (5 wires L1+L2+L3+N+T)
Absorbed power - Cooling	kW	5,83	7,67	9,94	12,31
Max absorbed power - Cooling	kW	12,80	13,80	18,20	19,20
Absorbed current in cooling.	A	9,63	12,67	16,43	20,33
Max absorbed current - Cooling	A	21,14	22,79	30,06	31,71
Absorbed power – Heating	kW	5,38	6,67	8,77	10,53
Max absorbed power – Heating	kW	11,50	12,50	17,40	18,40
Absorbed current in heating	A	8,88	11,01	14,48	17,38
Max absorbed current – Heating	A	18,99	20,64	28,74	30,39
EER energy class	W/W	3,84	3,65	3,37	3,25
COP energy class	W/W	4,16	4,20	3,82	3,80
SEER energy class	W/W	6,12	6,68	6,46	6,37
SCOP energy class	W/W	3,82	3,94	3,99	3,77
ηs,c %		242	264	255	252
ηs,h %		150	155	157	148
Ventilation					
Air flow (High)	m³/h	12000	12000	13500	13500
Sound pressure level (High)	dB(A)	57	58	60	61
Sound power level (High)	dB(A)	81	82	88	88
Installation - Dimensions - Components					
Unit Dimensions WxDxH	mm	980x750x1690			
Packaged unit dimensions WxDxH	mm	1070x850x1858			
Net weight / Gross weight	Kg	246/271		257/282	
Compressor type		DC Inverter Scroll	DC Inverter Scroll	DC Inverter Scroll	DC Inverter Scroll
Quantity and type of the compressor	No.	1 INV	1 INV	1 INV	1 INV
Refrigerant type		R410A	R410A	R410A	R410A
Pre-charged refrigerant qty.	Kg	10	10	10	10
Ø Liquid side refrigerant pipe	mm (inch)	9,52 (3/8)	9,52 (3/8)	12,70 (1/2)	12,70 (1/2)
Ø Gas recovery side refrigerant pipe	mm (inch)	19,05 (3/4)	22,22 (7/8)	25,40 (1)	25,40 (1)
Ø High-pressure refrigerant gas pipe	mm (inch)	19,05 (3/4)	19,05 (3/4)	22,22 (7/8)	22,22 (7/8)
Maximum piping length	m	1000	1000	1000	1000
Max linear piping length (Equivalent/Real)	m	260/220	260/220	260/220	260/220
Max. drop between IU and OU (O.U. down/up)*1	m	110/90	110/90	110/90	110/90
Std. drop between IU and OU (O.U. up/down)*2		50/40	50/40	50/40	50/40
Max. drop between IU *3	m	30	30	30	30
Std. drop between IU *4		18	18	18	18
Static Pressure Fans	Pa	110	110	110	110
Connectable Indoor Capacity Ratio					
Indoor / Outdoor Capacity Ratio	%	50 – 130	50 – 130	50 – 130	50 – 130
Maximum number of connectable IUs	No.	13	16	20	24
External Temperature Operating Limits					
Cooling	°C	-5-50	-5-50	-5-50	-5-50
Heating	°C	-23-21	-23-21	-23-21	-23-21

The specifications indicated are obtained with the following test conditions: in Cooling mode, Indoor temperature of 27°C DB / 19°C WB and Outdoor temperature of 35°C DB / 24°C WB. In Heating mode, Indoor temperature of 20°C WB and Outdoor temperature of 7°C DB / 6°C WB

Outdoor Units

MRV5-RC

DC INVERTER



16-22HP

AV16IMVURA
AV18IMVURA
AV20IMVURA
AV22IMVURA

Model		AV16IMVURA	AV18IMVURA	AV20IMVURA	AV22IMVURA
Capacity					
Power Class	HP	16	18	20	22
Cooling	kW	45,00	50,00	56,00	60,00
Heating	kW	45,00	50,00	56,00	60,00
Electrical Parameters					
Power supply	Ph/V/Hz	3/380-400/50/60 (5 wires L1+L2+L3+N+T)	3/380-400/50/60 (5 wires L1+L2+L3+N+T)	3/380-400/50/60 (5 wires L1+L2+L3+N+T)	3/380-400/50/60 (5 wires L1+L2+L3+N+T)
Absorbed power - Cooling	kW	13,93	16,13	20,29	22,22
Max absorbed power - Cooling	kW	25,10	28,50	32,00	33,00
Absorbed current in cooling.	A	23,01	26,64	28,46	33,03
Max absorbed current - Cooling	A	41,45	47,07	52,85	54,50
Absorbed power – Heating	kW	11,39	13,70	15,77	17,91
Max absorbed power – Heating	kW	22,70	25,50	29,40	30,40
Absorbed current in heating	A	18,81	22,62	26,05	29,58
Max absorbed current – Heating	A	37,49	42,11	48,55	50,21
EER energy class	W/W	3,23	3,10	2,76	2,70
COP energy class	W/W	3,95	3,65	3,55	3,35
SEER energy class	W/W	6,86	6,48	5,78	5,63
SCOP energy class	W/W	4,21	3,99	3,93	3,50
ηs,c %		271	256	228	222
ηs,h %		165	157	154	137
Ventilation					
Air flow (High)	m ³ /h	17000	17000	19000	19000
Sound pressure level (High)	dB(A)	62	63	63	64
Sound power level (High)	dB(A)	88	88	88	90
Installation - Dimensions - Components					
Unit Dimensions WxDxH	mm	1410x750x1690			
Packaged unit dimensions WxDxH	mm	1485x850x1858			
Net weight / Gross weight	Kg	366/395		375/404	
Compressor type		DC Inverter Scroll	DC Inverter Scroll	DC Inverter Scroll	DC Inverter Scroll
Quantity and type of the compressor	No.	2 INV	2 INV	2 INV	2 INV
Refrigerant type		R410A	R410A	R410A	R410A
Pre-charged refrigerant qty.	Kg	10	10	10	10
Ø Liquid side refrigerant pipe	mm (inch)	12,70 (1/2)	15,88 (5/8)	15,88 (5/8)	15,88 (5/8)
Ø Gas recovery side refrigerant pipe	mm (inch)	28,58 (1-1/8)	28,58 (1-1/8)	28,58 (1-1/8)	28,58 (1-1/8)
Ø High-pressure refrigerant gas pipe	mm (inch)	25,40 (1)	25,40 (1)	25,40 (1)	25,40 (1)
Maximum piping length	m	1000	1000	1000	1000
Max linear piping length (Equivalent/Real)	m	260/220	260/220	260/220	260/220
Standard height difference between IU and OU	m	110/90	110/90	110/90	110/90
Std. drop between IU and OU (O.U. up/down)*2	m	50/40	50/40	50/40	50/40
Max. drop between IU *3	m	30	30	30	30
Std. drop between IU *4	m	18	18	18	18
Static Pressure Fans	Pa	110	110	110	110
Connectable Indoor Capacity Ratio					
Indoor / Outdoor Capacity Ratio	%	50 – 130	50 – 130	50 – 130	50 – 130
Maximum number of connectable IUs	No.	27	30	33	36
External Temperature Operating Limits					
Cooling	°C	-5-50	-5-50	-5-50	-5-50
Heating	°C	-23-21	-23-21	-23-21	-23-21

The specifications indicated are obtained with the following test conditions: in Cooling mode, Indoor temperature of 27°C DB / 19°C WB and Outdoor temperature of 35°C DB / 24°C WB. In Heating mode, Indoor temperature of 20°C WB and Outdoor temperature of 7°C DB / 6°C WB

The data in this catalogue is purely indicative as the data may vary.
Please be advised to check the accuracy of the data with the supplier before purchasing products.



24-30HP

AV12IMVURA

AV14IMVURA

AV16IMVURA

Model		AV24IMVURA AV12IMVURA AV12IMVURA	AV26IMVURA AV12IMVURA AV14IMVURA	AV28IMVURA AV14IMVURA AV14IMVURA	AV30IMVURA AV14IMVURA AV16IMVURA
Capacity					
Power Class	HP	24	26	28	30
Cooling	kW	67,00	73,50	80,00	85,00
Heating	kW	67,00	73,50	80,00	85,00
Electrical Parameters					
Power supply	Ph/V/Hz	3/380-400/50/60 (5 wires L1+L2+L3+N+T)		3/380-400/50/60 (5 wires L1+L2+L3+N+T)	
Absorbed power - Cooling	kW	19,88	22,25	24,62	26,24
Max absorbed power - Cooling	kW	36,40	37,40	38,40	44,30
Absorbed current in cooling.	A	32,83	36,74	40,65	43,33
Max absorbed current - Cooling	A	60,11	61,77	63,42	73,16
Absorbed power - Heating	kW	17,54	19,30	21,05	21,92
Max absorbed power - Heating	kW	34,80	35,80	36,80	41,10
Absorbed current in heating	A	28,97	31,87	34,77	36,20
Max absorbed current - Heating	A	57,47	59,12	60,78	67,88
EER energy class	W/W	3,37	3,30	3,25	3,24
COP energy class	W/W	3,82	3,81	3,80	3,88
SEER energy class	W/W	6,46	6,37	6,37	6,37
SCOP energy class	W/W	3,99	3,77	3,77	3,77
η _{s,c} %		255	252	252	252
η _{s,h} %		157	148	148	148
Ventilation					
Air flow (High)	m ³ /h	27000	27000	27000	30500
Sound pressure level (High)	dB(A)	63	64	64	65
Sound power level (High)	dB(A)	88	90	90	91
Installation - Dimensions - Components					
Unit Dimensions WxDxH	mm	980x750x1690+980x750x1690			980x750x1690 + 1410x750x1690
Packaged unit dimensions WxDxH	mm	1070x850x1858+1070x850x1858			1070x850x1858 + 1515x850x1858
Net weight / Gross weight	Kg	246/271+246/271			246/271+366/395
Compressor type		DC Inverter Scroll	DC Inverter Scroll	DC Inverter Scroll	DC Inverter Scroll
Quantity and type of the compressor	No.	2 INV	2 INV	2 INV	3 INV
Refrigerant type		R410A	R410A	R410A	R410A
Pre-charged refrigerant qty.	Kg	20	20	20	20
Ø Liquid side refrigerant pipe	mm (inch)	15,88 (5/8)	15,88 (5/8)	15,88 (5/8)	19,05 (3/4)
Ø Gas recovery side refrigerant pipe	mm (inch)	28,58 (1-1/8)	28,58 (1-1/8)	28,58 (1-1/8)	31,80 (1-1/4)
Ø High-pressure refrigerant gas pipe	mm (inch)	25,40 (1)	25,40 (1)	25,40 (1)	25,40 (1)
Maximum piping length	m	1000	1000	1000	1000
Max linear piping length (Equivalent/Real)	m	260/220	260/220	260/220	260/220
Max. drop between IU and OU (O.U. down/up)*1	m	110/90	110/90	110/90	110/90
Std. drop between IU and OU (O.U. up/down)*2	m	50/40	50/40	50/40	50/40
Max. drop between IU *3	m	30	30	30	30
Std. drop between IU *4	m	18	18	18	18
Static Pressure Fans	Pa	110	110	110	110
Connectable Indoor Capacity Ratio					
Indoor / Outdoor Capacity Ratio	%	50 – 130	50 – 130	50 – 130	50 – 130
Maximum number of connectable IUs	No.	40	43	47	50
External Temperature Operating Limits					
Cooling	°C	-5-50	-5-50	-5-50	-5-50
Heating	°C	-23-21	-23-21	-23-21	-23-21

The specifications indicated are obtained with the following test conditions: in Cooling mode, Indoor temperature of 27°C DB / 19°C WB and Outdoor temperature of 35°C DB / 24°C WB. In Heating mode, Indoor temperature of 20°C WB and Outdoor temperature of 7°C DB / 6°C WB

Outdoor Units

MRV5-RC

DC INVERTER



32-40HP

AV16IMVURA
AV18IMVURA
AV20IMVURA

Model		AV32IMVURA AV16IMVURA AV16IMVURA	AV34IMVURA AV16IMVURA AV18IMVURA	AV36IMVURA AV18IMVURA AV18IMVURA	AV38IMVURA AV18IMVURA AV20IMVURA	AV40IMVURA AV20IMVURA AV20IMVURA
Capacity						
Power Class	HP	32	34	36	38	40
Cooling	kW	90,00	95,00	100,00	106,00	112,00
Heating	kW	90,00	95,00	100,00	106,00	112,00
Electrical Parameters						
Power supply	Ph/V/Hz	3/380-400/50/60 (5 wires L1+L2+L3+N+T)	3/380-400/50/60 (5 wires L1+L2+L3+N+T)	3/380-400/50/60 (5 wires L1+L2+L3+N+T)	3/380-400/50/60 (5 wires L1+L2+L3+N+T)	3/380-400/50/60 (5 wires L1+L2+L3+N+T)
Absorbed power - Cooling	kW	27,86	30,06	32,26	36,42	40,58
Max absorbed power - Cooling	kW	50,20	53,60	57,00	60,50	64,00
Absorbed current in cooling.	A	46,02	49,65	53,27	55,09	56,91
Max absorbed current - Cooling	A	82,91	88,52	94,14	99,92	105,70
Absorbed power – Heating	kW	22,78	25,09	27,40	29,47	31,54
Max absorbed power – Heating	kW	45,40	48,20	51,00	54,90	58,80
Absorbed current in heating	A	37,63	41,44	45,25	48,67	52,09
Max absorbed current – Heating	A	74,98	79,60	84,23	90,67	97,11
EER energy class	W/W	3,23	3,16	3,10	2,91	2,76
COP energy class	W/W	3,95	3,79	3,65	3,60	3,55
SEER energy class	W/W	6,86	6,48	6,48	5,78	5,78
SCOP energy class	W/W	4,21	3,99	3,99	3,93	3,93
η _{s,c} %		271	256	256	228	228
η _{s,h} %		165	157	157	154	154
Ventilation						
Air flow (High)	m ³ /h	34000	34000	34000	36000	38000
Sound pressure level (High)	dB(A)	65	66	66	66	66
Sound power level (High)	dB(A)	91	92	92	92	92
Installation - Dimensions - Components						
Unit Dimensions WxDxH	mm	1410x750x1690+1410x750x1690				
Packaged unit dimensions WxDxH	mm	1515x850x1858+1515x850x1858				
Net weight / Gross weight	Kg	366/395 + 366/395			375/404 + 375/404	
Compressor type		DC Inverter Scroll	DC Inverter Scroll	DC Inverter Scroll	DC Inverter Scroll	DC Inverter Scroll
Quantity and type of the compressor	No.	4 INV	4 INV	4 INV	4 INV	4 INV
Refrigerant type		R410A	R410A	R410A	R410A	R410A
Pre-charged refrigerant qty.	Kg	20	20	20	20	20
Ø Liquid side refrigerant pipe	mm (inch)	19,05 (3/4)	19,05 (3/4)	19,05 (3/4)	19,05 (3/4)	19,05 (3/4)
Ø Gas recovery side refrigerant pipe	mm (inch)	31,80 (1-1/4)	31,80 (1-1/4)	38,10 (1-1/2)	38,10 (1-1/2)	38,10 (1-1/2)
Ø High-pressure refrigerant gas pipe	mm (inch)	28,58 (1-1/8)	28,58 (1-1/8)	34,9 (1-3/8)	34,9 (1-3/8)	34,9 (1-3/8)
Maximum piping length	m	1000	1000	1000	1000	1000
Max linear piping length (Equivalent/Real)	m	260/220	260/220	260/220	260/220	260/220
Max. drop between IU and OU (O.U. down/ up)*1	m	110/90	110/90	110/90	110/90	110/90
Std. drop between IU and OU (O.U. up/ down)*2	m	50/40	50/40	50/40	50/40	50/40
Max. drop between IU *3	m	30	30	30	30	30
Std. drop between IU *4	m	18	18	18	18	18
Static Pressure Fans	Pa	110	110	110	110	110
Connectable Indoor Capacity Ratio						
Indoor / Outdoor Capacity Ratio	%	50 – 130	50 – 130	50 – 130	50 – 130	50 – 130
Maximum number of connectable IUs	No.	53	56	59	63	64
External Temperature Operating Limits						
Cooling	°C	-5-50	-5-50	-5-50	-5-50	-5-50
Heating	°C	-23-21	-23-21	-23-21	-23-21	-23-21

The specifications indicated are obtained with the following test conditions: in Cooling mode, Indoor temperature of 27°C DB / 19°C WB and Outdoor temperature of 35°C DB / 24°C WB. In Heating mode, Indoor temperature of 20°C WB and Outdoor temperature of 7°C DB / 6°C WB

The data in this catalogue is purely indicative as the data may vary.
Please be advised to check the accuracy of the data with the supplier before purchasing products.



42-46HP

AV14IMVURA

AV16IMVURA

AV20IMVURA

AV22IMVURA

Model		AV42IMVURA AV20IMVURA AV22IMVURA	AV44IMVURA AV22IMVURA AV22IMVURA	AV46IMVURA AV14IMVURA AV16IMVURA AV16IMVURA
Capacity				
Power Class	HP	42	44	46
Cooling	kW	116,00	120,00	130,00
Heating	kW	116,00	120,00	130,00
Electrical Parameters				
Power supply	Ph/V/Hz	3/380-400/50/60 (5 wires L1+L2+L3+N+T)	3/380-400/50/60 (5 wires L1+L2+L3+N+T)	3/380-400/50/60 (5 wires L1+L2+L3+N+T)
Absorbed power - Cooling	kW	42,51	44,44	40,17
Max absorbed power - Cooling	kW	65,00	66,00	69,40
Absorbed current in cooling.	A	61,49	66,06	66,34
Max absorbed current - Cooling	A	107,35	109,00	114,61
Absorbed power - Heating	kW	33,69	35,82	33,31
Max absorbed power - Heating	kW	59,80	60,80	63,80
Absorbed current in heating	A	55,62	59,16	55,01
Max absorbed current - Heating	A	98,76	100,41	105,37
EER energy class	W/W	2,73	2,70	3,24
COP energy class	W/W	3,44	3,35	3,90
SEER energy class	W/W	5,63	5,63	6,37
SCOP energy class	W/W	3,50	3,50	3,77
η _{s,c} %		222	222	252
η _{s,h} %		137	137	148
Ventilation				
Air flow (High)	m ³ /h	38000	38000	47500
Sound pressure level (High)	dB(A)	67	67	67
Sound power level (High)	dB(A)	93	93	92
Installation - Dimensions - Components				
Unit Dimensions WxDxH	mm	1410x750x1690 + 1410x750x1690		980x750x1690 + 1410x750x1690 + 1410x750x1690
Packaged unit dimensions WxDxH	mm	1515x850x1858 + 1515x850x1858		1070x850x1838 + 1515x850x1838 + 1515x850x1838
Net weight / Gross weight	Kg	375/404 + 375/404		257/282 + 366/395 + 366/395
Compressor type		DC Inverter Scroll	DC Inverter Scroll	DC Inverter Scroll
Quantity and type of the compressor	No.	4 INV	4 INV	5 INV
Refrigerant type		R410A	R410A	R410A
Pre-charged refrigerant qty.	Kg	20	20	30
Ø Liquid side refrigerant pipe	mm (inch)	19,05 (3/4)	19,05 (3/4)	19,05 (3/4)
Ø Gas recovery side refrigerant pipe	mm (inch)	38,10 (1-1/2)	38,10 (1-1/2)	38,10 (1-1/2)
Ø High-pressure refrigerant gas pipe	mm (inch)	34,9 (1-3/8)	34,9 (1-3/8)	34,9 (1-3/8)
Maximum piping length	m	1000	1000	1000
Max linear piping length (Equivalent/Real)	m	260/220	260/220	260/220
Max. drop between IU and OU (O.U. down/up)*1	m	110/90	110/90	110/90
Std. drop between IU and OU (O.U. up/down)*2		50/40	50/40	50/40
Max. drop between IU *3	m	30	30	30
Std. drop between IU *4		18	18	18
Static Pressure Fans	Pa	110	110	110
Connectable Indoor Capacity Ratio				
Indoor / Outdoor Capacity Ratio	%	50 - 130	50 - 130	50 - 130
Maximum number of connectable IUs	No.	64	64	64
External Temperature Operating Limits				
Cooling	°C	-5-50	-5-50	-5-50
Heating	°C	-23-21	-23-21	-23-21

The specifications indicated are obtained with the following test conditions: in Cooling mode, Indoor temperature of 27°C DB / 19°C WB and Outdoor temperature of 35°C DB / 24°C WB. In Heating mode, Indoor temperature of 20°C WB and Outdoor temperature of 7°C DB / 6°C WB

Outdoor Units

MRV5-RC

DC INVERTER



48-56HP

AV16IMVURA

AV18IMVURA

AV20IMVURA

Model		AV48IMVURA AV16IMVURA AV16IMVURA AV16IMVURA	AV50IMVURA AV16IMVURA AV16IMVURA AV18IMVURA	AV52IMVURA AV16IMVURA AV18IMVURA AV18IMVURA	AV54IMVURA AV18IMVURA AV18IMVURA AV18IMVURA	AV56IMVURA AV18IMVURA AV18IMVURA AV20IMVURA
Capacity						
Power Class	HP	48	50	52	54	56
Cooling	kW	135,00	140,00	145,00	150,00	156,00
Heating	kW	135,00	140,00	145,00	150,00	156,00
Electrical Parameters						
Power supply	Ph/V/Hz	3/380-400/50/60 (5 wires L1+L2+L3+N+T)	3/380-400/50/60 (5 wires L1+L2+L3+N+T)	3/380-400/50/60 (5 wires L1+L2+L3+N+T)	3/380-400/50/60 (5 wires L1+L2+L3+N+T)	3/380-400/50/60 (5 wires L1+L2+L3+N+T)
Absorbed power - Cooling	kW	41,80	43,99	46,19	48,39	52,55
Max absorbed power - Cooling	kW	75,30	78,70	82,10	85,50	89,00
Absorbed current in cooling.	A	69,03	72,65	76,28	79,91	81,73
Max absorbed current - Cooling	A	124,36	129,97	135,59	141,20	146,98
Absorbed power - Heating	kW	34,18	36,48	38,79	41,10	43,17
Max absorbed power - Heating	kW	68,10	70,90	73,70	76,50	80,40
Absorbed current in heating	A	56,44	60,25	64,06	67,87	71,29
Max absorbed current - Heating	A	112,47	117,09	121,72	126,34	132,78
EER energy class	W/W	3,23	3,18	3,14	3,10	2,97
COP energy class	W/W	3,95	3,84	3,74	3,65	3,61
SEER energy class	W/W	6,86	6,48	6,48	6,48	5,78
SCOP energy class	W/W	4,21	3,99	3,99	3,99	3,93
η _{s,c} %		271	256	256	256	228
η _{s,h} %		165	157	157	157	154
Ventilation						
Air flow (High)	m ³ /h	51000	51000	51000	51000	53000
Sound pressure level (High)	dB(A)	67	67	68	68	68
Sound power level (High)	dB(A)	93	93	93	94	94
Installation - Dimensions - Components						
Unit Dimensions WxDxH	mm	1410x750x1690+1410x750x1690+1410x750x1690				
Packaged unit dimensions WxDxH	mm	1485x850x1858+1485x850x1858+1485x850x1858				
Net weight / Gross weight	Kg	366/395+366/395+366/395				366/395 + 366/395 + 375/404
Compressor type		DC Inverter Scroll	DC Inverter Scroll	DC Inverter Scroll	DC Inverter Scroll	DC Inverter Scroll
Quantity and type of the compressor	No.	6 INV	6 INV	6 INV	6 INV	6 INV
Refrigerant type		R410A	R410A	R410A	R410A	R410A
Pre-charged refrigerant qty.	Kg	30	30	30	30	30
Ø Liquid side refrigerant pipe	mm (inch)	19,05 (3/4)	19,05 (3/4)	19,05 (3/4)	19,05 (3/4)	19,05 (3/4)
Ø Gas recovery side refrigerant pipe	mm (inch)	38,10 (1-1/2)	38,10 (1-1/2)	38,10 (1-1/2)	38,10 (1-1/2)	38,10 (1-1/2)
Ø High-pressure refrigerant gas pipe	mm (inch)	34,9 (1-3/8)	34,9 (1-3/8)	34,9 (1-3/8)	34,9 (1-3/8)	34,9 (1-3/8)
Maximum piping length	m	1000	1000	1000	1000	1000
Max linear piping length (Equivalent/Real)	m	260/220	260/220	260/220	260/220	260/220
Max. drop between IU and OU (O.U. down/up)*1	m	110/90	110/90	110/90	110/90	110/90
Std. drop between IU and OU (O.U. up/down)*2	m	50/40	50/40	50/40	50/40	50/40
Max. drop between IU *3	m	30	30	30	30	30
Std. drop between IU *4	m	18	18	18	18	18
Static Pressure Fans	Pa	110	110	110	110	110
Connectable Indoor Capacity Ratio						
Indoor / Outdoor Capacity Ratio	%	50 - 130	50 - 130	50 - 130	50 - 130	50 - 130
Maximum number of connectable IUs	No.	64	64	64	64	64
External Temperature Operating Limits						
Cooling	°C	-5-50	-5-50	-5-50	-5-50	-5-50
Heating	°C	-23-21	-23-21	-23-21	-23-21	-23-21

The specifications indicated are obtained with the following test conditions: in Cooling mode, Indoor temperature of 27°C DB / 19°C WB and Outdoor temperature of 35°C DB / 24°C WB. In Heating mode, Indoor temperature of 20°C WB and Outdoor temperature of 7°C DB / 6°C WB



58-66HP

AV18IMVURA

AV20IMVURA

AV22IMVURA

Model		AV58IMVURA AV18IMVURA AV20IMVURA AV20IMVURA	AV60IMVURA AV20IMVURA AV20IMVURA AV20IMVURA	AV62IMVURA AV20IMVURA AV20IMVURA AV22IMVURA	AV64IMVURA AV20IMVURA AV20IMVURA AV22IMVURA	AV66IMVURA AV22IMVURA AV22IMVURA AV22IMVURA
Capacity						
Power Class	HP	58	60	62	64	66
Cooling	kW	162,00	168,0	172,00	176,00	180,00
Heating	kW	162,00	168,00	172,00	176,00	180,00
Electrical Parameters						
Power supply	Ph/V/Hz	3/380-400/50/60 (5 wires L1+L2+L3+N+T)	3/380-400/50/60 (5 wires L1+L2+L3+N+T)	3/380-400/50/60 (5 wires L1+L2+L3+N+T)	3/380-400/50/60 (5 wires L1+L2+L3+N+T)	3/380-400/50/60 (5 wires L1+L2+L3+N+T)
Absorbed power - Cooling	kW	56,71	60,87	62,80	64,73	66,66
Max absorbed power - Cooling	kW	92,50	96,00	97,00	98,00	99,00
Absorbed current in cooling.	A	83,55	85,37	89,94	94,52	99,09
Max absorbed current - Cooling	A	152,76	158,54	160,20	161,85	163,50
Absorbed power - Heating	kW	45,25	47,31	49,45	51,59	53,73
Max absorbed power - Heating	kW	84,30	88,20	89,20	90,20	91,20
Absorbed current in heating	A	74,71	78,13	81,67	85,20	88,74
Max absorbed current - Heating	A	139,22	145,66	147,31	148,97	150,62
EER energy class	W/W	2,86	2,76	2,74	2,72	2,70
COP energy class	W/W	3,58	3,55	3,48	3,41	3,35
SEER energy class	W/W	5,78	5,78	5,63	5,63	5,63
SCOP energy class	W/W	3,93	3,93	3,50	3,50	3,50
ηs,c %		288	288	222	222	222
ηs,h %		154	154	137	137	137
Ventilation						
Air flow (High)	m³/h	55000	57000	57000	57000	57000
Sound pressure level (High)	dB(A)	68	68	68	69	69
Sound power level (High)	dB(A)	94	94	94	94	95
Installation - Dimensions - Components						
Unit Dimensions WxDxH	mm	1410x750x1690+1410x750x1690+1410x750x1690				
Packaged unit dimensions WxDxH	mm	1485x850x1858+1485x850x1858+1485x850x1858				
Net weight / Gross weight	Kg	366/395 + 375/404 + 375/404	375/404 + 375/404 + 375/404			
Compressor type		DC Inverter Scroll	DC Inverter Scroll	DC Inverter Scroll	DC Inverter Scroll	DC Inverter Scroll
Quantity and type of the compressor	No.	6 INV	6 INV	6 INV	6 INV	6 INV
Refrigerant type		R410A	R410A	R410A	R410A	R410A
Pre-charged refrigerant qty.	Kg	30	30	30	30	30
Ø Liquid side refrigerant pipe	mm (inch)	19,05 (3/4)	19,05 (3/4)	19,05 (3/4)	19,05 (3/4)	19,05 (3/4)
Ø Gas recovery side refrigerant pipe	mm (inch)	41,30 (1-5/8)	41,30 (1-5/8)	41,30 (1-5/8)	41,30 (1-5/8)	41,30 (1-5/8)
Ø High-pressure refrigerant gas pipe	mm (inch)	38,10 (1-1/2)	38,10 (1-1/2)	38,10 (1-1/2)	38,10 (1-1/2)	38,10 (1-1/2)
Maximum piping length	m	1000	1000	1000	1000	1000
Max linear piping length (Equivalent/Real)	m	260/220	260/220	260/220	260/220	260/220
Max. drop between IU and OU (O.U. down/up)*1	m	110/90	110/90	110/90	110/90	110/90
Std. drop between IU and OU (O.U. up/down)*2	m	50/40	50/40	50/40	50/40	50/40
Max. drop between IU *3	m	30	30	30	30	30
Std. drop between IU *4	m	18	18	18	18	18
Static Pressure Fans	Pa	110	110	110	110	110
Connectable Indoor Capacity Ratio						
Indoor / Outdoor Capacity Ratio	%	50 – 130	50 – 130	50 – 130	50 – 130	50 – 130
Maximum number of connectable IUs	No.	64	64	64	64	64
External Temperature Operating Limits						
Cooling	°C	-5-50	-5-50	-5-50	-5-50	-5-50
Heating	°C	-23-21	-23-21	-23-21	-23-21	-23-21

The specifications indicated are obtained with the following test conditions: in Cooling mode, Indoor temperature of 27°C DB / 19°C WB and Outdoor temperature of 35°C DB / 24°C WB. In Heating mode, Indoor temperature of 20°C WB and Outdoor temperature of 7°C DB / 6°C WB

Outdoor Units

MRV5-RC

DC INVERTER



68-74HP

AV16IMVURA
AV18IMVURA
AV20IMVURA

Model		AV68IMVURA AV16IMVURA AV16IMVURA AV18IMVURA AV18IMVURA	AV70IMVURA AV16IMVURA AV18IMVURA AV18IMVURA AV18IMVURA	AV72IMVURA AV18IMVURA AV18IMVURA AV18IMVURA AV18IMVURA	AV74IMVURA AV18IMVURA AV18IMVURA AV18IMVURA AV20IMVURA
Capacity					
Power Class	HP	68	70	72	74
Cooling	kW	190,00	195,00	200,00	206,00
Heating	kW	190,00	195,00	200,00	206,00
Electrical Parameters					
Power supply	Ph/V/Hz	3/380-400/50/60 (5 wires L1+L2+L3+N+T)		3/380-400/50/60 (5 wires L1+L2+L3+N+T)	
Absorbed power - Cooling	kW	60,12	62,32	64,52	65,62
Max absorbed power - Cooling	kW	107,20	110,60	114,00	117,50
Absorbed current in cooling	A	99,29	102,92	106,55	108,37
Max absorbed current - Cooling	A	177,04	182,66	188,27	194,05
Absorbed power – Heating	kW	50,18	52,49	54,79	56,87
Max absorbed power – Heating	kW	96,40	99,20	102,00	105,90
Absorbed current in heating	A	82,88	86,68	90,49	93,91
Max absorbed current – Heating	A	159,21	163,83	168,45	174,89
EER energy class	W/W	3,16	3,13	3,10	3,00
COP energy class	W/W	3,79	3,72	3,65	3,62
SEER energy class	W/W	6,48	6,48	6,48	5,78
SCOP energy class	W/W	3,99	3,99	3,99	3,93
η _{s,c} %		256	256	256	228
η _{s,h} %		157	157	157	154
Ventilation					
Air flow (High)	m ³ /h	68000	68000	68000	70000
Sound pressure level (High)	dB(A)	69	69	69	69
Sound power level (High)	dB(A)	95	95	95	95
Installation - Dimensions - Components					
Unit Dimensions WxDxH	mm	1410x750x1690+1410x750x1690+1410x750x1690+1410x750x1690			
Packaged unit dimensions WxDxH	mm	1515x850x1858+1515x850x1858+1515x850x1858+1515x850x1858			
Net weight / Gross weight	Kg	366/395+366/395+366/395+366/395			366/395 + 366/395 + 366/395 + 375/404
Compressor type		DC Inverter Scroll	DC Inverter Scroll	DC Inverter Scroll	DC Inverter Scroll
Quantity and type of the compressor	No.	8 INV	8 INV	8 INV	8 INV
Refrigerant type		R410A	R410A	R410A	R410A
Pre-charged refrigerant qty.	Kg	40	40	40	40
Ø Liquid side refrigerant pipe	mm (inch)	22,20 (7/8)	22,20 (7/8)	22,20 (7/8)	22,20 (7/8)
Ø Gas recovery side refrigerant pipe	mm (inch)	44,50 (1-3/4)	44,50 (1-3/4)	44,50 (1-3/4)	44,50 (1-3/4)
Ø High-pressure refrigerant gas pipe	mm (inch)	41,30 (1-5/8)	41,30 (1-5/8)	41,30 (1-5/8)	41,30 (1-5/8)
Maximum piping length	m	1000	1000	1000	1000
Max linear piping length (Equivalent/Real)	m	260/220	260/220	260/220	260/220
Max. drop between IU and OU (O.U. down/up)*1	m	110/90	110/90	110/90	110/90
Std. drop between IU and OU (O.U. up/down)*2		50/40	50/40	50/40	50/40
Max. drop between IU *3	m	30	30	30	30
Std. drop between IU *4		18	18	18	18
Static Pressure Fans	Pa	110	110	110	110
Connectable Indoor Capacity Ratio					
Indoor / Outdoor Capacity Ratio	%	50 – 130	50 – 130	50 – 130	50 – 130
Maximum number of connectable IUs	No.	64	64	64	64
External Temperature Operating Limits					
Cooling	°C	-5-50	-5-50	-5-50	-5-50
Heating	°C	-23-21	-23-21	-23-21	-23-21

The specifications indicated are obtained with the following test conditions: in Cooling mode, Indoor temperature of 27°C DB / 19°C WB and Outdoor temperature of 35°C DB / 24°C WB. In Heating mode, Indoor temperature of 20°C WB and Outdoor temperature of 7°C DB / 6°C WB



76-82HP

AV18IMVURA

AV20IMVURA

AV22IMVURA

Model		AV76IMVURA AV18IMVURA AV18IMVURA AV20IMVURA AV20IMVURA	AV78IMVURA AV18IMVURA AV20IMVURA AV20IMVURA AV20IMVURA	AV80IMVURA AV20IMVURA AV20IMVURA AV20IMVURA AV20IMVURA	AV82IMVURA AV20IMVURA AV20IMVURA AV20IMVURA AV22IMVURA
Capacity					
Power Class	HP	76	78	80	82
Cooling	kW	212.00	218.00	224.00	228.00
Heating	kW	212.00	218.00	224.00	228.00
Electrical Parameters					
Power supply	Ph/V/Hz	3/380-400/50/60 (5 wires L1+L2+L3+N+T)		3/380-400/50/60 (5 wires L1+L2+L3+N+T)	
Absorbed power - Cooling	kW	72.84	77.00	81.16	83.09
Max absorbed power - Cooling	kW	121.00	124.50	128.00	129.00
Absorbed current in cooling.	A	110.19	112.01	113.83	118.40
Max absorbed current - Cooling	A	199.83	205.61	211.39	213.04
Absorbed power - Heating	kW	58.94	61.01	63.08	65.22
Max absorbed power - Heating	kW	109.80	113.70	117.60	118.60
Absorbed current in heating	A	97.34	100.76	104.18	107.71
Max absorbed current - Heating	A	181.34	187.78	194.22	195.87
EER energy class	W/W	2.91	2.83	2.76	2.74
COP energy class	W/W	3.60	3.57	3.55	3.50
SEER energy class	W/W	5.78	5.78	5.78	5.63
SCOP energy class	W/W	3.93	3.93	3.93	3.50
ηs,c %		288	288	233	222
ηs,h %		154	154	154	137
Ventilation					
Air flow (High)	m³/h	72000	74000	76000	76000
Sound pressure level (High)	dB(A)	69	69	69	69
Sound power level (High)	dB(A)	95	95	95	95
Installation - Dimensions - Components					
Unit Dimensions WxDxH	mm	1410x750x1690+1410x750x1690+1410x750x1690+1410x750x1690			
Packaged unit dimensions WxDxH	mm	1515x850x1858+1515x850x1858+1515x850x1858+1515x850x1858			
Net weight / Gross weight	Kg	366/395 + 366/395 + 375/404 + 375/404	366/395 + 375/404 + 375/404 + 375/404	375/404+375/404+375/404+375/404	
Compressor type		DC Inverter Scroll	DC Inverter Scroll	DC Inverter Scroll	DC Inverter Scroll
Quantity and type of the compressor	No.	8 INV	8 INV	8 INV	8 INV
Refrigerant type		R410A	R410A	R410A	R410A
Pre-charged refrigerant qty.	Kg	40	40	40	40
Ø Liquid side refrigerant pipe	mm (inch)	22.20 (7/8)	22.20 (7/8)	22.20 (7/8)	22.20 (7/8)
Ø Gas recovery side refrigerant pipe	mm (inch)	44.50 (1-3/4)	44.50 (1-3/4)	44.50 (1-3/4)	44.50 (1-3/4)
Ø High-pressure refrigerant gas pipe	mm (inch)	41.30 (1-5/8)	41.30 (1-5/8)	41.30 (1-5/8)	41.30 (1-5/8)
Maximum piping length	m	1000	1000	1000	1000
Max linear piping length (Equivalent/Real)	m	260/220	260/220	260/220	260/220
Max. drop between IU and OU (O.U. down/up)*1	m	110/90	110/90	110/90	110/90
Std. drop between IU and OU (O.U. up/down)*2	m	50/40	50/40	50/40	50/40
Max. drop between IU *3	m	30	30	30	30
Std. drop between IU *4	m	18	18	18	18
Static Pressure Fans	Pa	110	110	110	110
Connectable Indoor Capacity Ratio					
Indoor / Outdoor Capacity Ratio	%	50 - 130	50 - 130	50 - 130	50 - 130
Maximum number of connectable IUs	No.	64	64	64	64
External Temperature Operating Limits					
Cooling	°C	-5-50	-5-50	-5-50	-5-50
Heating	°C	-23-21	-23-21	-23-21	-23-21

The specifications indicated are obtained with the following test conditions: in Cooling mode, Indoor temperature of 27°C DB / 19°C WB and Outdoor temperature of 35°C DB / 24°C WB. In Heating mode, Indoor temperature of 20°C WB and Outdoor temperature of 7°C DB / 6°C WB

Outdoor Units

MRV5-RC

DC INVERTER

Haier



84-88HP

AV20IMVURA

AV22IMVURA

Model		AV84IMVURA AV20IMVURA AV20IMVURA AV22IMVURA AV22IMVURA	AV86IMVURA AV20IMVURA AV22IMVURA AV22IMVURA AV22IMVURA	AV88IMVURA AV22IMVURA AV22IMVURA AV22IMVURA AV22IMVURA
Capacity				
Power Class	HP	84	86	88
Cooling	kW	232,00	236,00	240,00
Heating	kW	232,00	236,00	240,00
Electrical Parameters				
Power supply	Ph/V/Hz	3/380-400/50/60 (5 wires L1+L2+L3+N+T)	3/380-400/50/60 (5 wires L1+L2+L3+N+T)	3/380-400/50/60 (5 wires L1+L2+L3+N+T)
Absorbed power - Cooling	kW	85,02	86,95	88,88
Max absorbed power - Cooling	kW	130,00	131,00	132,00
Absorbed current in cooling.	A	122,97	127,55	132,12
Max absorbed current - Cooling	A	214,70	216,35	218,00
Absorbed power – Heating	kW	67,36	69,50	71,64
Max absorbed power – Heating	kW	119,60	120,60	121,60
Absorbed current in heating	A	111,25	114,78	118,31
Max absorbed current – Heating	A	197,52	199,17	200,82
EER energy class	W/W	2,73	2,71	2,70
COP energy class	W/W	3,44	3,40	3,35
SEER energy class	W/W	5,63	5,63	5,63
SCOP energy class	W/W	3,50	3,50	3,50
$\eta_{s,c}$ %		222	222	222
$\eta_{s,h}$ %		137	137	137
Ventilation				
Air flow (High)	m ³ /h	76000	76000	76000
Sound pressure level (High)	dB(A)	70	70	70
Sound power level (High)	dB(A)	96	96	96
Installation - Dimensions - Components				
Unit Dimensions WxDxH	mm	1410x750x1690+1410x750x1690+1410x750x1690+1410x750x1690		
Packaged unit dimensions WxDxH	mm	1515x850x1858+1515x850x1858+1515x850x1858+1515x850x1858		
Net weight / Gross weight	Kg	375/404+375/404+375/404+375/404		
Compressor type		DC Inverter Scroll	DC Inverter Scroll	DC Inverter Scroll
Quantity and type of the compressor	No.	8 INV	8 INV	8 INV
Refrigerant type		R410A	R410A	R410A
Pre-charged refrigerant qty.	Kg	40	40	40
Ø Liquid side refrigerant pipe	mm (inch)	22,20 (7/8)	25,40 (1)	25,40 (1)
Ø Gas recovery side refrigerant pipe	mm (inch)	44,50 (1-3/4)	50,80 (2)	50,80 (2)
Ø High-pressure refrigerant gas pipe	mm (inch)	41,30 (1-5/8)	44,50 (1-3/4)	44,50 (1-3/4)
Maximum piping length	m	1000	1000	1000
Max linear piping length (Equivalent/Real)	m	260/220	260/220	260/220
Max. drop between IU and OU (O.U. down/up)*1	m	110/90	110/90	110/90
Std. drop between IU and OU (O.U. up/down)*2	m	50/40	50/40	50/40
Max. drop between IU *3	m	30	30	30
Std. drop between IU *4	m	18	18	18
Static Pressure Fans	Pa	110	110	110
Connectable Indoor Capacity Ratio				
Indoor / Outdoor Capacity Ratio	%	50 – 130	50 – 130	50 – 130
Maximum number of connectable IUs	No.	64	64	64
External Temperature Operating Limits				
Cooling	°C	-5-50	-5-50	-5-50
Heating	°C	-23-21	-23-21	-23-21

The specifications indicated are obtained with the following test conditions: in Cooling mode, Indoor temperature of 27°C DB / 19°C WB and Outdoor temperature of 35°C DB / 24°C WB. In Heating mode, Indoor temperature of 20°C WB and Outdoor temperature of 7°C DB / 6°C WB

The data in this catalogue is purely indicative as the data may vary.
Please be advised to check the accuracy of the data with the supplier before purchasing products.

MRV OUTDOOR UNITS

AV08IM**A AV10IM**A AV12IM**A AV14IM**A AV16IM**A

Unit:mm

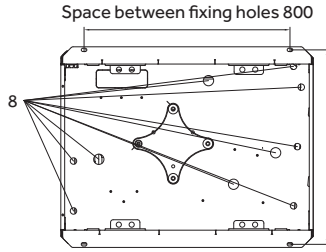

Space between fixing holes 755

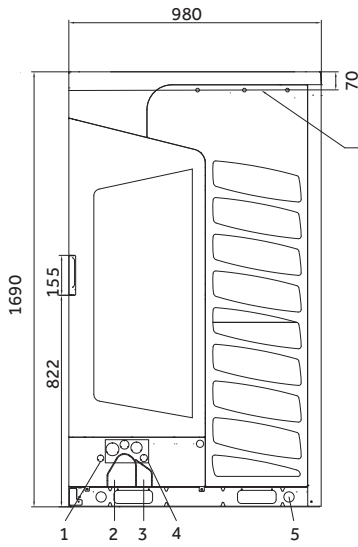
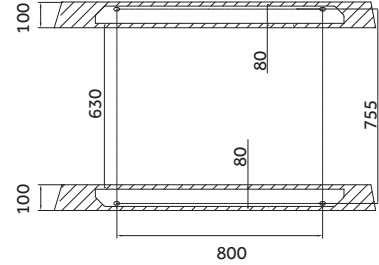

Air outlet duct connection position

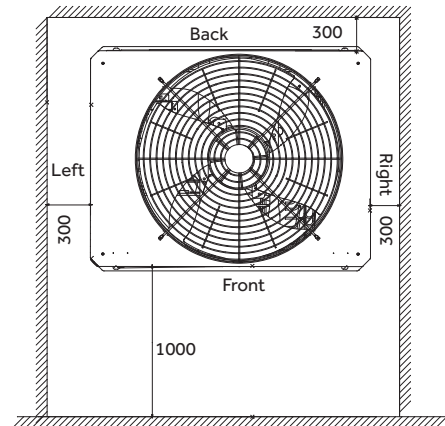
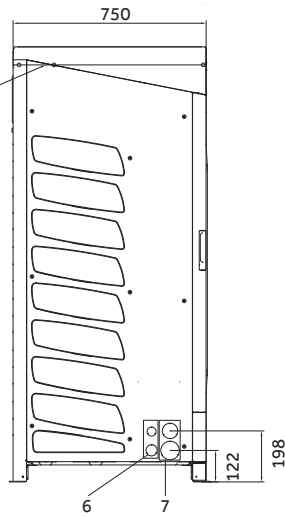

(*1) 50 m when the outdoor unit is above the indoor unit / 40 m when it is below

The specifications indicated are obtained with the following test conditions: in Cooling mode, Indoor temperature of 27°C WB / 19°C DB and Outdoor temperature of 35°C WB / 24°C DB. In Heating mode, Indoor temperature of 20°C WB and Outdoor temperature of 7°C WB / 6°C DB

Outdoor Units

MRV5-RC

DC INVERTER

MRV OUTDOOR UNITS

AV18IM**A AV20IM**A AV22IM**A AV24IM**A AV26IM**A

Unit:mm

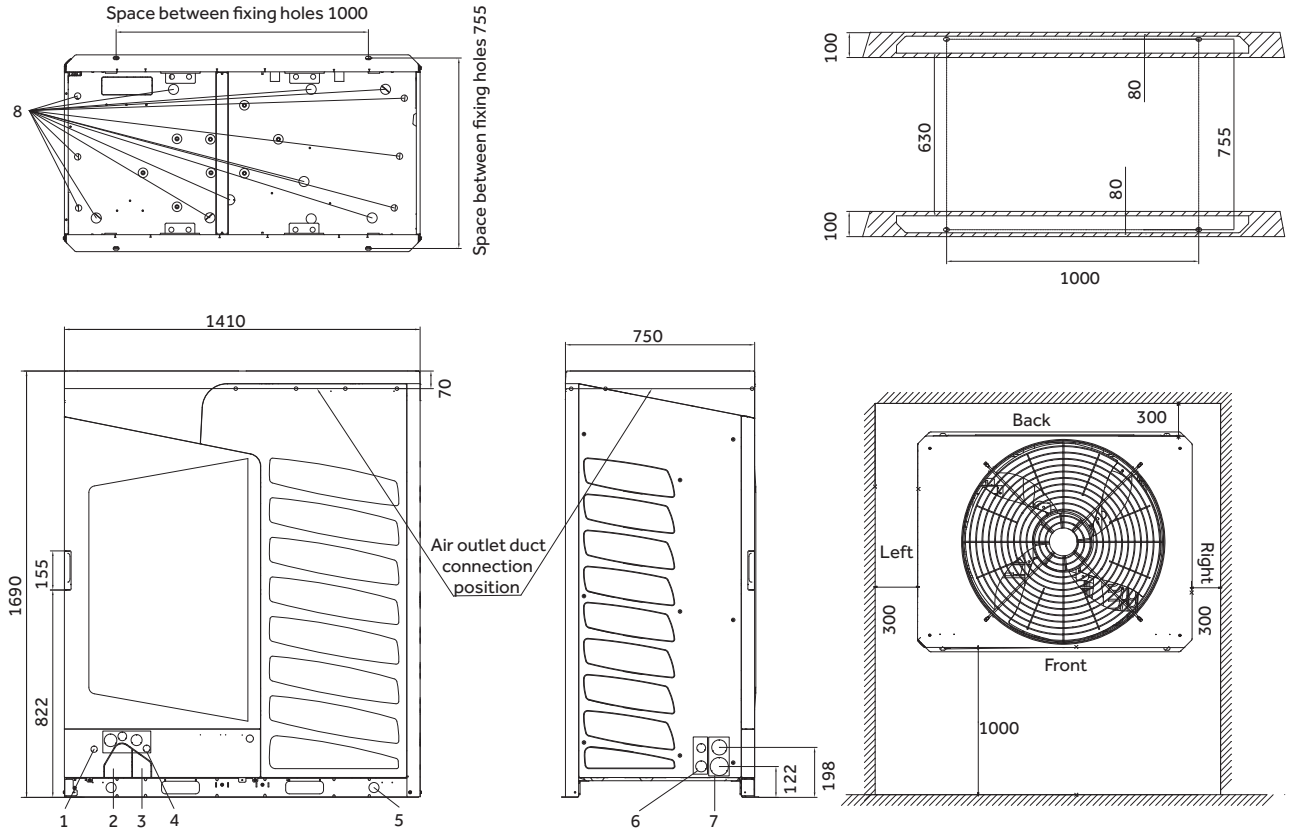

(*1) 50 m when the outdoor unit is above the indoor unit / 40 m when it is below
 The specifications indicated are obtained with the following test conditions: in Cooling mode, Indoor temperature of 27°C WB / 19°C DB and Outdoor temperature of 35°C WB / 24°C DB. In Heating mode, Indoor temperature of 20°C WB and Outdoor temperature of 7°C WB / 6°C DB

The data in this catalogue is purely indicative as the data may vary.
 Please be advised to check the accuracy of the data with the supplier before purchasing products.



MRV W

Heat Pump System
Full DC Inverter
Water Cooled

MRV-W - FEATURES

OPERATING PRINCIPLE

MRV-W are MRV/VRF systems with direct refrigerant expansion and inverter compressors that use the same indoor units as the classic MRV systems, controls and joints.

The design and implementation of the internal circuit follows the same rules as a normal MRV/VRF system, the only difference is that they use water and not air to condense or evaporate on the outdoor unit. MRV-W therefore does not have fans and large air/refrigerant exchangers but uses special water/refrigerant exchangers. This allows to significantly reduce the size of the product compared to a classic MRV of equal cooling capacity.

Thanks to its small footprint, of only W 775 x D 545 x H 995, the installation of the MRV-W takes place inside technical rooms, basements, garages and corridors as it does not need to exchange energy with the outdoor air.

The water needed for operation reaches the units through small diameter pipes. Water can have different origins such as ground water, lake, sea, river, end industrial processes, accumulation of non-drinking water.

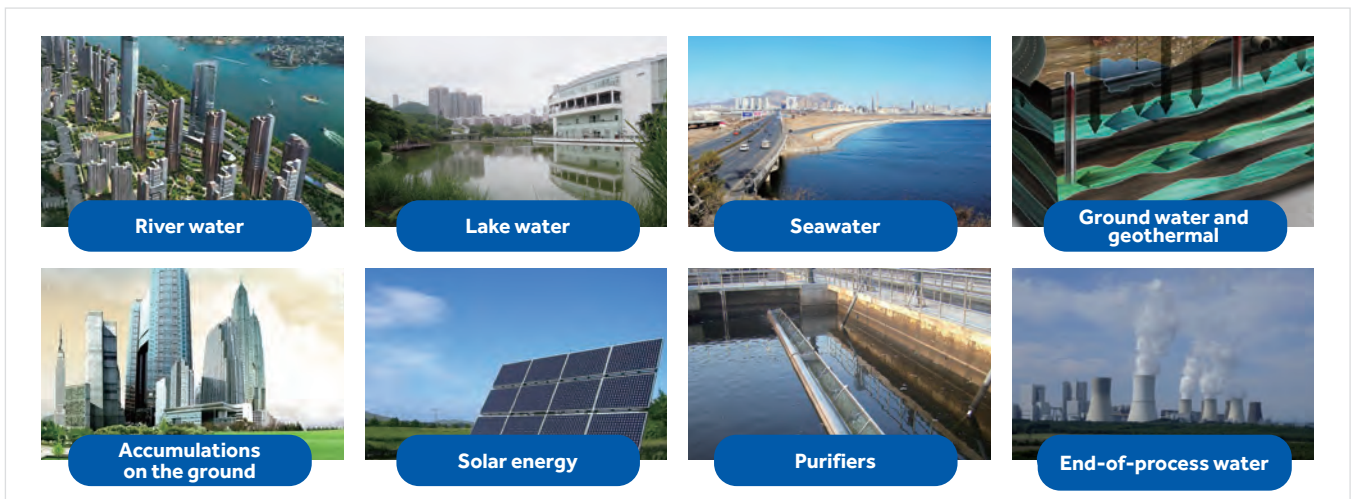
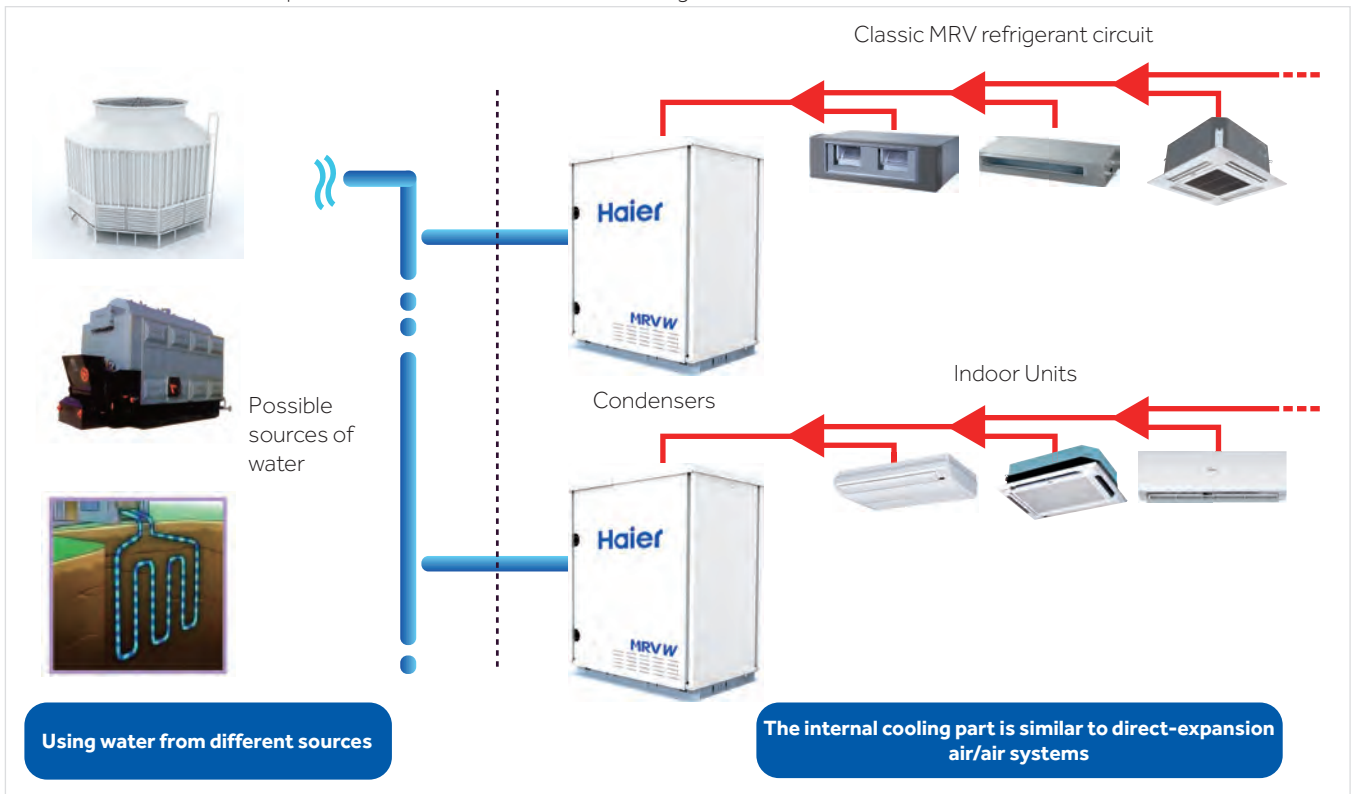

CONFIGURATION

MRV-W is a direct expansion system that combines the efficiency of the VRF technology with the use of water from a variety of sources.



EXAMPLE OF COOLING OPERATION

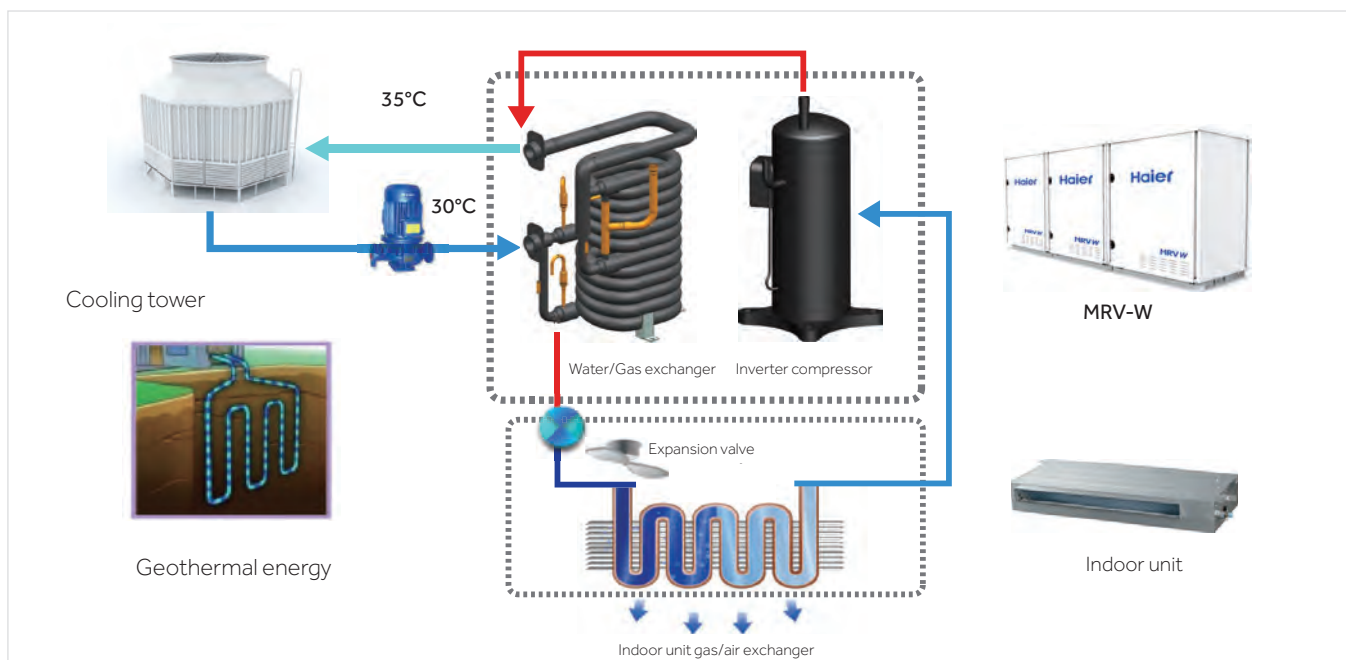

EXAMPLE OF HEATING OPERATION

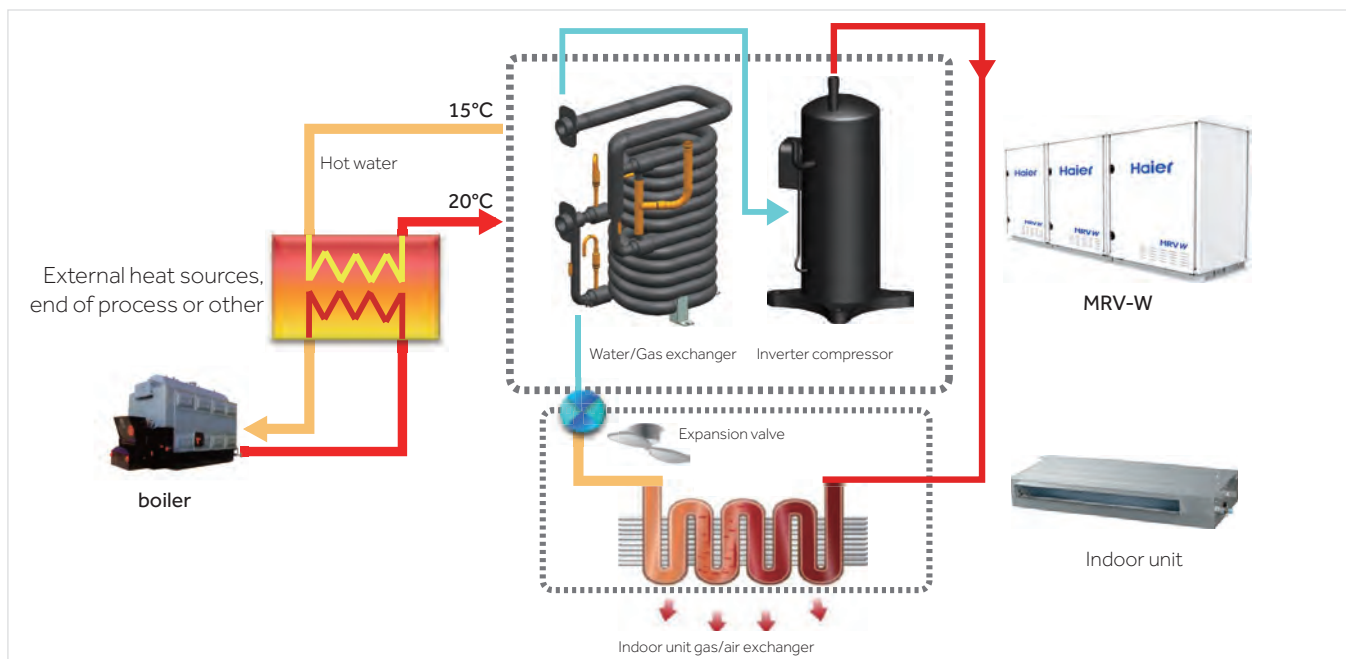

MRV-W - FEATURES

MRV-W INTERNAL STRUCTURE

Refrigerant connections to indoor units

Water entry and exit to the gas/water exchanger

Electrical, compact and easily removable panel to access the compressor

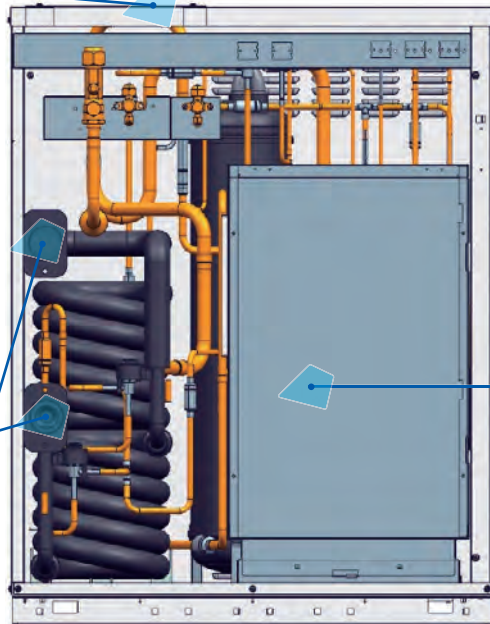

DC Inverter Compressor

Generous gas separator and liquid refrigerant side.

Double-wrapped "pipe in pipe" gas water exchanger in counter flow, great efficiency and uniformity of exchange.

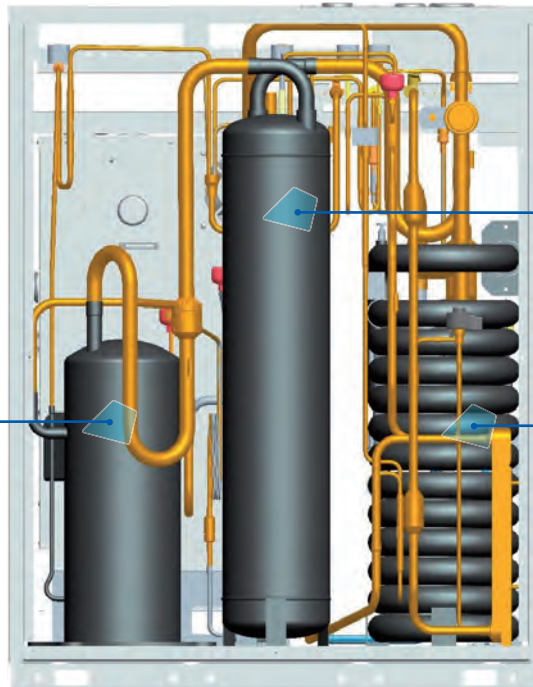

HIGH EFFICIENCY

Using a constant source, the COP can also reach values of 6.02, much higher than an air/air system. As a result, EER values are also increased in equal proportion.

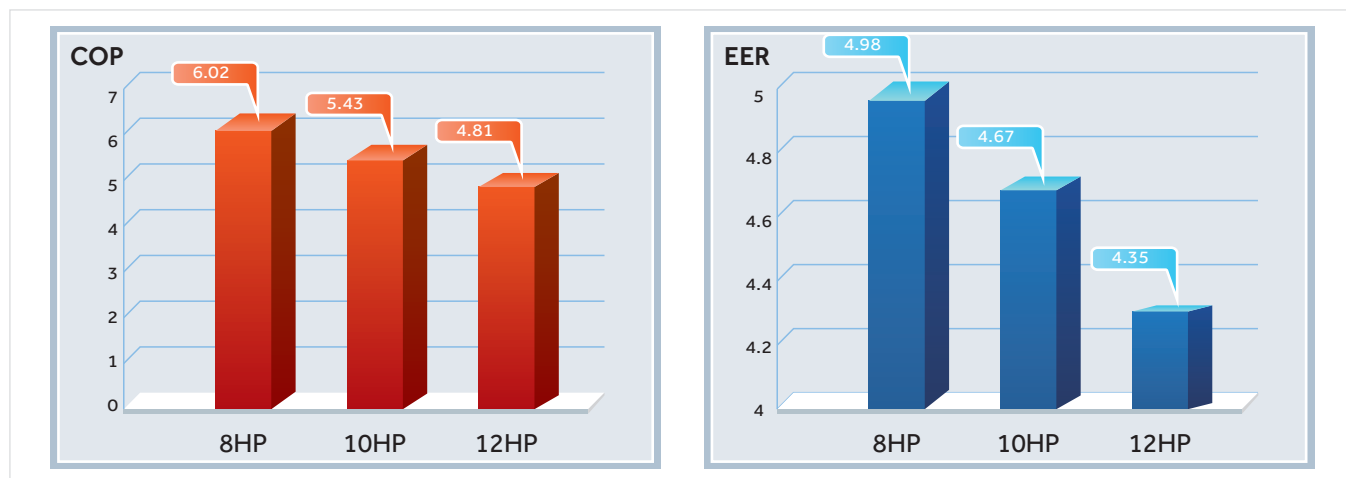

HIGH-EFFICIENCY COMPRESSOR

DC Inverter Scroll



COUNTER CURRENT "PIPE IN PIPE" EXCHANGER

Water circulates inside and refrigerant circulates outside. The internal star-section and spiral tube offers a greater exchange surface than a classic circular section, for the benefit of efficiency.

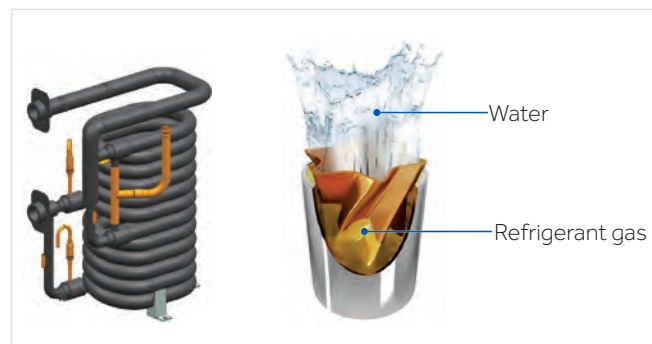

DUAL ELECTRONIC EXPANSION VALVE

To modulate the surface of the active exchanger according to the thermal demand.

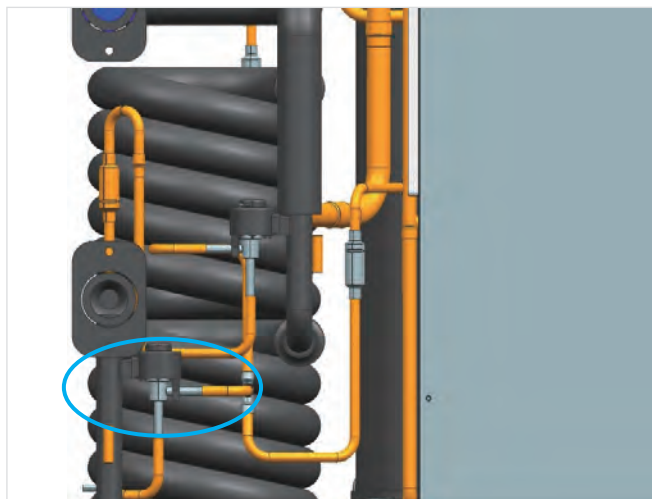

2-SIDED SUB-COOLING SYSTEM

- The first stage acts on the condenser
- The second stage acts independently
- The independent or joint activity of the two stages allows to increase the exchange of refrigerant by 46% and to reduce the loss of load through the pipes by 55%, leading to an increase in overall efficiency of 9% compared to single circuits "Under cooling"

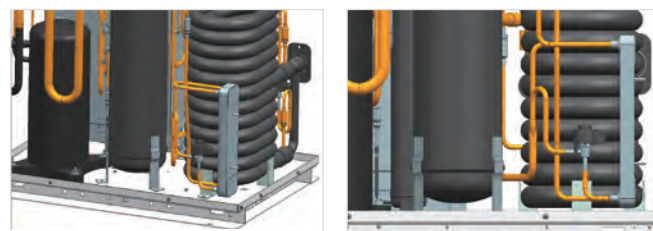

MRV-W - FEATURES

COOLING ELECTRONIC CIRCUITS

The circuits are cooled by special static exchangers where the refrigerant gas circulates inside. This allows you to cool and keep the temperature of the electric panel and power modules constant, avoiding cumbersome sinks and especially the use of noisy electric fans.

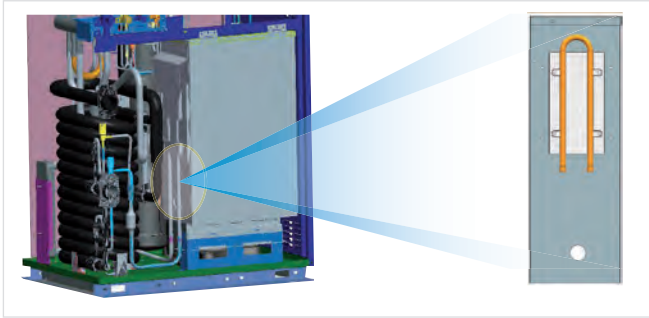

RELIABILITY

The management of the external pump or electro-valves to power the flow of water to the MRV-W systems, is controlled by the unit itself according to the activity of the compressor and the real need for water. Avoiding unnecessary waste of energy.

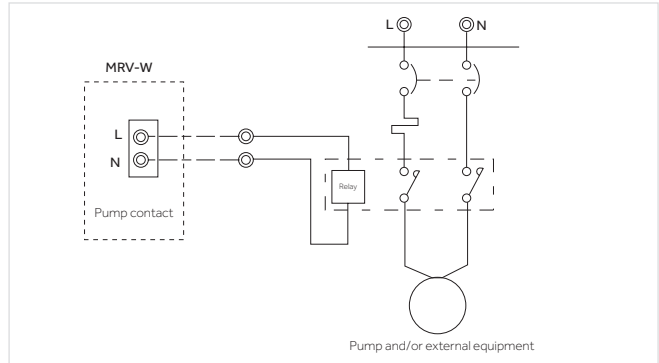

TEMPERATURE RANGE

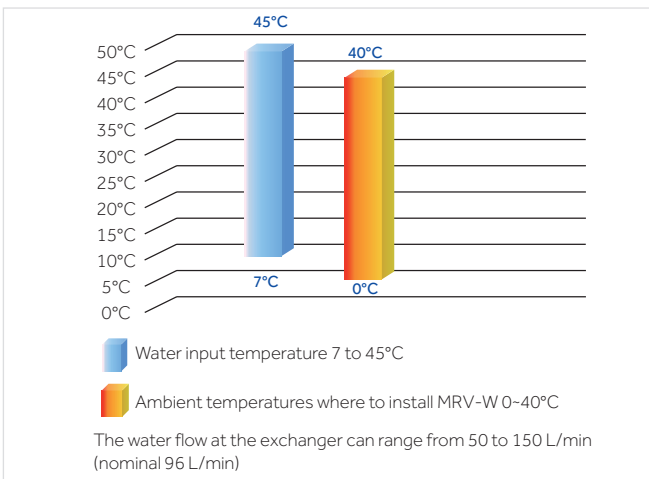

CONSTANT PRESSURE

Accurate system to maintain the pressure adequate to the compressor according to the operating temperature of the refrigerant in order to maintain a more stable output capacity and for the reliability over time of the component itself.

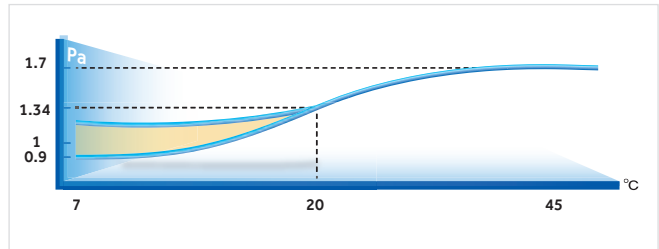

FLEXIBLE INSTALLATION

Using water as a condenser, you can air-condition very tall buildings, where you can reach up to 200 meters in height with a pressure of 1.6 MPa.

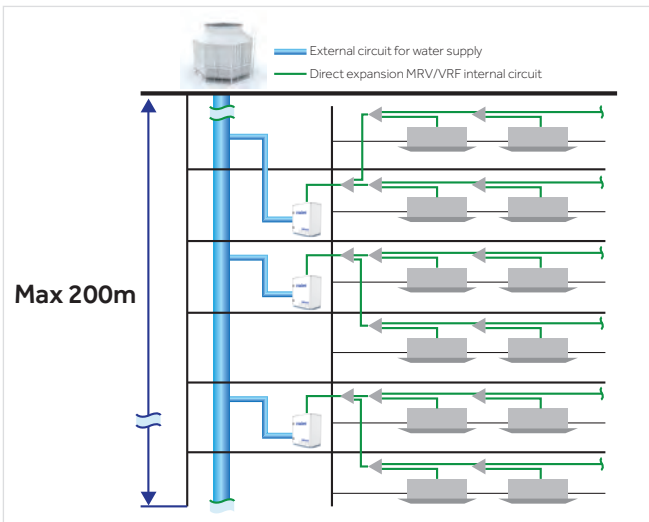

POSSIBLE ENVIRONMENTS WHERE MRV-W CAN BE INSTALLED INDOOR



MRV-W - FEATURES

EXAMPLES OF PIPING LENGTHS

Ability to achieve large elevations and lengths within each floor served by an MRV-W.

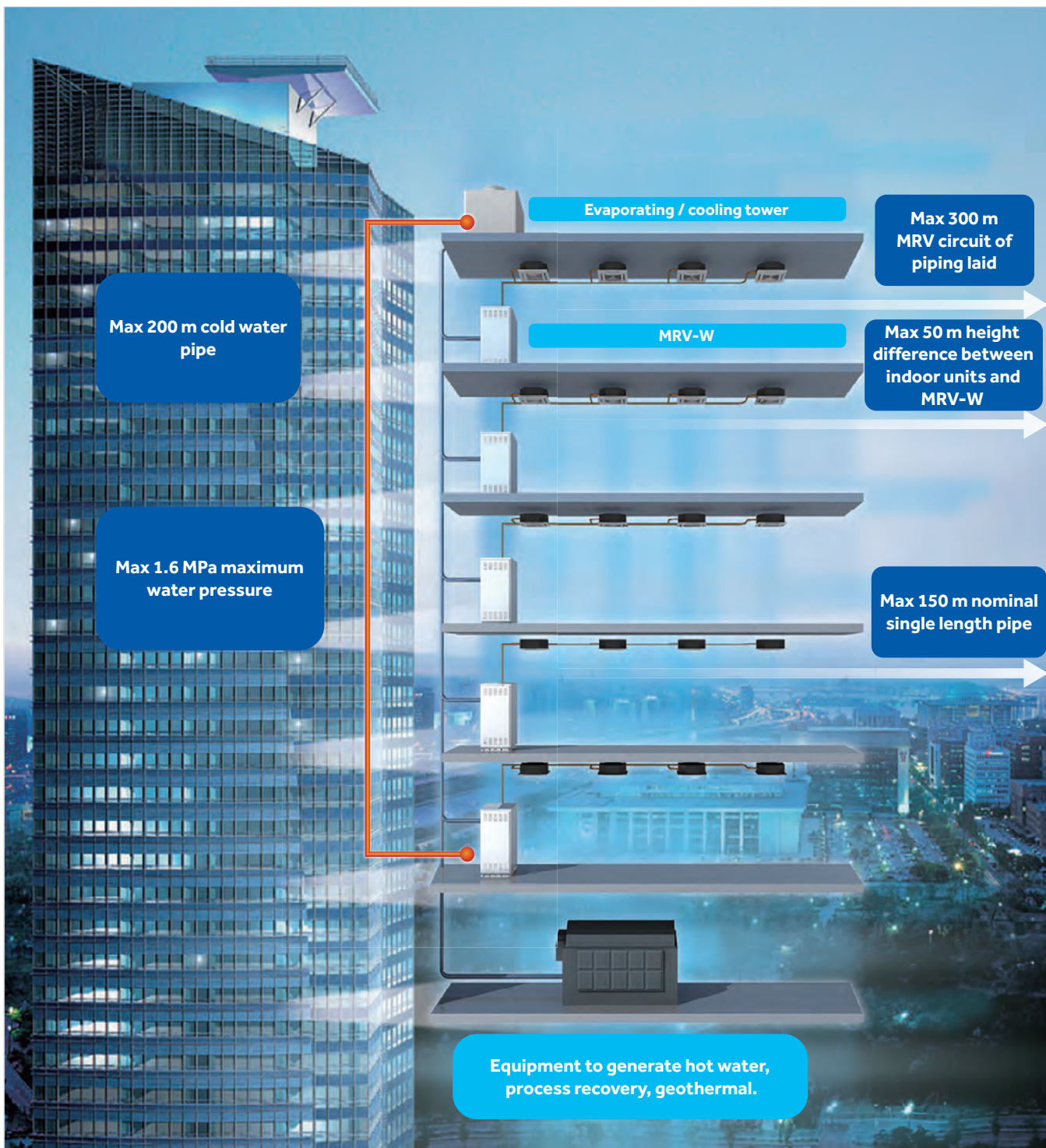



8-12HP

AV08IMWEWA

AV10IMWEWA

AV12IMWEWA

Model		AV08IMWEWA	AV10IMWEWA	AV12IMWEWA
Capacity				
Power Class	HP	8	10	12
Cooling	kW	22,40	28,00	33,50
Heating	kW	25,00	31,50	37,50
Electrical Parameters				
Power supply	Ph-V/Hz	3/380-400/50/60 (5 wires L1+L2+L3+N+T)	3/380-400/50/60 (5 wires L1+L2+L3+N+T)	3/380-400/50/60 (5 wires L1+L2+L3+N+T)
Absorbed power - Cooling	kW	4,50	6,00	7,70
Max absorbed power - Cooling	kW	13,00	15,00	17,00
Absorbed current in cooling.	A	7,20	9,60	12,32
Max absorbed current - Cooling	A	20,79	23,99	27,19
Absorbed power - Heating	kW	4,15	5,80	7,80
Max absorbed power - Heating	kW	13,00	15,00	17,00
Absorbed current in heating	A	6,64	9,28	12,47
Max absorbed current - Heating	A	20,79	23,99	27,19
EER energy class	W/W	4,98	4,67	4,35
COP energy class	W/W	6,02	5,43	4,81
SEER energy class	W/W	5,87	5,76	5,69
SCOP energy class	W/W	6,13	6,01	5,96
Performance				
Water flow (High)	m ³ /h	4,80	6,00	7,20
Sound pressure level (High)	dB(A)	50	51	53
Sound power level (High)	dB(A)	61	62	64
Installation - Dimensions - Components				
Unit Dimensions WxDxH	mm	775x545x995		
Packaged unit dimensions WxDxH	mm	875x655x1128		
Net weight / Gross weight	Kg	172/183	172/183	172/183
Compressor type		DC Inverter Scroll	DC Inverter Scroll	DC Inverter Scroll
Quantity and type of the compressor	No.	1 INV	1 INV	1 INV
Refrigerant type		R410A	R410A	R410A
Pre-charged refrigerant qty.	Kg	2	2	2
Ø Liquid side refrigerant pipe	mm (inch)	9,52 (3/8)	9,52 (3/8)	12,7 (1/2)
Ø Gas side refrigerant pipe	mm (inch)	19,05 (3/4)	22,22 (7/8)	25,40 (1)
Ø OU Oil Equalisation Pipe	mm (inch)	9,52 (3/8)	9,52 (3/8)	9,52 (3/8)
Maximum piping length	m	300	300	300
Max linear piping length (Equivalent/Real)	m	150/120	150/120	150/120
Max height difference between IU and OU (*)	m	50/40	50/40	50/40
Water/gas exchanger				
Type		Double - tube in tube	Double - tube in tube	Double - tube in tube
Material		Copper/steel	Copper/steel	Copper/steel
Water input connection		DN32	DN32	DN32
Water output connection		DN32	DN32	DN32
Exchanger pressure drop	Kpa	35	50	70
Connection type		Internal thread	Internal thread	Internal thread
Max water input pressure	Mpa	1.6	1.6	1.6
Water input temperature range (Cooling/ Heating)	°C	7-45	7-45	7-45
Connectable Indoor Capacity Ratio				
Indoor / Outdoor Capacity Ratio	%	50-130	50-130	50-130
Maximum number of connectable IUs	No.	13	16	19

(*1) 50 m when the outdoor unit is above the indoor unit / 40 m when it is below

The specifications indicated are obtained with the following test conditions: in Cooling mode, Indoor temperature of 27°C DB / 19°C WB and Outdoor temperature of 35°C DB / 24°C WB. In Heating mode, Indoor temperature of 20°C WB and Outdoor temperature of 7°C DB / 6°C WB

Outdoor Units

MRV-W



16-24HP

AV08IMWEWA

AV10IMWEWA

AV12IMWEWA

Model		AV16IMWEWA AV08IMWEWA AV08IMWEWA	AV18IMWEWA AV08IMWEWA AV10IMWEWA	AV20IMWEWA AV10IMWEWA AV10IMWEWA	AV22IMWEWA AV10IMWEWA AV12IMWEWA	AV24IMWEWA AV12IMWEWA AV12IMWEWA
Capacity						
Power Class	HP	16	18	20	22	24
Cooling	kW	44,80	50,40	56,00	61,50	67,00
Heating	kW	50,00	56,50	63,00	69,00	75,00
Electrical Parameters						
Power supply	Ph-V/Hz	3/380-400/50/60 (5 wires L1+L2+L3+N+T)	3/380-400/50/60 (5 wires L1+L2+L3+N+T)	3/380-400/50/60 (5 wires L1+L2+L3+N+T)	3/380-400/50/60 (5 wires L1+L2+L3+N+T)	3/380-400/50/60 (5 wires L1+L2+L3+N+T)
Absorbed power - Cooling	kW	9,00	10,50	12,00	13,70	15,40
Max absorbed power - Cooling	kW	26,00	28,00	30,00	32,00	34,00
Absorbed current in cooling.	A	14,39	16,79	19,19	21,91	24,63
Max absorbed current - Cooling	A	41,58	44,78	47,98	51,18	54,38
Absorbed power - Heating	kW	8,30	9,95	11,60	13,60	15,60
Max absorbed power - Heating	kW	26,00	28,00	30,00	32,00	34,00
Absorbed current in heating	A	13,27	15,91	18,55	21,75	24,95
Max absorbed current - Heating	A	41,58	44,78	47,98	51,18	54,38
EER energy class	W/W	4,98	4,8	4,67	4,49	4,35
COP energy class	W/W	6,02	5,68	5,43	5,07	4,81
SEER energy class	W/W	5,87	5,82	5,76	5,73	5,69
SCOP energy class	W/W	6,13	6,10	6,01	5,98	5,96
Performance						
Water flow (High)	m ³ /h	9,60	10,80	12,00	13,20	14,40
Sound pressure level (High)	dB(A)	53	54	54	55	56
Sound power level (High)	dB(A)	64	65	65	66	67
Installation - Dimensions - Components						
Unit Dimensions WxDxH	mm	775x545x995+775x545x995				
Packaged unit dimensions WxDxH	mm	875x655x1128+875x655x1128				
Net weight / Gross weight	Kg	344/366	344/366	344/366	344/366	344/366
Compressor type		DC Inverter Scroll	DC Inverter Scroll	DC Inverter Scroll	DC Inverter Scroll	DC Inverter Scroll
Quantity and type of the compressor	No.	2 INV	2 INV	2 INV	2 INV	2 INV
Refrigerant type		R410A	R410A	R410A	R410A	R410A
Pre-charged refrigerant qty.	Kg	4	4	4	4	4
Ø Liquid side refrigerant pipe	mm (inch)	12,7 (1/2)	15,88 (5/8)	15,88 (5/8)	15,88 (5/8)	15,88 (5/8)
Ø Gas side refrigerant pipe	mm (inch)	28,58 (1 - 1/8)	28,58 (1 - 1/8)	28,58 (1 - 1/8)	28,58 (1 - 1/8)	28,58 (1 - 1/8)
Ø OU Oil Equalisation Pipe	mm (inch)	99,52 (3/8)	9,52 (3/8)	9,52 (3/8)	9,52 (3/8)	9,52 (3/8)
Maximum piping length	m	300	300	300	300	300
Max linear piping length (Equivalent/Real)	m	150/120	150/120	150/120	150/120	150/120
Max height difference between IU and OU (*)	m	50/40	50/40	50/40	50/40	50/40
Water/gas exchanger						
Type		Double - tube in tube	Double - tube in tube	Double - tube in tube	Double - tube in tube	Double - tube in tube
Material		Copper/steel	Copper/steel	Copper/steel	Copper/steel	Copper/steel
Water input connection		DN32	DN32	DN32	DN32	DN32
Water output connection		DN32	DN32	DN32	DN32	DN32
Exchanger pressure drop	Kpa	35+35	35+50	50+50	50+70	70+70
Connection type		Internal thread	Internal thread	Internal thread	Internal thread	Internal thread
Max water input pressure	Mpa	1,6	1,6	1,6	1,6	1,6
Water input temperature range (Cooling/Heating)	°C	7-45	7-45	7-45	7-45	7-45
Connectable Indoor Capacity Ratio						
Indoor / Outdoor Capacity Ratio	%	50-130	50-130	50-130	50-130	50-130
Maximum number of connectable IUs	No.	23	29	33	36	39

(*) 1) 50 m when the outdoor unit is above the indoor unit / 40 m when it is below

The specifications indicated are obtained with the following test conditions: in Cooling mode, Indoor temperature of 27°C DB / 19°C WB and Outdoor temperature of 35°C DB / 24°C WB. In Heating mode, Indoor temperature of 20°C WB and Outdoor temperature of 7°C DB / 6°C WB



26-30HP

AV08IMWEWA

AV10IMWEWA

Model		AV26IMWEWA AV08IMWEWA AV08IMWEWA AV10IMWEWA	AV28IMWEWA AV08IMWEWA AV10IMWEWA AV10IMWEWA	AV30IMWEWA AV10IMWEWA AV10IMWEWA AV10IMWEWA
Capacity				
Power Class	HP	26	28	30
Cooling	kW	72,80	78,40	84,00
Heating	kW	81,50	88,00	94,50
Electrical Parameters				
Power supply	Ph-V/Hz	3/380-400/50/60 (5 wires L1+L2+L3+N+T)	3/380-400/50/60 (5 wires L1+L2+L3+N+T)	3/380-400/50/60 (5 wires L1+L2+L3+N+T)
Absorbed power - Cooling	kW	15,00	16,50	18,00
Max absorbed power - Cooling	kW	41,00	43,00	45,00
Absorbed current in cooling.	A	23,99	26,39	28,79
Max absorbed current - Cooling	A	65,57	68,77	71,97
Absorbed power - Heating	kW	14,10	15,75	17,40
Max absorbed power - Heating	kW	41,00	43,00	45,00
Absorbed current in heating	A	22,55	25,19	27,83
Max absorbed current - Heating	A	65,57	68,77	71,97
EER energy class	W/W	4,85	4,75	4,67
COP energy class	W/W	5,78	5,59	5,43
SEER energy class	W/W	5,84	5,8	5,76
SCOP energy class	W/W	6,11	6,1	6,01
Performance				
Water flow (High)	m ³ /h	15,60	16,80	18,00
Sound pressure level (High)	dB(A)	55	55	56
Sound power level (High)	dB(A)	66	66	67
Installation - Dimensions - Components				
Unit Dimensions WxDxH	mm	775x545x995+775x545x995+775x545x995		
Packaged unit dimensions WxDxH	mm	875x655x1128+875x655x1128+875x655x1128		
Net weight / Gross weight	Kg	516/549	516/549	516/549
Compressor type		DC Inverter Scroll	DC Inverter Scroll	DC Inverter Scroll
Quantity and type of the compressor	No.	3 INV	3 INV	3 INV
Refrigerant type		R410A	R410A	R410A
Pre-charged refrigerant qty.	Kg	6	6	6
Ø Liquid side refrigerant pipe	mm (inch)	19,05 (3/4)	19,05 (3/4)	19,05 (3/4)
Ø Gas side refrigerant pipe	mm (inch)	31,80 (1-1/4)	31,80 (1-1/4)	31,80 (1-1/4)
Ø OU Oil Equalisation Pipe	mm (inch)	9,52 (3/8)	9,52 (3/8)	9,52 (3/8)
Maximum piping length	m	300	300	300
Max linear piping length (Equivalent/Real)	m	150/120	150/120	150/120
Max height difference between IU and OU (*)	m	50/40	50/40	50/40
Water/gas exchanger				
Type		Double - tube in tube	Double - tube in tube	Double - tube in tube
Material		Copper/steel	Copper/steel	Copper/steel
Water input connection		DN32	DN32	DN32
Water output connection		DN32	DN32	DN32
Exchanger pressure drop	Kpa	35+35+50	35+50+50	50+50+50
Connection type		Internal thread	Internal thread	Internal thread
Max water input pressure	Mpa	1,6	1,6	1,6
Water input temperature range (Cooling/ Heating)	°C	7-45	7-45	7-45
Connectable Indoor Capacity Ratio				
Indoor / Outdoor Capacity Ratio	%	50-130	50-130	50-130
Maximum number of connectable IUs	No.	43	46	50

(*1) 50 m when the outdoor unit is above the indoor unit / 40 m when it is below

The specifications indicated are obtained with the following test conditions: in Cooling mode, Indoor temperature of 27°C WB / 19°C DB and Outdoor temperature of 35°C WB / 24°C DB. In Heating mode, Indoor temperature of 20°C WB and Outdoor temperature of 7°C WB / 6°C DB

Outdoor Units

MRV-W



32-36HP

AV10IMWEWA

AV12IMWEWA

Model		AV32IMWEWA AV10IMWEWA AV10IMWEWA AV12IMWEWA	AV34IMWEWA AV10IMWEWA AV12IMWEWA AV12IMWEWA	AV36IMWEWA AV12IMWEWA AV12IMWEWA AV12IMWEWA
Capacity				
Power Class	HP	32	34	36
Cooling	kW	89.50	95.00	100.50
Heating	kW	100.50	106.50	112.50
Electrical Parameters				
Power supply	Ph-V/Hz	3/380-400/50/60 (5 wires L1+L2+L3+N+T)	3/380-400/50/60 (5 wires L1+L2+L3+N+T)	3/380-400/50/60 (5 wires L1+L2+L3+N+T)
Absorbed power - Cooling	kW	19.70	21.40	23.10
Max absorbed power - Cooling	kW	47.00	49.00	51.00
Absorbed current in cooling.	A	31.51	34.23	36.95
Max absorbed current - Cooling	A	75.17	78.37	81.57
Absorbed power – Heating	kW	19.40	21.40	23.40
Max absorbed power – Heating	kW	47.00	49.00	51.00
Absorbed current in heating	A	31.03	34.23	37.42
Max absorbed current – Heating	A	75.17	78.37	81.57
EER energy class	W/W	4.54	4.44	4.35
COP energy class	W/W	5.18	4.98	4.81
SEER energy class	W/W	5.74	5.72	5.69
SCOP energy class	W/W	5.99	5.97	5.96
Performance				
Water flow (High)	m ³ /h	19.20	20.40	21.60
Sound pressure level (High)	dB(A)	57	57	58
Sound power level (High)	dB(A)	68	68	69
Installation - Dimensions - Components				
Unit Dimensions WxDxH	mm	775x545x995+775x545x995+775x545x995		
Packaged unit dimensions WxDxH	mm	875x655x1128+875x655x1128+875x655x1128		
Net weight / Gross weight	Kg	516/549	516/549	516/549
Compressor type		DC Inverter Scroll	DC Inverter Scroll	DC Inverter Scroll
Quantity and type of the compressor	No.	3 INV	3 INV	3 INV
Refrigerant type		R410A	R410A	R410A
Pre-charged refrigerant qty.	Kg	6	6	6
Ø Liquid side refrigerant pipe	mm (inch)	19.05 (3/4)	19.05 (3/4)	19.05 (3/4)
Ø Gas side refrigerant pipe	mm (inch)	31.80 (1-1/4)	31.80 (1-1/4)	31.80 (1-1/2)
Ø OU Oil Equalisation Pipe	mm (inch)	9.52 (3/8)	9.52 (3/8)	9.52 (3/8)
Maximum piping length	m	300	300	300
Max linear piping length (Equivalent/Real)	m	150/120	150/120	150/120
Max height difference between IU and OU (*)	m	50/40	50/40	50/40
Water/gas exchanger				
Type		Double - tube in tube	Double - tube in tube	Double - tube in tube
Material		Copper/steel	Copper/steel	Copper/steel
Water input connection		DN32	DN32	DN32
Water output connection		DN32	DN32	DN32
Exchanger pressure drop	Kpa	50+50+70	50+70+70	70+70+70
Connection type		Internal thread	Internal thread	Internal thread
Max water input pressure	Mpa	1,6	1,6	1,6
Water input temperature range (Cooling/ Heating)	°C	7-45	7-45	7-45
Connectable Indoor Capacity Ratio				
Indoor / Outdoor Capacity Ratio	%	50-130	50-130	50-130
Maximum number of connectable IUs	No.	53	56	59

(*1) 50 m when the outdoor unit is above the indoor unit / 40 m when it is below

The specifications indicated are obtained with the following test conditions: in Cooling mode, Indoor temperature of 27°C WB / 19°C DB and Outdoor temperature of 35°C WB / 24°C DB. In Heating mode, Indoor temperature of 20°C WB and Outdoor temperature of 7°C WB / 6°C DB

The data in this catalogue is purely indicative as the data may vary.
Please be advised to check the accuracy of the data with the supplier before purchasing products.



MRV

Indoor Units



Round Flow Cassette

Cassette 620

Wall Mounted

1-Way Cassette

2-Way Cassette

Ceiling-Floor

Floor console, built-in

Floor Console

Slim Duct Low Pressure

Duct Low-Med Pressure

Fresh Air Duct

Duct Med Pressure

Duct High Pressure

Hydrobox



Wide range of OPTIONAL controllers.
Indoor units are NOT equipped with controller.



- AB072MRERA
- AB092MRERA
- AB122MRERA
- AB162MRERA
- AB182MRERA
- AB242MRERA
- AB282MRERA
- AB302MRERA
- AB382MRERA
- AB482MRERA
- AB602MRERA

PB-950KB(H)
(only AB122 and larger)

*Until stocks last.

<p>This controller does not allow individual vane control.</p> <div style="text-align: center;">  <p>Optional controller HW-BA101ABT</p> </div>	<div style="text-align: center;">  <p>Optional controller HW-SA201ABK</p> </div>	<div style="text-align: center;">  <p>Optional remote control YR-HQS01</p> </div>
---	--	---

R410A Units are compatible with R32 wired controllers*

- Exclusive 360° air flow system for a uniform air distribution
- Independent control of the 4 vanes
- 6 levels of positioning per individual vane
- DC inverter fan motor
- 5 fan speeds selectable with wired controller
- Standard condensate drain pump
- Ready for fresh air input (pre-cut)

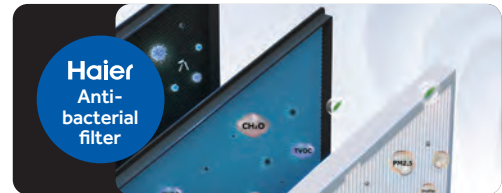

Model		AB072MRERA	AB092MRERA	AB122MRERA	AB162MRERA	AB182MRERA	AB242MRERA
Capacity							
Cooling	kW	2.20	2.80	3.60	4.50	5.60	7.10
Heating	kW	2.50	3.20	4.00	5.00	6.30	8.00
Electrical Parameters							
Power supply	Ph/V/Hz	1 / 220-240 / 50	1 / 220-240 / 50	1 / 220-240 / 50	1 / 220-240 / 50	1 / 220-240 / 50	1 / 220-240 / 50
Ventilation							
Air flow (H/M/L)	m³/h	1000/810/620	1000/810/620	1000/810/620	1000	1000	1380
Sound pressure (H/M/L)	dB(A)	30/27/25	30/27/25	30/27/25	32/29/27	33/30/29	35/34/31
Installation – Dimensions							
Net dimensions (WxDxH)	mm	840x840x180	840x840x180	840x840x180	840x840x183	840x840x183	840x840x204
Packaged unit dimensions (WxDxH)	mm	983x983x268	983x983x268	983x983x268	983x983x268	983x983x268	983x983x290
Net/gross weight	Kg	25.0/28.0	25.0/28.0	25.0/28.0	28/31	28/31	29/32
Ø Liquid pipe	mm (inch)	6.35 (1/4)	6.35 (1/4)	6.35 (1/4)	6.35 (1/4)	6.35 (1/4)	9.52 (3/8)
Ø Gas pipe	mm (inch)	9.52 (3/8)	9.52 (3/8)	12.70 (1/2)	12.70 (1/2)	12.70 (1/2)	15.88 (5/8)
Panel							
Model		PB-950KB(H)	PB-950KB(H)	PB-950KB(H)	PB-950KB(H)	PB-950KB(H)	PB-950KB(H)
Panel Net dimensions (WxDxH)	mm	950x950x50	950x950x50	950x950x50	950x950x50	950x950x50	950x950x50
Panel Packaging dimensions (WxDxH)	mm	1013x1025x123	1013x1025x123	1013x1025x123	1013x1025x123	1013x1025x123	1013x1025x123
Panel Net/gross weight	Kg	6.5/9.0	6.5/9.0	6.5/9.0	6.5/9	6.5/9	6.5/9

Model		AB282MRERA	AB302MRERA	AB382MRERA	AB482MRERA	AB602MRERA
Capacity						
Cooling	kW	8.00	9.00	11.20	14.00	16.00
Heating	kW	9.00	10.00	12.50	16.00	18.00
Electrical Parameters						
Power supply	Ph/V/Hz	1 / 220-240 / 50	1 / 220-240 / 50	1 / 220-240 / 50	1 / 220-240 / 50	1 / 220-240 / 50
Ventilation						
Air flow (H/M/L)	m³/h	1380/1190/1000	2050/1860/1670	2050/1860/1670	2100/1910/1720	2100/1910/1720
Sound pressure (H/M/L)	dB(A)	37/35/31	37/35/31	37/35/31	44/40/36	44/40/36
Installation – Dimensions						
Net dimensions (WxDxH)	mm	840x840x204	840x840x246	840x840x246	840x840x288	840x840x288
Packaged unit dimensions (WxDxH)	mm	983x983x290	983x983x331	983x983x331	983x983x373	983x983x373
Net/gross weight	Kg	27.0/30.0	31.0/36.0	31.0/36.0	33.0/38.0	33.0/38.0
Ø Liquid pipe	mm (inch)	9.52 (3/8)	9.52 (3/8)	9.52 (3/8)	9.52 (3/8)	9.52 (3/8)
Ø Gas pipe	mm (inch)	15.88 (5/8)	15.88 (5/8)	15.88 (5/8)	15.88 (5/8)	15.88 (5/8)
Panel						
Model		PB-950KB(H)	PB-950KB(H)	PB-950KB(H)	PB-950KB(H)	PB-950KB(H)
Panel Net dimensions (WxDxH)	mm	950x950x50	950x950x50	950x950x50	950x950x50	950x950x50
Panel Packaging dimensions (WxDxH)	mm	1013x1025x123	1013x1025x123	1013x1025x123	1013x1025x123	1013x1025x123
Panel Net/gross weight	Kg	6.5/9.0	6.5/9.0	6.5/9.0	6.5/9.0	6.5/9.0

AB072MNFRA
 AB092MNFRA
 AB122MNFRA
 AB162MNFRA
 AB182MNFRA
 AB242MNFRA

AB282MNFRA
 AB302MNFRA
 AB382MNFRA
 AB482MNFRA
 AB602MNFRA



Suitable for use in R410A Systems

PB-950QB(H) and PB-950QB(B)



Optional controller
HW-SA301AFK



Optional controller
HW-PB101AFK



Optional controller
YR-HQS01

- Exclusive 360° air flow system for a uniform air distribution
- Independent control of the 4 vanes
- 6 levels of positioning per individual vane
- DC inverter fan motor
- 7 fan speeds selectable with wired controller.
- Standard condensate drain pump
- Ready for fresh air input (pre-cut)
- Incorporates standard UVC ray generator to sterilize the air that flows through the unit

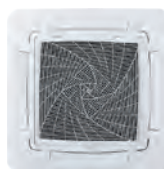

PB-950QB(H)

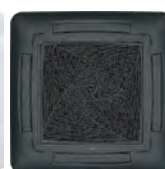

PB-950QB(B)



Model		AB072MNFRA	AB092MNFRA	AB122MNFRA	AB162MNFRA	AB182MNFRA	AB242MNFRA
Capacity							
Cooling	kW	2,2	2,8	3,6	4,5	5,6	7,1
Heating	kW	2,5	3,2	4	5	6,3	8
Electrical Parameters							
Power supply	Ph/V/Hz	1 / 220-240 / 50					
Ventilation							
Air flow (H/M/L)	m³/h	1000/750/550	1000/750/550	1000/753/585	1000/755/641	1088/909/708	1380/1100/780
Sound pressure (H/M/L)	dB(A)	30/27/23	30/27/23	33/28/25	33/30/29	34/31/27	35/34/30
Installation – Dimensions							
Net dimensions (WxDxH)	mm	840x840x180	840x840x180	840x840x180	840x840x180	840x840x180	840x840x204
Packaged unit dimensions (WxDxH)	mm	978x978x247	978x978x247	978x978x247	978x978x247	978x978x247	978x978x269
Net/gross weight	Kg	19/24	19/24	21/26	21/26	21/26	22/27
Ø Liquid pipe	mm (inch)	6,35 (1/4)	6,35 (1/4)	6,35 (1/4)	6,35 (1/4)	6,35 (1/4)	9,52 (3/8)
Ø Gas pipe	mm (inch)	9,52 (3/8)	9,52 (3/8)	12,70 (1/2)	12,70 (1/2)	12,70 (1/2)	15,88 (5/8)
Panel							
Model		PB-950QB(H) / (B)	PB-950QB(H) / (B)	PB-950QB(H) / (B)	PB-950QB(H) / (B)	PB-950QB(H) / (B)	PB-950QB(H) / (B)
Panel Net dimensions (WxDxH)	mm	950x950x50	950x950x50	950x950x50	950x950x50	950x950x50	950x950x50
Panel Packaging dimensions (WxDxH)	mm	1013x1025x123	1013x1025x123	1013x1025x123	1013x1025x123	1013x1025x123	1013x1025x123
Panel Net/gross weight	Kg	5,5/8,0	5,5/8,0	5,5/8,0	5,5/8,0	5,5/8,0	5,5/8,0



Model		AB282MNFRA	AB302MNFRA	AB382MNFRA	AB482MNFRA	AB602MNFRA
Capacity						
Cooling	kW	8	9	11,2	14	16
Heating	kW	9	10	12,5	16	18
Electrical Parameters						
Power supply	Ph/V/Hz	1 / 220-240 / 50				
Ventilation						
Air flow (H/M/L)	m³/h	1380/1150/830	1380/1180/900	2050/1500/1100	2100/1600/1170	2100/1600/1170
Sound pressure (H/M/L)	dB(A)	37/35/30	37/35/30	37/34/30	44/39/34	44/39/34
Installation – Dimensions						
Net dimensions (WxDxH)	mm	840x840x204	840x840x204	840x840x246	840x840x288	840x840x288
Packaged unit dimensions (WxDxH)	mm	978x978x269	978x978x269	978x978x312	978x978x353	978x978x353
Net/gross weight	Kg	22/27	22/27	25/31	26/32	26/32
Ø Liquid pipe	mm (inch)	9,52 (3/8)	9,52 (3/8)	9,52 (3/8)	9,52 (3/8)	9,52 (3/8)
Ø Gas pipe	mm (inch)	15,88 (5/8)	15,88 (5/8)	15,88 (5/8)	15,88 (5/8)	15,88 (5/8)
Panel						
Model		PB-950QB(H) / (B)	PB-950QB(H) / (B)	PB-950QB(H) / (B)	PB-950QB(H) / (B)	PB-950QB(H) / (B)
Panel Net dimensions (WxDxH)	mm	950x950x50	950x950x50	950x950x50	950x950x50	950x950x50
Panel Packaging dimensions (WxDxH)	mm	1013x1025x123	1013x1025x123	1013x1025x123	1013x1025x123	1013x1025x123
Panel Net/gross weight	Kg	5,5/8,0	5,5/8,0	5,5/8,0	5,5/8,0	5,5/8,0



AB052MCERA(M)
 AB072MCERA(M)
 AB092MCERA(M)
 AB122MCERA(M)
 AB162MCERA(M)
 AB182MCERA(M)

PB-620KB(H)

*Until stocks last.

This controller does not allow individual vane control.		
		
Optional controller HW-BA101ABT	Optional controller HW-SA201ABK	Optional remote control YR-HQS01

R410A Units are compatible with R32 wired controllers*

- Panel design max 620x620 dimensions
- Independent control of the 4 Vanes
- 6 positioning levels per single vane
- DC inverter fan motor
- 5 fan speeds selectable with wired controller
- Standard condensate drain pump
- Ready for fresh air input (pre-cut)



PB-620KB(H)



Model		AB052MCERA(M)	AB072MCERA(M)	AB092MCERA(M)	AB122MCERA(M)	AB162MCERA(M)	AB182MCERA(M)
Capacity							
Cooling	kW	1,50	2,20	2,80	3,60	4,50	5,60
Heating	kW	1,70	2,50	3,20	4,00	5,00	6,30
Electrical Parameters							
Power supply	Ph/V/Hz	1 / 220-240 / 50 / 60					
Ventilation							
Air flow (H/M/L)	m ³ /h	650/540/430	700/590/480	700/590/480	700/590/480	700/590/480	700/590/480
Sound pressure (H/M/L)	dB(A)	32/30/29	32/30/29	32/30/29	33/30/29	33/30/29	34/32/30
Sound power (H/M/L)	dB(A)	46/44/43	46/44/43	46/44/43	47/44/43	47/44/43	48/46/44
Installation – Dimensions							
Net dimensions (WxDxH)	mm	570x570x260	570x570x260	570x570x260	570x570x260	570x570x260	570x570x260
Packaged unit dimensions (WxDxH)	mm	718x680x380	718x680x380	718x680x380	718x680x380	718x680x380	718x680x380
Net/gross weight	Kg	16,0/19,0	16,0/19,0	16,0/19,0	19,0/22,0	19,0/22,0	19,0/22,0
Ø Liquid pipe	mm (inch)	6,35 (1/4)	6,35 (1/4)	6,35 (1/4)	6,35 (1/4)	6,35 (1/4)	6,35 (1/4)
Ø Gas pipe	mm (inch)	9,52 (3/8)	9,52 (3/8)	9,52 (3/8)	12,70 (1/2)	12,70 (1/2)	12,70 (1/2)
Panel							
Model		PB-620KB(H)	PB-620KB(H)	PB-620KB(H)	PB-620KB(H)	PB-620KB(H)	PB-620KB(H)
Panel Net dimensions (WxDxH)	mm	620x620x60	620x620x60	620x620x60	620x620x60	620x620x60	620x620x60
Panel Packaging dimensions (WxDxH)	mm	660x660x115	660x660x115	660x660x115	660x660x115	660x660x115	660x660x115
Panel Net/gross weight	Kg	3.1/4.8	3.1/4.8	3.1/4.8	3.1/4.8	3.1/4.8	3.1/4.8



AB042MCFRA
 AB052MCFRA
 AB072MCFRA
 AB092MCFRA
 AB122MCFRA
 AB162MCFRA
 AB182MCFRA
 AB242MCFRA



Suitable for use in R410A Systems

PB-620QB(H) and PB-620QB(B)



Optional controller
HW-BA316AFK



Optional controller
HW-SA301AFK



Optional controller
HW-PB101AFK



Optional controller
YR-HQS01

- Panel design max 620x620 dimensions
- Independent control of the 4 Vanes
- 6 positioning levels per single vane
- DC inverter fan motor
- 7 fan speeds selectable with wired controller
- Standard condensate drain pump
- Ready for fresh air input (pre-cut)

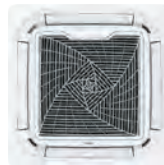

PB-620QB(H)

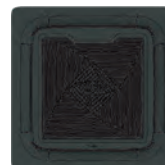

PB-620QB(B)



Model		AB042MCFRA	AB052MCFRA	AB072MCFRA	AB092MCFRA	AB122MCFRA	AB162MCFRA	AB182MCFRA	AB242MCFRA
Capacity									
Cooling	kW	1.3	1.5	2.2	2.8	3.6	4.5	5.6	7.1
Heating	kW	1.5	1.8	2.5	3.2	4	5	6.3	8
Electrical Parameters									
Power supply	Ph/V/Hz	1 / 220-240 / 50							
Ventilation									
Air flow (H/M/L)	m³/h	530/380/270	530/380/270	530/380/270	590/430/270	640/480/330	740/590/380	850/690/480	910/800/650
Sound pressure (H/M/L)	dB(A)	30/28/24	30/28/24	30/28/24	31/29/24	34/28/24	37/32/25	42/36/31	43/41/32
Installation – Dimensions									
Net dimensions (WxDxH)	mm	575x575x260	575x575x260	575x575x260	575x575x260	575x575x260	575x575x260	575x575x260	575x575x260
Packaged unit dimensions (WxDxH)	mm	713x659x375	713x659x375	713x659x375	713x659x375	713x659x375	713x659x375	713x659x375	713x659x375
Net/gross weight	Kg	13,5/14,8	13,5/14,8	13,5/14,8	13,5/14,8	13,5/14,8	14,9/16,2	14,9/16,2	15,5/16,8
Ø Liquid pipe	mm (inch)	6,35 (1/4)	6,35 (1/4)	6,35 (1/4)	6,35 (1/4)	6,35 (1/4)	6,35 (1/4)	6,35 (1/4)	9,52 (3/8)
Ø Gas pipe	mm (inch)	9,52 (3/8)	9,52 (3/8)	9,52 (3/8)	9,52 (3/8)	12,70 (1/2)	12,70 (1/2)	12,70 (1/2)	15,88 (5/8)
Panel									
Model		PB-620QB(H)/ PB-620QB(B)	PB-620QB(H)/ PB-620QB(B)	PB-620QB(H)/ PB-620QB(B)	PB-620QB(H)/ PB-620QB(B)	PB-620QB(H)/ PB-620QB(B)	PB-620QB(H)/ PB-620QB(B)	PB-620QB(H)/ PB-620QB(B)	PB-620QB(H)/ PB-620QB(B)
Panel Net dimensions (WxDxH)	mm	620x620x60	620x620x60	620x620x60	620x620x60	620x620x60	620x620x60	620x620x60	620x620x60
Panel Packaging dimensions (WxDxH)	mm	666x681x108	666x681x108	666x681x108	666x681x108	666x681x108	666x681x108	666x681x108	666x681x108
Panel Net/gross weight	Kg	2,2 / 3,7	2,2 / 3,7	2,2 / 3,7	2,2 / 3,7	2,2 / 3,7	2,2 / 3,7	2,2 / 3,7	2,2 / 3,7



AS052MNERAB
AS072MNERAB
AS092MNERAB
AS122MNERAB
AS162MNERA
AS182MNERA
AS242MNERA
AS282MNERA
AS302MNERA

AS**2MNERAC
External EEV



*Until stocks last.



Optional controller
HW-BA101ABT



Optional controller
HW-SA201ABK



Controller
YR-HQS01

R410A Units are compatible with R32 wired controllers*

- Compact, linear design with dimmable information display
- DC inverter fan motor
- External EEV (Optional)
- 5 fan speeds selectable with wired controller



The external EEV modulation valve must be installed in the liquid pipe, between 2m and 5m from the unit. This allows to move this sound source out of the room, reaching high levels of silence for the perfect comfort in hotels, commerces or offices.

Model	AS052MNERAB		AS072MNERAB		AS092MNERAB		AS122MNERAB	
	AS052MNERAC		AS072MNERAC		AS092MNERAC		AS122MNERAC	
Capacity								
Cooling	kW	1,50	2,20	2,80	3,60			
Heating	kW	1,70	2,50	3,20	4,00			
Electrical Parameters								
Power supply	Ph/V/Hz	1/220-240/50/60						
Ventilation								
Air flow (H/M/L)	m³/h	500/430/370	550/480/420	600/530/470	630/560/500			
Sound pressure (H/M/L)	dB(A)	33/31/29	35/31/29	36/31/29	37/33/29			
Sound power (H/M/L)	dB(A)	49/46/41	50/47/42	52/48/44	54/51/50			
Installation – Dimensions								
Net dimensions (WxDxH)	mm	855x208x280	855x208x280	855x208x280	855x208x280			
Packaged unit dimensions (WxDxH)	mm	954x279x355	954x279x355	954x279x355	954x279x355			
Net/gross weight	Kg	9,9/12,0	9,9/12,0	9,9/12,0	9,9/12,0			
Ø Liquid pipe	mm (inch)	6,35 (1/4)	6,35 (1/4)	6,35 (1/4)	6,35 (1/4)			
Ø Gas pipe	mm (inch)	9,52 (3/8)	9,52 (3/8)	9,52 (3/8)	12,70 (1/2)			

Model	AS162MNERA		AS182MNERA		AS242MNERA		AS282MNERA		AS302MNERA	
	AS162MNERAC		AS182MNERAC		AS242MNERAC		AS282MNERAC		AS302MNERAC	
Capacity										
Cooling	kW	4,50	5,60	7,10	8,00	9,00				
Heating	kW	5,00	6,30	8,00	9,00	10,00				
Electrical Parameters										
Power supply	Ph/V/Hz	1/220-240/50/60								
Ventilation										
Air flow (H/M/L)	m³/h	800/720/650	920/800/720	1010/920/800	1500/1400/1300	1600/1500/1400				
Sound pressure (H/M/L)	dB(A)	39/36/34	40/39/35	44/40/36	48/43/40	49/44/41				
Sound power (H/M/L)	dB(A)	56/53/51	57/54/52	58/56/54	60/57/53	61/58/54				
Installation – Dimensions										
Net dimensions (WxDxH)	mm	1115x243x336	1115x243x336	1115x243x336	1316x270x365	1316x270x365				
Packaged unit dimensions (WxDxH)	mm	1206x342x418	1206x342x418	1206x342x418	1403x384x463	1403x384x463				
Net/gross weight	Kg	15,8/18,9	15,8/18,9	15,8/18,9	21,8/26,3	21,8/26,3				
Ø Liquid pipe	mm (inch)	6,35 (1/4)	6,35 (1/4)	9,52 (3/8)	9,52 (3/8)	9,52 (3/8)				
Ø Gas pipe	mm (inch)	12,70 (1/2)	12,70 (1/2)	15,88 (5/8)	15,88 (5/8)	15,88 (5/8)				

AS042MFFRA
AS052MFFRA
AS072MFFRA
AS092MFFRA
AS122MFFRA
AS162MFFRA
AS182MFFRA
AS242MFFRA

AS**2MFFRAC
External EEV



AS282MNFRA
AS302MNFRA



Suitable for use in R410A Systems



Optional controller
HW-BA316AFK



Optional controller
HW-SA301AFK



Optional controller
HW-PB101AFK



Controller
YR-HQS01

- Compact, Stylish design & LED display
- DC inverter fan motor
- External EEV (Optional)
- 7 fan speeds selectable with wired controller



The external EEV modulation valve must be installed in the liquid pipe, between 2m and 5m from the unit. This allows to move this sound source out of the room, reaching high levels of silence for the perfect confort in hotels, commerces or offices.

Model	AS042MFFRA		AS052MFFRA		AS072MFFRA		AS092MFFRA		AS122MFFRA	
	AS042MFFRAC		AS052MFFRAC		AS072MFFRAC		AS092MFFRAC		AS122MFFRAC	
Capacity										
Cooling	kW	1.1	1.5	2.2	2.8	3.6				
Heating	kW	1.3	1.7	2.5	3.2	4				
Electrical Parameters										
Power supply	Ph/V/Hz	1 / 220-240 / 50								
Ventilation										
Air flow (H/M/L)	m³/h	450/375/305	480/400/305	550/420/309	600/455/309	630/565/309				
Sound pressure (H/M/L)	dB(A)	34/31/28	35/33/28	36/34/28	38/34/28	39/37/28				
Sound power (H/M/L)	dB(A)	51/48/45	52/50/45	53/51/45	55/51/45	56/54/45				
Installation – Dimensions										
Net dimensions (WxDxH)	mm	855x208x280	855x208x280	855x208x280	855x208x280	855x208x280				
Packaged unit dimensions (WxDxH)	mm	954x279x355	954x279x355	954x279x355	954x279x355	954x279x355				
Net/gross weight	Kg	9,9/12	9,9/12	9,9/12	9,9/12	9,9/12				
Ø Liquid pipe	mm (inch)	6.35 (1/4)	6.35 (1/4)	6.35 (1/4)	6.35 (1/4)	6.35 (1/4)				
Ø Gas pipe	mm (inch)	9.52 (3/8)	9.52 (3/8)	9.52 (3/8)	9.52 (3/8)	12.70 (1/2)				

Model	AS162MFFRA		AS182MFFRA		AS242MFFRA		AS282MNFRA		AS302MNFRA	
	AS162MFFRAC		AS182MFFRAC		-		-		-	
Capacity										
Cooling	kW	4,5	5,6	7,1	8	9				
Heating	kW	5	6,3	8	9	10				
Electrical Parameters										
Power supply	Ph/V/Hz	1 / 220-240 / 50								
Ventilation										
Air flow (H/M/L)	m³/h	800/740/620	920/755/650	1010/900/650	1500/1440/1300	1600/1460/1350				
Sound pressure (H/M/L)	dB(A)	39/36/33	40/37/34	44/41/35	48/43/40	49/44/41				
Sound power (H/M/L)	dB(A)	56/53/50	57/54/51	61/58/52	65/60/57	66/61/58				
Installation – Dimensions										
Net dimensions (WxDxH)	mm	1115x243x336	1115x243x336	1115x243x336	1316x270x365	1316x270x365				
Packaged unit dimensions (WxDxH)	mm	1206x342x418	1206x342x418	1206x342x418	1403x384x463	1403x384x463				
Net/gross weight	Kg	15,8/18,9	15,8/18,9	15,8/18,9	21,8/26,3	21,8/26,3				
Ø Liquid pipe	mm (inch)	6.35 (1/4)	6.35 (1/4)	9.52 (3/8)	9.52 (3/8)	9.52 (3/8)				
Ø Gas pipe	mm (inch)	12.70 (1/2)	12.70 (1/2)	15.88 (5/8)	15.88 (5/8)	15.88 (5/8)				



AB052MAERAD
AB072MAERAD
AB092MAERAD
AB122MAERAD
AB162MAERAD
AB182MAERAD
AB242MAERAD

*Until stocks last.

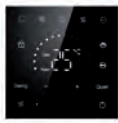

Optional controller
HW-BA101ABT



Optional controller
HW-SA201ABK



Optional remote control
YR-HQS01

R410A Units are compatible with R32 wired controllers*

- Modern, thin and linear design panel
- Automatic opening and closing of air discharge and air intake louvres
- 3D ventilation
- DC inverter fan motor
- 5 fan speeds selectable with wired controller
- Quiet and ultra thin design (185mm)
- Standard intake filter
- Standard condensate drain pump

Model		AB052MAERAD	AB072MAERAD	AB092MAERAD	AB122MAERAD	AB162MAERAD	AB182MAERAD	AB242MAERAD
Capacity								
Cooling	kW	1.5	2.2	2.8	3.6	4.5	5.6	7.1
Heating	kW	1.7	2.5	3.2	4	5	6.3	8
Electrical Parameters								
Power supply	Ph/V/Hz	1 / 220-240 / 50						
Ventilation								
Air flow (High)	m ³ /h	540/400/270	540/400/270	540/400/270	650/510/390	700/530/410	820/660/510	870/690/510
Sound pressure (H/M/L)	dB(A)	38/33/28	38/33/28	38/33/28	40/36/31	41/36/32	40/36/32	42/36/32
Sound power (H/M/L)	dB(A)	52/47/42	52/47/42	52/47/42	54/50/45	55/50/46	54/50/46	56/50/46
Installation – Dimensions								
Net dimensions (WxDxH)	mm	850x540x185	850x540x185	850x540x185	850x540x185	850x540x185	1170x540x185	1170x540x185
Packaged unit dimensions (WxDxH)	mm	1043x648x270	1043x648x270	1043x648x270	1043x648x270	1043x648x270	1363x648x270	1363x648x270
Net/gross weight	Kg	20.5/24.7	20.5/24.7	20.5/24.7	20.8/24.9	21.3/25.5	26.0/31.4	27.1/32.5
Ø Liquid pipe	mm (inch)	6.35 (1/4)	6.35 (1/4)	6.35 (1/4)	6.35 (1/4)	6.35 (1/4)	6.35 (1/4)	9.52 (3/8)
Ø Gas pipe	mm (inch)	9.52 (3/8)	9.52 (3/8)	9.52 (3/8)	12.7 (1/2)	12.7 (1/2)	12.7 (1/2)	15.88 (5/8)
Panel								
Model		P1B-1028IB	P1B-1028IB	P1B-1028IB	P1B-1028IB	P1B-1028IB	P1B-1028IB	P1B-1028IB
Panel Net dimensions (WxDxH)	mm	1028x600x45	1028x600x45	1028x600x45	1028x600x45	1028x600x45	1348x600x45	1348x600x45
Panel Packaging dimensions (WxDxH)	mm	1143x688x170	1143x688x170	1143x688x170	1143x688x170	1143x688x170	1463x688x170	1463x688x170
Panel Net/gross weight	Kg	3.9/8.0	3.9/8.0	3.9/8.0	3.9/8.0	3.9/8.0	5.1/9.8	5.1/9.8



AB052MAFRA
 AB072MAFRA
 AB092MAFRA
 AB122MAFRA
 AB162MAFRA
 AB182MAFRA
 AB242MAFRA



Suitable for use in R410A Systems



Optional controller
HW-BA316AFK



Optional controller
HW-SA301AFK



Optional controller
HW-PB101AFK



Optional controller
YR-HQS01

- Modern, thin and linear design panel
- Automatic opening and closing of air discharge and air intake louvers
- 3D ventilation
- DC inverter fan motor
- 7 fan speeds selectable with wired controller
- Quiet and ultra thin design (185mm)
- Standard intake filter
- Standard condensate drain pump

Model		AB052MAFRA	AB072MAFRA	AB092MAFRA	AB122MAFRA	AB162MAFRA	AB182MAFRA	AB242MAFRA
Capacity								
Cooling	kW	1.5	2.2	2.8	3.6	4.5	5.6	7.1
Heating	kW	1.7	2.5	3.2	4.0	5.0	6.3	8.0
Electrical Parameters								
Power supply	Ph/V/Hz	1 / 220-240 / 50						
Ventilation								
Air flow (High)	m ³ /h	540/400/270	589/470/330	665/540/400	700/575/450	730/630/495	820/660/510	870/690/510
Sound pressure (H/M/L)	dB(A)	36/32/28	38/34/30	39/36/32	40/37/33	40/38/34	40/36/32	42/36/32
Sound power (H/M/L)	dB(A)	50/46/42	52/48/44	53/50/46	54/51/47	54/52/48	54/50/46	56/50/46
Installation – Dimensions								
Net dimensions (WxDxH)	mm	850x540x185	850x540x185	850x540x185	850x540x185	850x540x185	1170x540x185	1170x540x185
Packaged unit dimensions (WxDxH)	mm	1043x648x270	1043x648x270	1043x648x270	1043x648x270	1043x648x270	1363x648x270	1363x648x270
Net/gross weight	Kg	20.5/24.7	20.5/24.7	20.5/24.7	20.8/24.9	21.3/25.5	26.0/31.4	27.1/32.5
Ø Liquid pipe	mm (inch)	6.35 (1/4)	6.35 (1/4)	6.35 (1/4)	6.35 (1/4)	6.35 (1/4)	6.35 (1/4)	9.52 (3/8)
Ø Gas pipe	mm (inch)	9.52 (3/8)	9.52 (3/8)	9.52 (3/8)	12.7 (1/2)	12.7 (1/2)	12.7 (1/2)	15.88 (5/8)
Panel								
Model		P1B-1028IC	P1B-1028IC	P1B-1028IC	P1B-1028IC	P1B-1028IC	P1B-1028IC	P1B-1028IC
Panel Net dimensions (WxDxH)	mm	1028x600x45	1028x600x45	1028x600x45	1028x600x45	1028x600x45	1348x600x45	1348x600x45
Panel Packaging dimensions (WxDxH)	mm	1143x688x170	1143x688x170	1143x688x170	1143x688x170	1143x688x170	1463x688x170	1463x688x170
Panel Net/gross weight	Kg	3.9/8	3.9/8	3.9/8	3.9/8	3.9/8	5.1/9.8	5.1/9.8



AB072MBERAD
 AB092MBFRAD
 AB122MBERAD
 AB162MBERAD
 AB182MBERAD
 AB242MBERAD
 AB282MBERAD
 AB302MBERAD
 AB382MBERAD
 AB482MBERAD

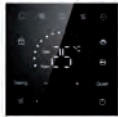

Optional controller
 HW-BA101ABT



Optional controller
 HW-SA201ABK



Optional remote control
 YR-HQS01

R410A Units are compatible with R32 wired controllers*

- Standard condensate drain pump
- Silent operation
- DC inverter fan motor
- Ceiling anti-fouling design

Model		AB072MBERAD	AB092MBERAD	AB122MBERAD	AB162MBERAD	AB182MBERAD
Capacity						
Cooling	kW	2,2	2,8	3,6	4,5	5,6
Heating	kW	2,5	3,2	4	5	6,3
Electrical Parameters						
Power supply	Ph/V/Hz	1 / 220-240 / 50				
Ventilation						
Air flow (H/M/L)	m ³ /h	650/550/390	700/600/410	730/600/430	800/650/450	950/780/500
Sound pressure (H/M/L)	dB(A)	32/30/28	34/31/29	35/32/30	37/34/32	39/37/34
Sound power (H/M/L)	dB(A)	48/46/44	50/47/45	51/48/46	53/50/48	55/53/50
Installation – Dimensions						
Net dimensions (WxDxH)	mm	1000x600x290	1000x600x290	1000x600x290	1000x600x290	1000x600x290
Packaged unit dimensions (WxDxH)	mm	1201x680x377	1201x680x377	1201x680x377	1201x680x377	1201x680x377
Net/gross weight	Kg	33/40	33/40	33/40	34/41	34/41
Ø Liquid pipe	mm (inch)	6,35 (1/4)	6,35 (1/4)	6,35 (1/4)	6,35 (1/4)	6,35 (1/4)
Ø Gas pipe	mm (inch)	9,52 (3/8)	9,52 (3/8)	12,7 (1/2)	12,7 (1/2)	12,7 (1/2)
Panel						
Model		P2B-1160IB	P2B-1160IB	P2B-1160IB	P2B-1160IB	P2B-1160IB
Panel Net dimensions (WxDxH)	mm	1160x665x60	1160x665x60	1160x665x60	1160x665x60	1160x665x60
Panel Packaging dimensions (WxDxH)	mm	1244x748x159	1244x748x159	1244x748x159	1244x748x159	1244x748x159
Panel Net/gross weight	Kg	6,3/12	6,3/12	6,3/12	6,3/12	6,3/12

Model		AB242MBERAD	AB282MBERAD	AB302MBERAD	AB382MBERAD	AB482MBERAD
Capacity						
Cooling	kW	7,1	8	9	11,2	14
Heating	kW	8	9	10	12,5	16
Electrical Parameters						
Power supply	Ph/V/Hz	1 / 220-240 / 50				
Ventilation						
Air flow (H/M/L)	m ³ /h	1000/850/700	1100/950/800	1500/1350/1110	1700/1450/1200	1950/1750/1350
Sound pressure (H/M/L)	dB(A)	40/38/35	41/39/36	42/39/36	44/40/36	46/42/38
Sound power (H/M/L)	dB(A)	56/54/51	57/55/52	58/55/52	60/56/52	62/58/54
Installation – Dimensions						
Net dimensions (WxDxH)	mm	1000x600x290	1400x600x290	1400x600x290	1400x600x290	1400x600x290
Packaged unit dimensions (WxDxH)	mm	1201x680x377	1601x680x377	1601x680x377	1601x680x377	1601x680x377
Net/gross weight	Kg	34/41	45/54	45/54	45/54	45/54
Ø Liquid pipe	mm (inch)	9,52 (3/8)	9,52 (3/8)	9,52 (3/8)	9,52 (3/8)	9,52 (3/8)
Ø Gas pipe	mm (inch)	15,88 (5/8)	15,88 (5/8)	15,88 (5/8)	15,88 (5/8)	15,88 (5/8)
Panel						
Model		P2B-1160IB	P2B-1560IB	P2B-1560IB	P2B-1560IB	P2B-1560IB
Panel Net dimensions (WxDxH)	mm	1160x665x60	1560x665x60	1560x665x60	1560x665x60	1560x665x60
Panel Packaging dimensions (WxDxH)	mm	1244x748x159	1644x748x159	1644x748x159	1644x748x159	1644x748x159
Panel Net/gross weight	Kg	6,3/12	8/14,5	8/14,5	8/14,5	8/14,5



AB072MBFRA
 AB092MBFRA
 AB122MBFRA
 AB162MBFRA
 AB182MBFRA
 AB242MBFRA
 AB282MBFRA
 AB302MBFRA
 AB382MBFRA
 AB482MBFRA



Suitable for use in R410A Systems



Optional controller
HW-BA316AFK



Optional controller
HW-SA301AFK



Optional controller
HW-PB101AFK



Optional controller
YR-HQS01

- Standard condensate drain pump
- Silent operation
- DC inverter fan motor
- Ceiling anti-fouling design

Model		AB072MBFRA	AB092MBFRA	AB122MBFRA	AB162MBFRA	AB182MBFRA
Capacity						
Cooling	kW	2,2	2,8	3,6	4,5	5,6
Heating	kW	2,5	3,2	4	5	6,3
Electrical Parameters						
Power supply	Ph/V/Hz	1 / 220-240 / 50				
Ventilation						
Air flow (H/M/L)	m ³ /h	620/560/445	665/600/470	700/600/490	750/650/515	900/790/600
Sound pressure (H/M/L)	dB(A)	31/31/29	32/31/29	34/31/30	36/35/33	39/37/34
Sound power (H/M/L)	dB(A)	47/47/45	48/47/45	50/47/46	52/51/49	55/53/50
Installation – Dimensions						
Net dimensions (WxDxH)	mm	1000x600x290	1000x600x290	1000x600x290	1000x600x290	1000x600x290
Packaged unit dimensions (WxDxH)	mm	1201x680x377	1201x680x377	1201x680x377	1201x680x377	1201x680x377
Net/gross weight	Kg	33/40	33/40	33/40	34/41	34/41
Ø Liquid pipe	mm (inch)	6,35 (1/4)	6,35 (1/4)	6,35 (1/4)	6,35 (1/4)	6,35 (1/4)
Ø Gas pipe	mm (inch)	9,52 (3/8)	9,52 (3/8)	12,7 (1/2)	12,7 (1/2)	12,7 (1/2)
Panel						
Model		P2B-1160IB	P2B-1160IB	P2B-1160IB	P2B-1160IB	P2B-1160IB
Panel Net dimensions (WxDxH)	mm	1160x665x60	1160x665x60	1160x665x60	1160x665x60	1160x665x60
Panel Packaging dimensions (WxDxH)	mm	1244x748x159	1244x748x159	1244x748x159	1244x748x159	1244x748x159
Panel Net/gross weight	Kg	6,3/12	6,3/12	6,3/12	6,3/12	6,3/12

Model		AB242MBFRA	AB282MBFRA	AB302MBFRA	AB382MBFRA	AB482MBFRA
Capacity						
Cooling	kW	7,1	8	9	11,2	14
Heating	kW	8	9	10	12,5	16
Electrical Parameters						
Power supply	Ph/V/Hz	1 / 220-240 / 50				
Ventilation						
Air flow (H/M/L)	m ³ /h	950/850/750	1040/925/825	1465/1350/1210	1640/1450/1280	1855/1750/1540
Sound pressure (H/M/L)	dB(A)	40/38/36	39/37/36	42/41/40	43/42/40	45/44/42
Sound power (H/M/L)	dB(A)	56/54/52	55/53/52	58/57/56	59/58/56	61/60/58
Installation – Dimensions						
Net dimensions (WxDxH)	mm	1000x600x290	1400x600x290	1400x600x290	1400x600x290	1400x600x290
Packaged unit dimensions (WxDxH)	mm	1201x680x377	1601x680x377	1601x680x377	1601x680x377	1601x680x377
Net/gross weight	Kg	34/41	45/54	45/54	45/54	45/54
Ø Liquid pipe	mm (inch)	9,52 (3/8)	9,52 (3/8)	9,52 (3/8)	9,52 (3/8)	9,52 (3/8)
Ø Gas pipe	mm (inch)	15,88 (5/8)	15,88 (5/8)	15,88 (5/8)	15,88 (5/8)	15,88 (5/8)
Panel						
Model		P2B-1160IB	P2B-1560IB	P2B-1560IB	P2B-1560IB	P2B-1560IB
Panel Net dimensions (WxDxH)	mm	1160x665x60	1560x665x60	1560x665x60	1560x665x60	1560x665x60
Panel Packaging dimensions (WxDxH)	mm	1244x748x159	1644x748x159	1644x748x159	1644x748x159	1644x748x159
Panel Net/gross weight	Kg	6,3/12	8/14,5	8/14,5	8/14,5	8/14,5

The data in this catalogue is purely indicative as the data may vary. Please be advised to check the accuracy of the data with the supplier before purchasing products.



AC092MDERA
AC122MDERA
AC162MDERA
AC182MDERA
AC242MDERA
AC282MDERA
AC302MDERA
AC382MDERA
AC482MDERA

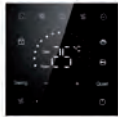

Optional controller
HW-BA101ABT



Optional controller
HW-SA201ABK



Optional remote control
YR-HQS01

R410A Units are compatible with R32 wired controllers*



- Subtle and harmonious design
- 5 fan speeds selectable with wired controller
- 3D ventilation with independent right and left wing group
- Flexible installation - Floor and ceiling position
- DC inverter fan motor
- Ready for fresh air input

Model		AC092MDERA	AC122MDERA	AC162MDERA	AC182MDERA
Capacity					
Cooling	kW	2,80	3,60	4,50	5,60
Heating	kW	3,20	4,00	5,00	6,30
Electrical Parameters					
Power supply	Ph/V/Hz	1 / 220-240 / 50			
Ventilation					
Air flow (H/M/L)	m ³ /h	820/750/690	820/750/690	950/820/690	950/820/690
Sound pressure (H/M/L)	dB(A)	38/36/34	38/36/34	42/38/35	42/38/35
Sound power (H/M/L)	dB(A)	52/50/47	52/50/47	55/51/48	55/51/48
Installation - Dimensions					
Net dimensions (WxDxH)	mm	1000x230x680			
Packaged unit dimensions (WxDxH)	mm	1100x305x779			
Net/gross weight	Kg	27.9/33,6	27.9/33,6	27.9/33,6	27.9/33,6
Ø Liquid pipe	mm (inch)	6.35 (1/4)	6.35 (1/4)	6.35 (1/4)	6.35 (1/4)
Ø Gas pipe	mm (inch)	9.52 (3/8)	12.70 (1/2)	12.70 (1/2)	12.70 (1/2)

Model		AC242MDERA	AC282MDERA	AC302MDERA	AC382MDERA	AC482MDERA
Capacity						
Cooling	kW	7,10	8,00	9,00	11,20	14,00
Heating	kW	8,00	9,00	10,00	12,50	16,00
Electrical Parameters						
Power supply	Ph/V/Hz	1 / 220-240 / 50				
Ventilation						
Air flow (H/M/L)	m ³ /h	1420/1270/1240	1570/1420/1240	1570/1420/1240	2110/1990/1750	2110/1990/1750
Sound pressure (H/M/L)	dB(A)	46/44/41	47/44/41	47/44/41	50/46/43	50/46/43
Sound power (H/M/L)	dB(A)	60/58/54	61/58/54	61/58/55	63/60/57	63/60/57
Installation - Dimensions						
Net dimensions (WxDxH)	mm	1325x230x680			1650x230x680	
Packaged unit dimensions (WxDxH)	mm	1425x305x779			1750x305x779	
Net/gross weight	Kg	35.8/42.1	35.8/42.1	35.8/42.1	43.5/50.5	43.5/50.5
Ø Liquid pipe	mm (inch)	9.52 (3/8)	9.52 (3/8)	9.52 (3/8)	9.52 (3/8)	9.52 (3/8)
Ø Gas pipe	mm (inch)	15.88 (5/8)	15,88 (5/8)	15,88 (5/8)	15,88 (5/8)	15,88 (5/8)



AE072MLERA
 AE092MLERA
 AE122MLERA
 AE162MLERA
 AE182MLERA
 AE242MLERA

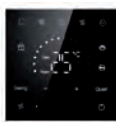

Optional controller
 HW-BA101ABT



Optional controller
 HW-SA201ABK



Optional remote control
 YR-HQS01

R410A Units are compatible with R32 wired controllers*

- Compact and thin, only 220 mm depth
- Ideal for installation under window
- High-efficiency standard filter

Model		AE072MLERA	AE092MLERA	AE122MLERA	AE162MLERA	AE182MLERA	AE242MLERA
Capacity							
Cooling	kW	2.20	2.80	3.60	4.50	5.60	7.10
Heating	kW	2.50	3.20	4.00	5.00	6.30	8.00
Electrical Parameters							
Power supply	Ph/V/Hz	1 / 220-240 / 50					
Ventilation							
Air flow (H/M/L)	m ³ /h	750/650/550	750/650/550	750/650/550	950/830/720	950/830/720	950/830/720
Sound pressure (H/M/L)	dB(A)	38/35/33	38/35/33	40/37/35	40/37/35	42/39/36	42/39/36
Sound power level (H/M/L)	dB(A)	51/48/46	51/48/46	53/50/48	53/50/48	55/52/49	55/52/49
Installation – Dimensions							
Net dimensions (WxDxH)	mm	1116x221x624	1116x221x624	1116x221x624	1116x221x624	1116x221x624	1116x221x624
Packaged unit dimensions WxDxH	mm	1425x315x685	1425x315x685	1425x315x685	1425x315x685	1425x315x685	1425x315x685
Net weight / Gross weight	Kg	29,0/37,0	29,0/37,0	29,0/37,0	31,0/39,0	31,0/39,0	31,0/39,0
Ø Liquid pipe	mm (inch)	6,35 (1/4)	6,35 (1/4)	6,35 (1/4)	6,35 (1/4)	6,35 (1/4)	9,52 (3/8)
Ø Gas pipe	mm (inch)	9,52 (3/8)	9,52 (3/8)	12,70 (1/2)	12,70 (1/2)	12,70 (1/2)	15,88 (5/8)
Static pressure (Standard/Max.)	Pa	0/30	0/30	0/30	0/30	0/30	0/30



AF052MBERA
AF072MBERA
AF092MBERA
AF122MBERA
AF162MBERA
AF182MBERA

*Until stocks last.



Optional controller
HW-BA101ABT



Optional controller
HW-SA201ABK



Optional remote control
YR-HQS01

R410A Units are compatible with R32 wired controllers*

- Double air delivery, upper and lower.
In heating mode: both outputs are enabled, to spread hot air at floor level preventing the "cold feet" effect typical of only higher deliveries. By acting on the on-board selector it is possible to inhibit the lower output in heating mode.
In cooling mode: The unit works only with the top delivery, the lower output automatically closes.
- Compact and elegant design
- Silent operation
- DC inverter fan motor
- 5 fan speeds selectable with wired controller

Model		AF052MBERA	AF072MBERA	AF092MBERA	AF122MBERA	AF162MBERA	AF182MBERA
Capacity							
Cooling	kW	1,50	2,20	2,80	3,60	4,50	5,00
Heating	kW	1,70	2,60	3,20	4,00	5,00	5,50
Electrical Parameters							
Power supply	Ph/V/Hz	1 / 220-240 / 50					
Ventilation							
Air flow (H/M/L)	m ³ /h	540/390/270	540/390/270	540/390/270	580/420/270	620/460/270	620/460/270
Sound pressure (H/M/L)	dB(A)	45/38/30	45/38/30	45/38/30	47/40/30	48/42/30	48/42/30
Sound power (H/M/L)	dB(A)	58/52/45	58/52/45	58/52/45	60/54/47	61/55/48	61/55/48
Installation – Dimensions							
Net dimensions (WxDxH)	mm	700x210x600	700x210x600	700x210x600	700x210x600	700x210x600	700x210x600
Packaged unit dimensions (WxDxH)	mm	783x303x695	783x303x695	783x303x695	783x303x695	783x303x695	783x303x695
Net/gross weight	Kg	15,2/18,7	15,2/18,7	15,2/18,7	15,2/18,7	15,2/18,7	15,2/18,7
Ø Liquid pipe	mm (inch)	6,35 (1/4)	6,35 (1/4)	6,35 (1/4)	6,35 (1/4)	6,35 (1/4)	6,35 (1/4)
Ø Gas pipe	mm (inch)	12,70 (1/2)	12,70 (1/2)	12,70 (1/2)	12,70 (1/2)	12,70 (1/2)	12,70 (1/2)



Suitable for use in R410A Systems

AF052MBFRA
AF072MBFRA
AF092MBFRA
AF122MBFRA
AF162MBFRA
AF182MBFRA



Optional controller
HW-BA316AFK



Optional controller
HW-SA301AFK



Optional controller
HW-PB101AFK



Optional controller
YR-HQS01

- Double air delivery, upper and lower.
In heating mode: both outputs are enabled, to spread hot air at floor level preventing the "cold feet" effect typical of only higher deliveries. By acting on the on-board selector it is possible to inhibit the lower output in heating mode.
In cooling mode: The unit works only with the top delivery, the lower output automatically closes.
- Compact and elegant design
- Silent operation
- DC inverter fan motor
- 7 fan speeds selectable with wired controller

Model		AF052MBFRA	AF072MBFRA	AF092MBFRA	AF122MBFRA	AF162MBFRA	AF182MBFRA
Capacity							
Cooling	kW	1.5	2.2	2.8	3.6	4.5	5
Heating	kW	1.7	2.6	3.2	4	5	5.5
Electrical Parameters							
Power supply	Ph/V/Hz	1 / 220-240 / 50					
Ventilation							
Air flow (H/M/L)	m ³ /h	390/325/295	420/345/310	460/390/325	500/420/345	500/420/390	580/500/420
Sound pressure (H/M/L)	dB(A)	38/36/32	40/37/34	42/38/36	43/40/37	45/42/38	47/43/40
Sound power (H/M/L)	dB(A)	52/50/46	54/51/48	56/52/50	57/54/51	59/56/52	61/57/54
Installation – Dimensions							
Net dimensions (WxDxH)	mm	700x210x600	700x210x600	700x210x600	700x210x600	700x210x600	700x210x600
Packaged unit dimensions (WxDxH)	mm	783x303x695	783x303x695	783x303x695	783x303x695	783x303x695	783x303x695
Net/gross weight	Kg	15,2 / 18,7	15,2 / 18,7	15,2 / 18,7	15,2 / 18,7	15,2 / 18,7	15,2 / 18,7
Ø Liquid pipe	mm (inch)	6,35 (1/4)	6,35 (1/4)	6,35 (1/4)	6,35 (1/4)	6,35 (1/4)	6,35 (1/4)
Ø Gas pipe	mm (inch)	12,70 (1/2)	12,70 (1/2)	12,70 (1/2)	12,70 (1/2)	12,70 (1/2)	12,70 (1/2)

MRV SLIM DUCTED HEALTH FEATURES

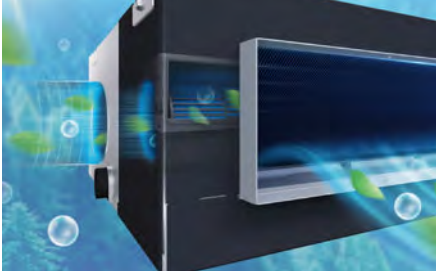

Healthier air flow

Mold and bacteria are unable to grow on the components where air flows through, with help from silver ions, which bring no harm to human health. This process means the unit always produces clean and healthy air.



UVC sterilisation

The built-in UVC sterilisation function emits UV light to sterilise the air passing through with an efficiency of 99.998%.

Texcell

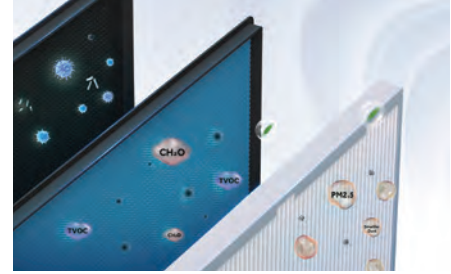

Antibacterial filter

Silver (Ag) is a natural antibacterial material, which has a broad-spectrum of antibacterial properties which help to kill bacterial.

Haier's antibacterial filter has added silver ions and antibacterial organics to kill Escherichia coli & Staphylococcus aureus effectively, with long lasting effects.

Self-clean function

During operation, dirt accumulates on the evaporator. If the evaporator is not cleaned regularly, accumulated dirt reduces the thermal exchange by 15-30% and also promotes the proliferation of bacteria and mould.

Self Clean technology is the first of its kind to integrate the self-cleaning function of both the evaporator and the condenser. It starts with cleaning the evaporator, then switches to cleaning the condenser without stopping the compressor.



Cold expansion technology



The layer of frost that forms on the evaporator/condenser generates a strong force of cold expansion that easily removes dirt from the surface.

Express washing technology



Low-angle hydrophilic aluminium foil speeds up water drainage by 20%.

Antibacterial technology

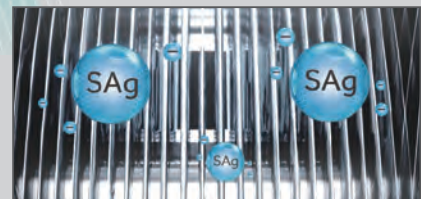

The coating contains silver nanoparticles capable of effectively killing 99% of the bacteria by inhibiting their proliferation.

MRV SLIM DUCTED 3D AIR SUPPLY

High quality components

Robust and high quality materials used for the fascia means that it is resistant to high temperatures.

Modern display

Simple and low profile temperature display with colour indication of cooling or heating mode. Which can be switched on and off

Easy Disassembly

Quick access to the air inlet grille which allows for easy cleaning.

Aesthetic design

The Modern and streamline design of the MRV Slim Duct unit comes with a simple white front and underside panel to suit any interior environment.

Three-dimensional air supply

With a free vertical range of motion between 30-80 degrees and a horizontal range of motion of around 90 degrees, this provides a three dimensional air flow for your environment.

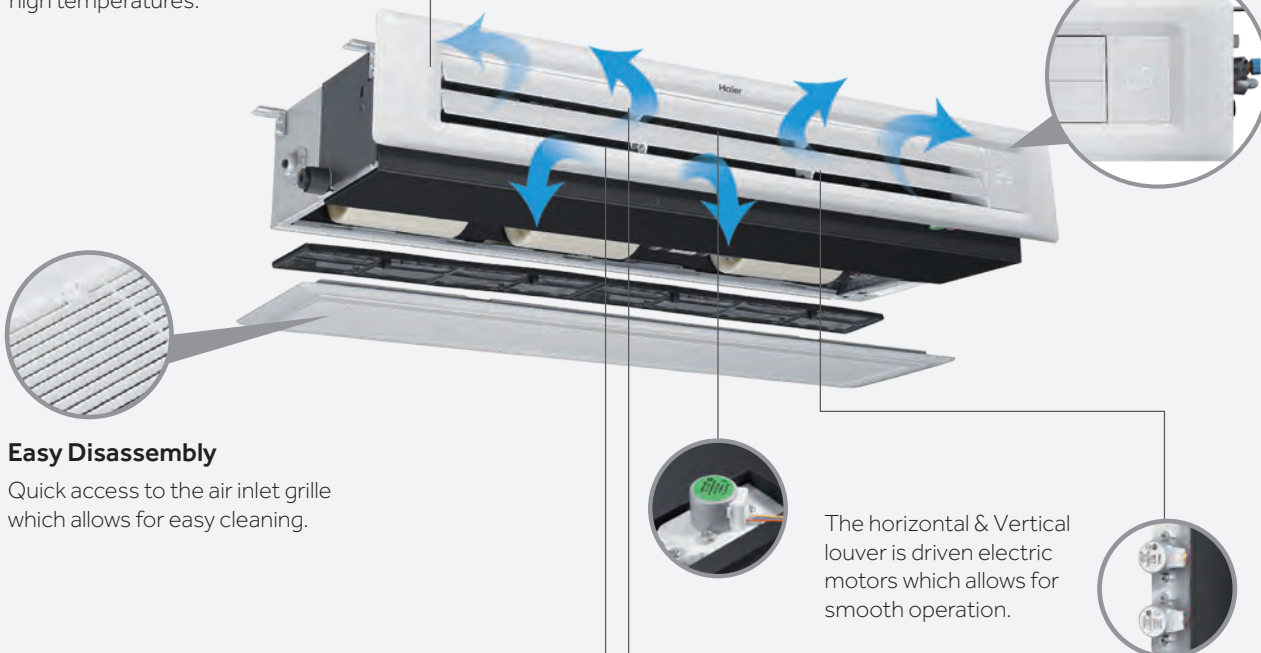

P1B-890IA/D / P1B-1210IA/D
Panel Kit **OPTIONAL**

Panel with built-in receiver for infrared remote control and on/off temperature info display



Air discharge grill equipped with vertical and horizontal 3D effect motorised fins



Air intake grill equipped with filter



AD052MSERA(H)
AD072MSERA(H)
AD092MSERA(H)
AD122MSERA(H)
AD162MSERA(H)
AD182MSERA(H)
AD242MSERA(H)



*Until stocks last.



Optional controller
HW-BA101ABT



Optional controller
HW-SA201ABK



Optional remote control
YR-HQS01

R410A Units are compatible with R32 wired controllers*

- Ideal for bedrooms, hotel rooms and quiet environments
- Extremely thin, only 185 mm
- Ready for fresh air input (pre-cut)
- Standard condensate drain pump
- Intake of lower or rear air by moving the panel as standard
- Silent operation
- Incorporates standard UVC ray generator to sterilize the air that flows through the unit
- Designed for free-mount installation without duct, with a standard prevalence of 0 PA. You can increase static pressure to 15 or 30 PA
- Possibility of optional functional aesthetic control kit panel
- DC inverter fan motor
- 5 fan speeds selectable with wired controller
- Rear or bottom air return

Model		AD052MSERA(H)	AD072MSERA(H)	AD092MSERA(H)	AD122MSERA(H)	AD162MSERA(H)	AD182MSERA(H)	AD242MSERA(H)
Capacity								
Cooling	kW	1.50	2.20	2.80	3.60	4.50	5.60	7.10
Heating	kW	1.70	2.50	3.20	4.00	5.00	6.30	8.00
Electrical Parameters								
Power supply	Ph/V/Hz	1 / 220-240 / 50						
Ventilation								
Air flow (H/M/L)	m³/h	430/370/310	480/420/360	480/420/360	550/430/370	600/540/460	800/690/580	930/850/750
Sound pressure level (H/M/L)	dB(A)	26/22/19	27/23/20	27/23/20	30/27/24	32/29/26	33/30/27	36/33/30
Sound power level (H/M/L)	dB(A)	40/36/33	41/37/34	41/37/34	44/41/38	46/43/40	47/44/41	50/47/43
Installation – Dimensions								
Unit Dimensions WxDxH	mm	850x420x185	850x420x185	850x420x185	850x420x185	850x420x185	1170x420x185	1170x420x185
Packaged unit dimensions WxDxH	mm	1045x540x270	1045x540x270	1045x540x270	1045x540x270	1045x540x270	1365x540x270	1365x540x270
Net weight / Gross weight	Kg	16,5/21,5	17,5/22,5	17,5/22,5	17,5/22,5	18,5/23,5	22,2/28,2	24,0/30,0
Ø Liquid side refrigerant pipe	mm (inch)	6,35 (1/4)	6,35 (1/4)	6,35 (1/4)	6,35 (1/4)	6,35 (1/4)	6,35 (1/4)	9,52 (3/8)
Ø Gas side refrigerant pipe	mm (inch)	9,52 (3/8)	9,52 (3/8)	9,52 (3/8)	12,70 (1/2)	12,70 (1/2)	12,70 (1/2)	15,88 (5/8)
Static pressure (Standard / Max)	Pa	0/15/30	0/15/30	0/15/30	0/15/30	0/15/30	0/15/30	0/15/30
Panel								
Model		P1B-890IA/D	P1B-890IA/D	P1B-890IA/D	P1B-890IA/D	P1B-890IA/D	P1B-1210IA/D	P1B-1210IA/D
Dimensions WxDxH (delivery deflector)	mm	890x190x100	890x190x100	890x190x100	890x190x100	890x190x100	1210x190x100	1210x190x100
Dimensions WxDxH (intake panel with filter)	mm	890x290,5x32,4	890x290,5x32,4	890x290,5x32,4	890x290,5x32,4	890x290,5x32,4	1210x290,5x32,4	1210x290,5x32,4
Packaging dimensions WxDxH	mm	938x335x220	938x335x220	938x335x220	938x335x220	938x335x220	1258x335x220	1258x335x220
Net weight / Gross weight	Kg	4,0/5,0	4,0/5,0	4,0/5,0	4,0/5,0	4,0/5,0	5,0/6,0	5,0/6,0

AD042MSFRA
AD052MSFRA
AD072MSFRA
AD092MSFRA
AD122MSFRA
AD162MSFRA
AD182MSFRA
AD242MSFRA

AD**2MSFRAC
External Valve



Can be installed vertically



Suitable for use in R410A Systems



Optional controller
HW-BA316AFK



Optional controller
HW-SA301AFK



Optional controller
HW-PB101AFK



Optional controller
YR-HQS01

- Ideal for bedrooms, hotel rooms and quiet environments
- Extremely thin, only 198 mm
- Ready for fresh air input (pre-cut)
- Standard condensate drain pump
- Intake of lower or rear air by moving the panel as standard
- Silent operation
- Selectable static pressure of 0 Pa or 40 Pa
- Possibility of optional functional aesthetic control kit panel
- DC inverter fan motor
- 7 fan speeds selectable with wired controller
- Rear or bottom air return
- External EEV (Optional)
- Vertical / Horizontal installation Available

Model	AD042MSFRA		AD052MSFRA		AD072MSFRA		AD092MSFRA		AD122MSFRA		AD162MSFRA		AD182MSFRA		AD242MSFRA	
	AD042MSFRAC		AD052MSFRAC		AD072MSFRAC		AD092MSFRAC		AD122MSFRAC		AD162MSFRAC		AD182MSFRAC		AD242MSFRAC	
Capacity																
Cooling	kW	1.3	1.5	2.2	2.8	3.6	4.5	5.6	7.1							
Heating	kW	1.5	1.8	2.5	3.2	4	5	6.3	8							
Electrical Parameters																
Power supply	Ph/V/Hz	1 / 220-240 / 50														
Ventilation																
Air flow (H/M/L)	m ³ /h	385/280/210	385/280/210	495/360/270	528/384/288	660/480/360	820/600/450	990/720/540	1220/940/770							
Sound pressure level (H/M/L)	dB(A)	28/25/20	28/25/20	29/25/20	30/25/20	31/26/21	35/27/24	36/30/24	39/31/27							
Sound power level (H/M/L)	dB(A)	45/42/37	45/42/37	46/42/37	47/42/37	48/43/38	52/44/41	53/47/41	56/48/44							
Installation – Dimensions																
Unit Dimensions WxDxH	mm	550x450x198	550x450x198	550x450x198	550x450x198	700x450x198	700x450x198	900x450x198	1100x450x198							
Packaged unit dimensions WxDxH	mm	823x597x285	823x597x285	823x597x285	823x597x285	973x597x285	973x597x285	1173x597x285	1373x597x285							
Net weight	Kg	11,9/12	11,9/12	11,9/12	11,9/12	13,4/13,5	13,9/13,8	16,5/16,4	20/19,9							
Gross weight	Kg	18/18,9	18/18,9	18/18,9	18/18,9	20/20,9	20,4/21,3	23,5/24,4	28/28,9							
Ø Liquid side refrigerant pipe	mm(inch)	6.35 (1/4)	6.35 (1/4)	6.35 (1/4)	6.35 (1/4)	6.35 (1/4)	6.35 (1/4)	6.35 (1/4)	9.52 (3/8)							
Ø Gas side refrigerant pipe	mm(inch)	9.52 (3/8)	9.52 (3/8)	9.52 (3/8)	9.52 (3/8)	12.70 (1/2)	12.70 (1/2)	12.70 (1/2)	15.88 (5/8)							
Static pressure (Standard / Max)	Pa	0-40	0-40	0-40	0-40	0-40	0-40	0-40	0-40							

The data in this catalogue is purely indicative as the data may vary. Please be advised to check the accuracy of the data with the supplier before purchasing products.

Haier **NEW** MRV INDOOR UNIT Compact Ducted Low - Med (50/90Pa)

Can be installed vertically



AD042MSFRAM
AD052MSFRAM
AD072MSFRAM
AD092MSFRAM
AD122MSFRAM
AD162MSFRAM
AD182MSFRAM

AD**2MSFRAD
External Valve



Suitable for use in R410A Systems



Optional controller
HW-BA316AFK



Optional controller
HW-SA301AFK



Optional controller
HW-PB101AFK



Optional controller
YR-HQS01

- Ideal for bedrooms, hotel rooms and quiet environments
- Extremely thin, only 198 mm
- Ready for fresh air input (pre-cut)
- Standard condensate drain pump
- Intake of lower or rear air by moving the panel as standard
- Silent operation
- Selectable static pressure of 50 Pa or 90 Pa
- Possibility of optional functional aesthetic control kit panel
- DC inverter fan motor
- 7 fan speeds selectable with wired controller
- Rear or bottom air return
- External EEV (Optional)
- Vertical / Horizontal installation Available

Model	AD042MSFRAM		AD052MSFRAM		AD072MSFRAM		AD092MSFRAM		AD122MSFRAM		AD162MSFRAM		AD182MSFRAM	
	AD042MSFRAD		AD052MSFRAD		AD072MSFRAD		AD092MSFRAD		AD122MSFRAD		AD162MSFRAD		AD182MSFRAD	
Capacity														
Cooling	kW	1,3	1,5	2,2	2,8	3,6	4,5	5,6						
Heating	kW	1,5	1,8	2,5	3,2	4	5	6,3						
Electrical Parameters														
Power supply	Ph/V/Hz	1 / 220-240 / 50												
Ventilation														
Air flow (H/M/L)	m³/h	385/280/210	385/280/210	495/360/270	528/384/288	660/480/360	820/600/450	990/720/540						
Sound pressure level (H/M/L)	dB(A)	33/27/22	33/27/22	37/31/25	41/35/28	40/32/26	42/35/28	43/36/29						
Sound power level (H/M/L)	dB(A)	50/42/39	50/44/39	54/48/42	58/52/45	57/49/43	59/52/45	60/53/46						
Installation – Dimensions														
Unit Dimensions WxDxH	mm	700x450x198	700x450x198	700x450x198	700x450x198	900x450x198	1100x450x198	1100x450x198						
Packaged unit dimensions WxDxH	mm	973x597x285	973x597x285	973x597x285	973x597x285	1173x597x285	1373x597x285	1373x597x285						
Net weight	Kg	13,4/13,5	13,4/13,5	13,4/13,5	13,8/13,9	16,4/16,5	19,9/20	19,9/20						
Gross weight	Kg	20/20,9	20/20,9	20/20,9	20,4/21,3	23,5/24,4	28/28,9	28/28,9						
Ø Liquid side refrigerant pipe	mm(inch)	6,35 (1/4)	6,35 (1/4)	6,35 (1/4)	6,35 (1/4)	6,35 (1/4)	6,35 (1/4)	6,35 (1/4)						
Ø Gas side refrigerant pipe	mm(inch)	9,52 (3/8)	9,52 (3/8)	9,52 (3/8)	9,52 (3/8)	12,7 (1/2)	12,7 (1/2)	12,7 (1/2)						
Static pressure (Standard / Max)	Pa	50-90	50-90	50-90	50-90	50-90	50-90	50-90						



AD482MJERAF
AD722MTERAF
AD962MTERAF



Optional controller
HW-BA101ABT



Optional controller
HW-SA201ABK



Optional remote control
YR-HQS01

R410A Units are compatible with R32 wired controllers*

- Selectable ESP
- Speed Selection (16 speed for AD722/962MTERAF and 10 speed for AD482MTERAF)
- Can be installed together with other indoor units on the same refrigerating circuit, to pre-treat the outdoor air before sending it to indoor units or in the environment
- Take note that the nominal potential in heating is always lower than that of cooling
- Integrated flow switch
- DC inverter fan motor

Model		AD482MJERAF	AD722MTERAF	AD962MTERAF
Capacity				
Cooling	kW	14,00	22,60	28,00
Heating	kW	8,90	15,20	17,80
Electrical Parameters				
Power supply	Ph/V/Hz	1 / 220-240 / 50	1 / 220-240 / 50	1 / 220-240 / 50
Ventilation				
Air flow (H/M/L)	m ³ /h	1600/1460/1070	4000/3500/3000	4500/4000/3600
Sound pressure (H/M/L)	dB(A)	48/47/42	50/47/44	51/48/45
Sound power (H/M/L)	dB(A)	61/60/56	68/65/60	68/66/62
Installation – Dimensions				
Net dimensions (WxDxH)	mm	1500x700x248	1512x856x502	11512x856x502
Packaged unit dimensions (WxDxH)	mm	1718x848x345	1558x896x612	1558x896x612
Net/gross weight	Kg	43,6/50,4	102,0/116,0	102,0/116,0
Ø Liquid pipe	mm (inch)	9,52 (3/8)	12,70 (1/2)	12,70 (1/2)
Ø Gas pipe	mm (inch)	15,88 (5/8)	22,22 (7/8)	22,22 (7/8)
Static pressure (Standard/Max.)	Pa	100/200	100/250	100/250



- AD052MJERA(H)
- AD072MJERA(H)
- AD092MJERA(H)
- AD122MJERA(H)
- AD162MJERA(H)
- AD182MJERA(H)
- AD242MJERA(H)
- AD282MJERA(H)
- AD302MJERA(H)
- AD382MJERA(H)
- AD482MJERA(H)
- AD542MJERA(H)

*Until stocks last.



The inbuilt UV-C ray emitter module performs an effective and efficient air sterilization both on the unit's coil surface and the air that passes through. This module's performance has been certified by the independent laboratory Texcell.



Optional controller
HW-BA101ABT



Optional controller
HW-SA201ABK



Optional remote control
YR-HQS01

R410A Units are compatible with R32 wired controllers*

- Compact Ducted Med-High Pressure
- Static pressure fan 20 / 200 Pa.
- The standard static pressure is 20 Pa.
- Selectable ESP from 20 Pa to 200 Pa by using a wired controller
- Standard condensate drain pump
- Incorporates standard UVC ray generator to sterilize the air that flows through the unit
- Only 248mm Height

Model		AD052MJERA(H)	AD072MJERA(H)	AD092MJERA(H)	AD122MJERA(H)	AD162MJERA(H)	AD182MJERA(H)	AD242MJERA(H)	AD282MJERA(H)	AD302MJERA(H)	AD382MJERA(H)	AD482MJERA(H)	AD542MJERA(H)	
Capacity														
Cooling	kW	1,50	2,20	2,80	3,60	4,50	5,60	7,10	8,00	9,00	11,20	14,00	16,00	
Heating	kW	1,70	2,50	3,20	4,00	5,00	6,30	8,00	9,00	10,00	13,00	16,30	18,00	
Electrical Parameters														
Power supply	Ph/V/Hz	1 / 220-240 / 50												
Ventilation														
Air flow (H/M/L)	m ³ /h	515/ 440/390	545/ 470/390	545/ 470/390	570/ 495/420	700/ 625/550	915/ 765/640	1275/ 1050/875	1275/ 1050/875	1450/ 1200/1000	2000/ 1700/1400	2150/ 1750/1400	2350/ 1950/1600	
Sound pressure (H/M/L)	dB(A)	29/27/25	30/28/25	30/28/25	31/29/27	32/30/28	33/31/29	34/31/29	35/33/30	36/33/30	38/35/32	40/36/32	42/38/34	
Sound power (H/M/L)	dB(A)	41/39/37	42/40/37	42/40/37	43/41/39	44/42/40	45/43/41	46/43/41	47/45/42	48/45/42	50/47/44	52/48/44	54/50/46	
Installation – Dimensions														
Net dimensions (WxDxH)	mm	700x700x248					1100x700x248				1500x700x248			
Packaged unit dimensions (WxDxH)	mm	932x835x280					1332x835x280				1698x857x305			
Net/gross weight	Kg	27,0/32,0	27,0/32,0	27,0/32,0	27,0/32,0	28,5/33,5	36,8/43,4	36,8/43,4	36,8/43,4	39,4/45,4	48,3/56,5	51,3/59,5	51,3/59,5	
Ø Liquid pipe	mm (inch)	6,35 (1/4)	6,35 (1/4)	6,35 (1/4)	6,35 (1/4)	6,35 (1/4)	6,35 (1/4)	9,52 (3/8)	9,52 (3/8)	9,52 (3/8)	9,52 (3/8)	9,52 (3/8)	9,52 (3/8)	
Ø Gas pipe	mm (inch)	9,52 (3/8)	9,52 (3/8)	9,52 (3/8)	12,70 (1/2)	12,70 (1/2)	12,70 (1/2)	15,88 (5/8)	15,88 (5/8)	15,88 (5/8)	15,88 (5/8)	15,88 (5/8)	15,88 (5/8)	
Static pressure (Standard/Max.)	Pa	20/200	20/200	20/200	20/200	20/200	20/200	20/200	20/200	20/180	20/180	20/180	20/180	

AD052MJFRA
AD072MJFRA
AD092MJFRA
AD122MJFRA
AD162MJFRA
AD182MJFRA
AD242MJFRA
AD282MJFRA
AD302MJFRA
AD382MJFRA
AD482MJFRA
AD542MJFRA



Suitable for use in R410A Systems



The inbuilt UV-C ray emitter module performs an effective and efficient air sterilization both on the unit's coil surface and the air that passes through. This module's performance has been certified by the independent laboratory Texcell.



Optional controller
HW-SA301AFK



Optional controller
HW-PB101AFK



Optional controller
YR-HQS01

- Compact Ducted Med-High Pressure
- Static pressure fan 20 - 200 Pa ESP.
- Selectable ESP from 20 Pa to 200 Pa by using a wired controller
- Standard condensate drain pump
- Incorporates standard UVC ray generator to sterilize the air that flows through the unit
- Only 248mm Height

Model		AD052MJFRA	AD072MJFRA	AD092MJFRA	AD122MJFRA	AD162MJFRA	AD182MJFRA	AD242MJFRA	AD282MJFRA	AD302MJFRA	AD382MJFRA	AD482MJFRA	AD542MJFRA	
Capacity														
Cooling	kW	1,5	2,2	2,8	3,6	4,5	5,6	7,1	8	9	11,2	14	16	
Heating	kW	1,7	2,5	3,2	4	5	6,3	8	9	10	13	16,3	18	
Electrical Parameters														
Power supply	Ph/V/Hz	1 / 220-240 / 50												
Ventilation														
Air flow (H/M/L)	m ³ /h	545/432/296	550/470/343	557/508/380	576/495/380	712/625/533	1035/835/453	1317/875/556	1345/1050/628	1450/1000/600	2055/1400/725	2150/1400/690	2350/1600/908	
Sound pressure (H/M/L)	dB(A)	30/27/25	30/28/26	30/29/26	31/29/26	32/30/28	34/32/28	35/33/29	36/34/30	37/34/30	39/35/32	41/35/32	43/36/33	
Sound power (H/M/L)	dB(A)	44/41/39	44/42/40	44/43/40	45/43/40	46/44/42	48/46/42	49/47/43	50/48/44	51/48/44	53/49/46	55/49/46	57/50/47	
Installation – Dimensions														
Net dimensions (WxDxH)	mm	700x700x248					1100x700x248				1500x700x248			
Packaged unit dimensions (WxDxH)	mm	914x866x335					1314x866x335				1714x866x335			
Net/gross weight	Kg	25/30	25/30	25/30	25/30,7	26,2/31,9	34/40,5	34/40,5	34/40,5	36/42,5	44,2/53,5	47,2/56,5	47,2/56,5	
Ø Liquid pipe	mm (inch)	6,35 (1/4)	6,35 (1/4)	6,35 (1/4)	6,35 (1/4)	6,35 (1/4)	6,35 (1/4)	9,52 (3/8)	9,52 (3/8)	9,52 (3/8)	9,52 (3/8)	9,52 (3/8)	9,52 (3/8)	
Ø Gas pipe	mm (inch)	9,52 (3/8)	9,52 (3/8)	9,52 (3/8)	12,7 (1/2)	12,7 (1/2)	12,7 (1/2)	15,88 (5/8)	15,88(5/8)	15,88(5/8)	15,88(5/8)	15,88(5/8)	15,88(5/8)	
Static pressure (Standard/Max.)	Pa	20/200	20/200	20/200	20/200	20/200	20/200	20/200	20/200	20/180	20/180	20/180	20/180	

The data in this catalogue is purely indicative as the data may vary. Please be advised to check the accuracy of the data with the supplier before purchasing products.



AD722MTERAD
AD962MTERAD

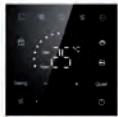

Optional controller
HW-BA101ABT



Optional controller
HW-SA201ABK



Optional remote control
YR-HQS01

R410A Units are compatible with R32 wired controllers*

- Flexible and simple ductwork
- Simple maintenance
- Selectable ESP from 100 Pa to 300 Pa by using a wired controller
- Condensate drain pump not included
- 3 speeds + booster

Model		AD722MTERAD	AD962MTERAD
Capacity			
Cooling	kW	22,60	28,00
Heating	kW	25,20	31,50
Electrical Parameters			
Power supply	Ph/V/Hz	1/220-240/50	1/220-240/50
Ventilation			
Air flow (H/M/L)	m ³ /h	4000/3600/3200	4500/3700/3300
Sound pressure level (H/L)	dB(A)	50/46	51/47
Sound power level (H/L)	dB(A)	64/60	65/61
Installation – Dimensions			
Unit Dimensions WxDxH	mm	1438x748x495	1438x748x495
Packaged unit dimensions WxDxH	mm	1558x896x652	1558x896x652
Net weight / Gross weight	Kg	86/102	86/102
Ø Liquid side refrigerant pipe	mm (inch)	12,70 (1/2)	12,70 (1/2)
Ø Gas side refrigerant pipe	mm (inch)	22,22 (7/8)	22,22 (7/8)
Static pressure (Standard / Max)	Pa	100/300	100/300



HU092WVLNA
HU162WVLNA
HU312WVLNA



Model			HU092WVLNA	HU162WVLNA	HU312WVLNA
Nominal capacity	Cooling (1)	kW	7	14	28
	Heating (2)	kW	9	16	31
Dimensions Unit	H x W x D	mm	850 × 480 × 310	850 × 480 × 310	850 × 480 × 310
Weight Unit		Kg	56	56	52
Installation place	Indoor/outdoor		Indoor	Indoor	Indoor
Combination ratio	Only hydro module	%	50-100%	50-100%	50-100%
	Hydro box+IDUs	%	50-130%	50-130%	50-130%
Cooling Ambient	Min. - Max.	°CDB	10~43	10~43	10~43
Cooling Water side	Min. - Max.	°C	5~20	5~20	5~20
Heating Ambient	Min. - Max.	°C	-20~24	-20~24	-20~24
Water side	Min. - Max.	°C	20~50	20~50	20~50
Sound pressure level	Cooling/Heating	dB(A)	29/ 32	29/32	29/32
Sound power level		dB(A)	42	46	48
Water flow rate	Min-Standard	L/min	18/26	32/46	63/90
Water circuit Piping diameter	Inlet	inch "	1	1	1-1/4
	Outlet	inch "	1	1	1-1/4
Refrigerant Type			R410A	R410A	R410A
Gas side - connection type		mm	15,88 (5/8)	15,88 (5/8)	19,05 (3/4)
Liquid side - connection type		mm	9,52 (3/8)	9,52 (3/8)	9,52 (3/8)
Power supply		Ph / Hz / V	1/ 50/ 220-240	1/ 50/ 220-240	1/ 50/ 220-240
ODU compatibility	MRV 5, MRV 5-RC, MRV 5-H, MRV S 8-10-12HP				

(1) Tamb 35°C - LWE 18°C (DT=5°C)

(2) DB/WB 7°C/6°C - LWC 35°C (DT=5°C)

MRV HYDROBOX – FEATURES

LOW OPERATING COST

By using free renewable energy from the outside air as heat source, it is more energy efficient and environmentally friendlier than oil and gas boilers. The operating cost is low due to high efficiency heat pump and heat recovery technology.

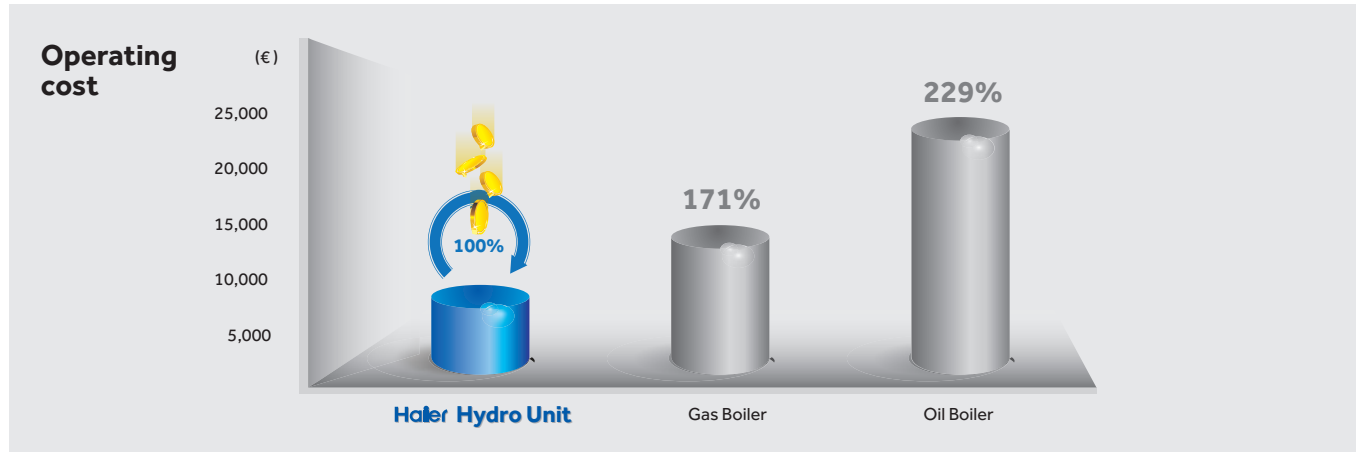

COMFORT

The hydro box unit has a heating capacity of up to 28kW per module which can be used in combination for larger systems. The leaving water temperature ranges from 5°C to 55°C, this provides desirable climate comfort to users. Connectible to MRV 5-H, MRV 5-RC and MRV SII.



MRV HYDROBOX – FEATURES

MULTIPLE HEATING AND COOLING SOLUTIONS CAN BE SELECTED TO PROVIDE:

1. ATA (AIR-TO-AIR) AND ATW (AIR-TO-WATER)

In the summer, ATA cooling and DHW (Domestic hot water) can be used. The heat pump outdoor and hydro unit can provide hot water to heat up water stored in the DHW tank when the MRV indoor units is not operating. The outdoor heat recovery can supply cooling and the hydro unit can provide a hot water supply at the same time.

In winter, ATA heating or hot water heating can be selected to warm the rooms, and DHW can still be heated up at the same time.

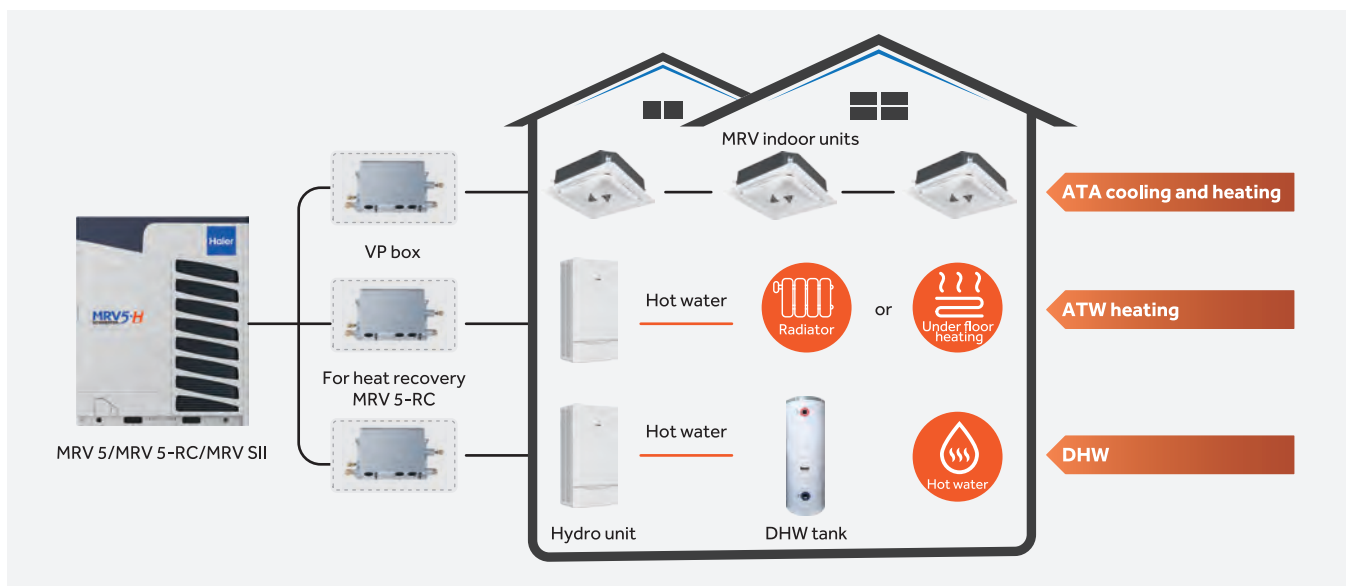

2. ONLY ATW (AIR-TO-WATER)

In summer, the outdoor heat pump and hydro unit can provide hot water to heat up water stored in the DHW tank when the fan coils or AHU cooling is not operated. In spring and autumn the outdoor heat recovery and hydro unit can provide hot water when the fan coils or AHU cooling is operating.

In winter, fan coils provide heating to warm the rooms, while the DHW is heated up at the same time.

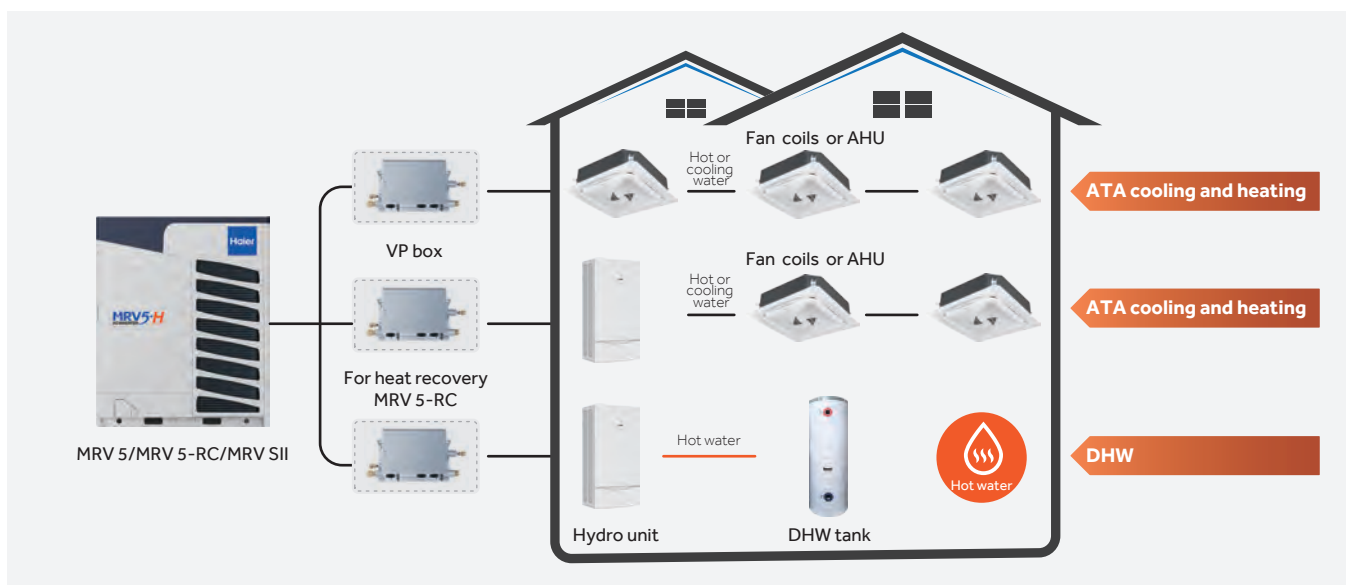

EASY MRV

Flexible,
high-efficiency
MRV systems

MS valves for
connecting residential
and commercial units



EASY MRV - FEATURES

EASY MRV SYSTEMS

Haier's "Easy MRV" system is the ideal solution for environments where an exceptionally low sound level is required by the indoor air conditioning unit.

Thanks to the external remote thermal expansion valves (MS valve box) it is possible to connect to our Supermatch indoor residential units. Which as standard are not equipped with a valve and ensure very low operating sound levels, to the MRV outdoor units (with some types of indoor units, you can reach 16 dBA). In addition, if you are looking for internal wall units with a modern and different design, with high class functionality and features, our FLEXIS and PEARL series connected to an "Easy MRV" system will meet your requirements.

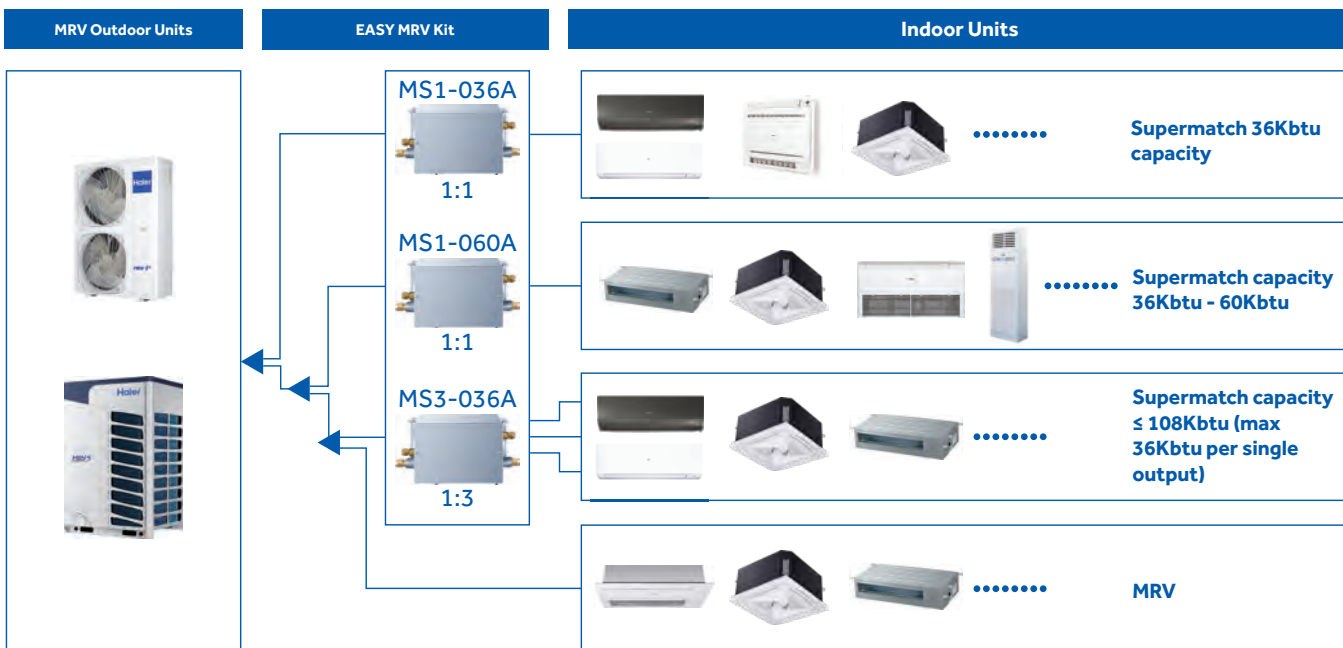

CONNECTIONS

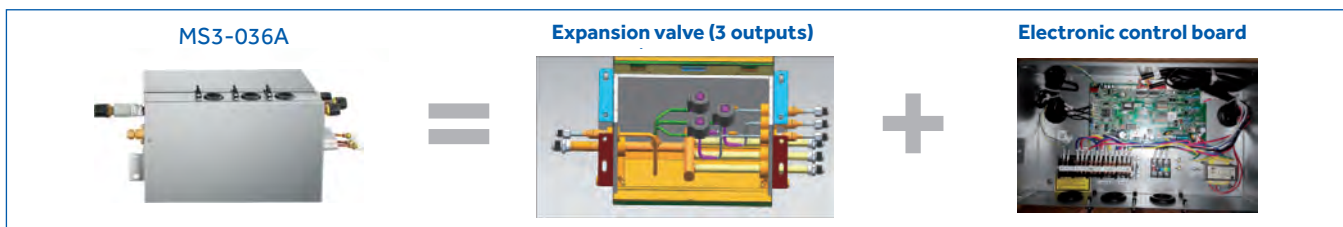

Haier's valve boxes have built-in gas pipes to facilitate installation without requiring welds due to utilising a flare connection.

For more information please refer to the Haier Residential and light commercial catalogue

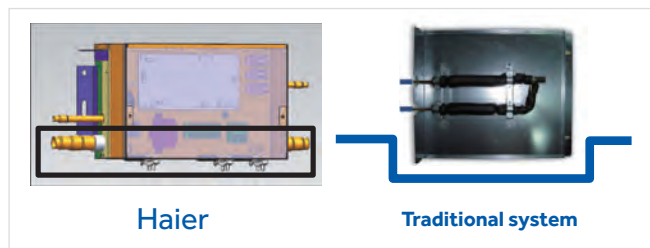



MS1-036A
MS1-060A



MS3-036A



Model		MS1-036A	MS1-060A	MS3-036A
Max number of indoor units	No.	1	1	3
Maximum connectable indoor unit capacity	Btu/h	≤ 36Kbtu	36Kbtu - 60Kbtu	≤ 36Kbtu per single output (Tot. max 108Kbtu)
	kW	11,2	11,2 to 18,0 kW	Max 33,6 kW (max 11,2 kW per single output)
Power supply	V-Ph-Hz	220~230-1-50/60	220~230-1-50/60	220~230-1-50/60
Dimensions WxDxH	mm	310x217x155	310x217x155	394x227x253
Shipping Dimensions WxDxH	mm	509x285x209	509x285x209	687x295x303
Net weight	Kg	5	5	9
Material		Galvanised steel	Galvanised steel	Galvanised steel
Colour		Grey	Grey	Grey
Liquid pipe Ø	mm	9,52 (male) / 6,35	9,52 (male) / 12,7	6,35 (male) / 9,52 - 9,52 (male) / 12,7
Gas pipe Ø	mm	15,88 (male) / 12,7 / 9,52	19,05 (male) / 15,88	19,05 (male) / 15,88 - 15,88 (male) / 12,7 / 9,52
Connection type		Flare connection	Flare connection	Flare connection
Maximum piping length (BOX - IU)	m	15	15	15
Maximum height difference of pipes (BOX - IU)	m	15	15	15

AS25 - AS35 - AS42

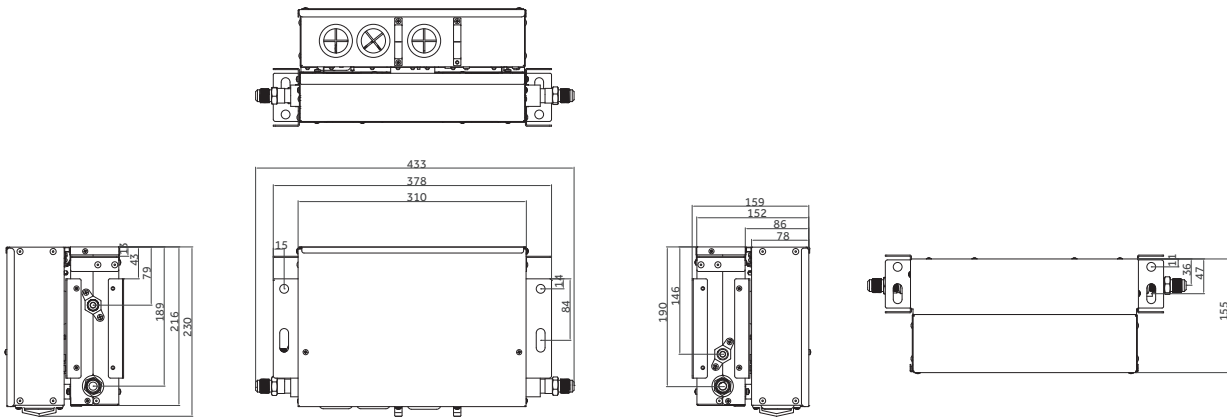

AS25 - AS35 - AS42

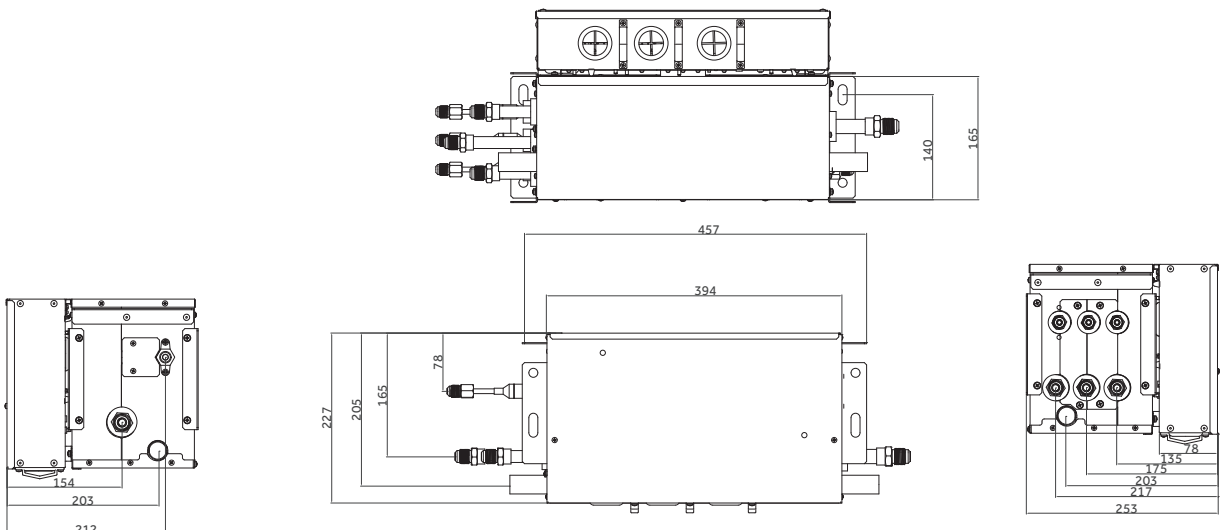

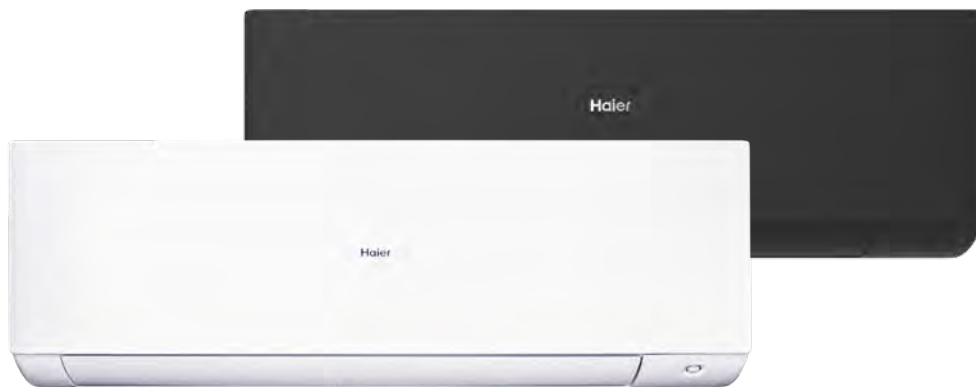

EXPERT White
 AS20XCAHRA
 AS25XCAHRA
 AS35XCAHRA
 AS50XCAHRA

EXPERT Black
 AS20XCAHRA-MB
 AS25XCAHRA-MB
 AS35XCAHRA-MB
 AS50XCAHRA-MB



Optional controller
HW-BA101ABT



Optional controller
HW-SA201ABK



Optional remote control
YR-HQS01

- Silent performance, down to 16db(A) 2,0kW and 2,5kW
- External EEV modulation valve
- ECO presence sensor to optimize the energy consumption and the airflow
- Standard Wi-Fi with hOn App
- 3D ventilation
- Easy installation thanks to the removable part in the bottom of the unit that gives access to the piping

MS1-036A/MS1-060A



MS3-036A



Model	AS20XCAHRA		AS25XCAHRA		AS35XCAHRA		AS50XCAHRA	
	AS20XCAHRA-MB		AS25XCAHRA-MB		AS35XCAHRA-MB		AS50XCAHRA-MB	
Capacity								
Cooling	kW	2.00	2.80	3.50	5.00			
Heating	kW	2.50	3.20	4.20	6.00			
Electrical Parameters								
Power supply	Ph/V/Hz	1/220-240/50						
Ventilation								
Air flow (H)	m³/h	730	730	800	880			
Sound pressure (H/M/L)	dB(A)	39/32/16	39/32/16	40/33/17	45/37/20			
Sound power	dB(A)	56	56	57	60			
Installation – Dimensions								
Net dimensions (WxDxH)	mm	895x313x236	895x313x236	895x313x236	895x313x236			
Packaged unit dimensions (WxDxH)	mm	964x386x316	964x386x316	964x386x316	964x386x316			
Net/gross weight	Kg	11,3/14	11,3/14	11,3/14	11,6/14,2			
Ø Liquid pipe	mm (inch)	6.35 (1/4)	6.35 (1/4)	6.35 (1/4)	6.35 (1/4)			
Ø Gas pipe	mm (inch)	9.52 (3/8)	9.52 (3/8)	9.52 (3/8)	12.7 (1/2)			

*Easy MRV kit needed to integrate with MRV system.



WK-B

^WK-B necessary to connect split high walls with wired controller



MRV

TECHNICAL DRAWINGS

MRV HYDROBOX

HU**2WVLNA

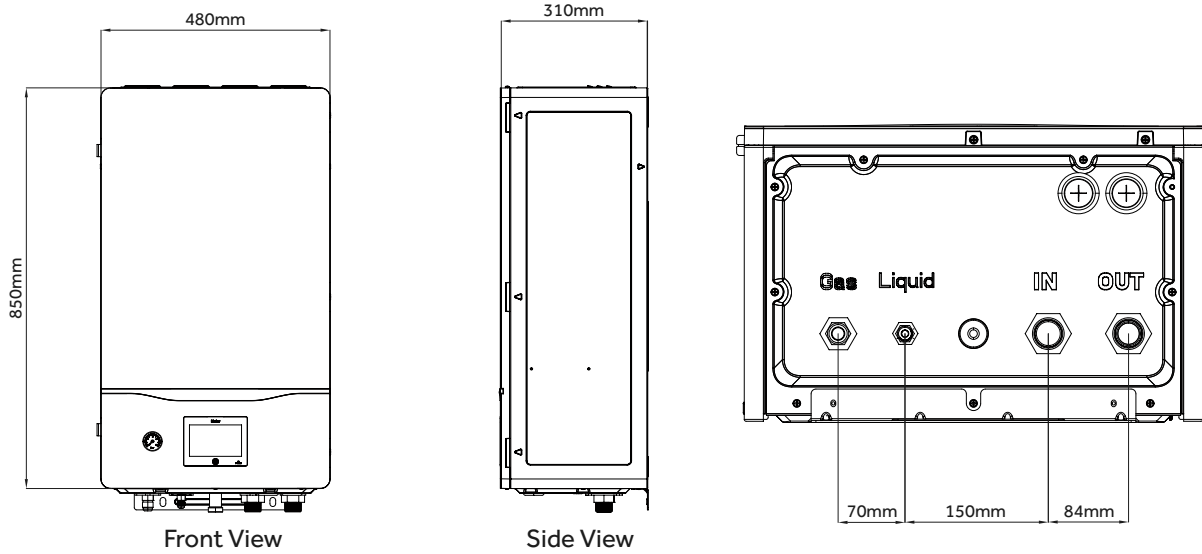

MRV INDOOR UNITS ROUND FLOW CASSETTE

AB**2MRERA

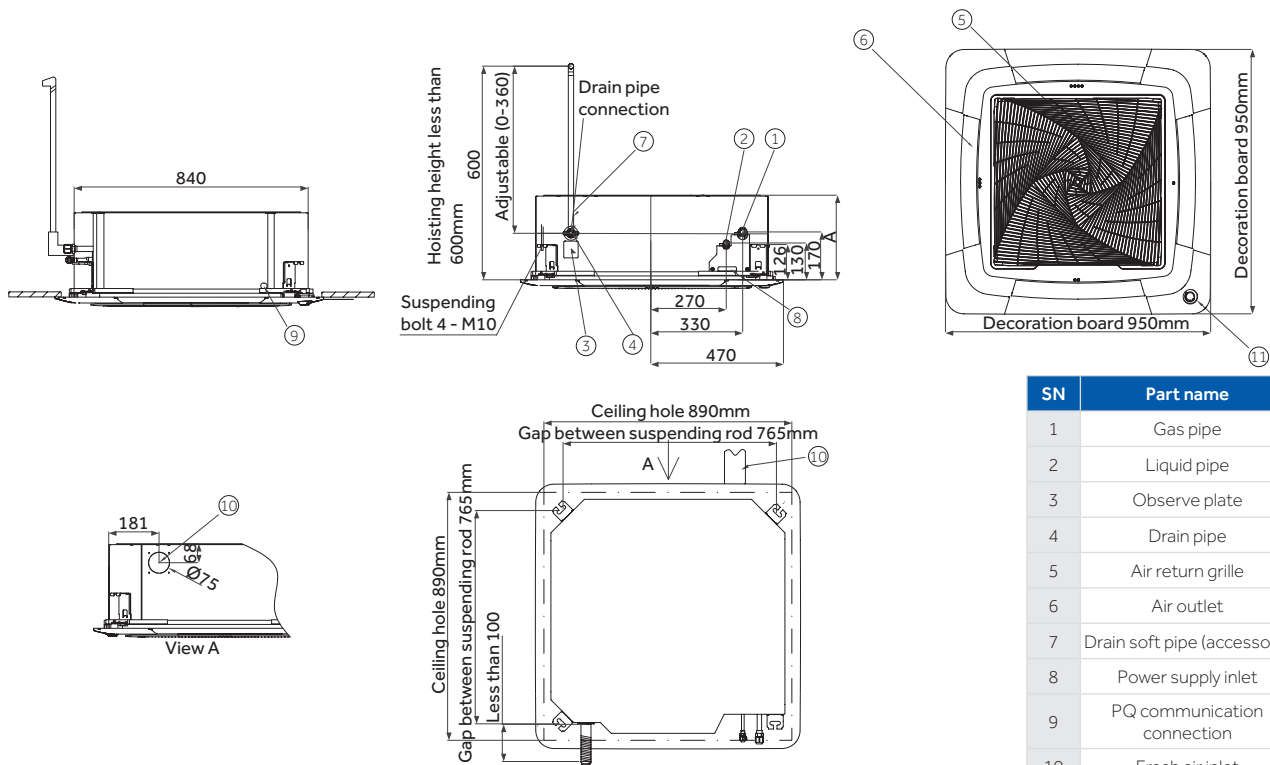

SN	Part name
1	Gas pipe
2	Liquid pipe
3	Observe plate
4	Drain pipe
5	Air return grille
6	Air outlet
7	Drain soft pipe (accessory)
8	Power supply inlet
9	PQ communication connection
10	Fresh air inlet
11	Move eye (optional)

MRV INDOOR UNITS ROUND FLOW CASSETTE

AB**2MNFRA

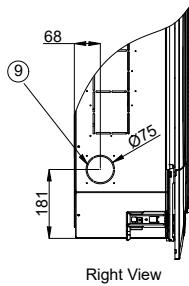

Right View

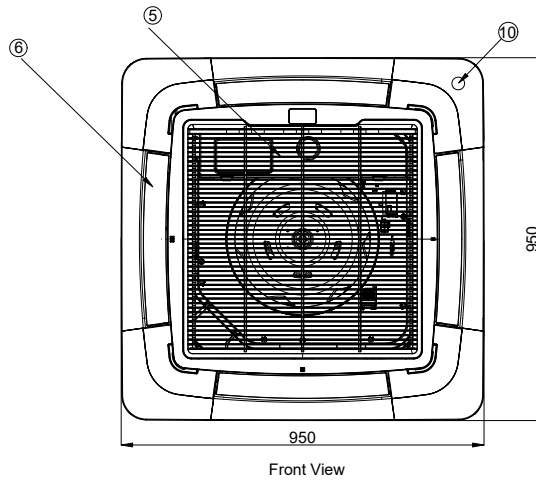

Front View

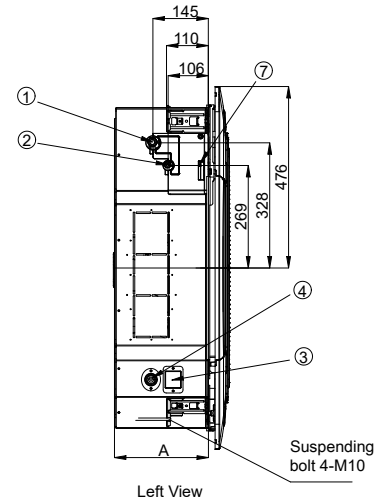

Left View

SN	Part name
1	Gas pipe
2	Liquid pipe
3	Observe plate
4	Drain pipe
5	Air return grille
6	Air outlet
7	Power supply inlet
8	Comms cable routing hole
9	Fresh air inlet
10	Human presence sensor

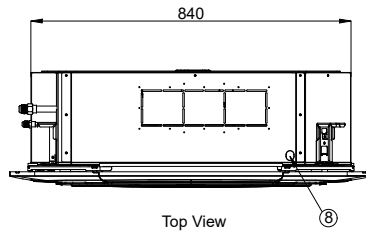

Top View

Unit: mm

MRV INDOOR UNIT CASSETTE 620

AB**2MCERA(M)

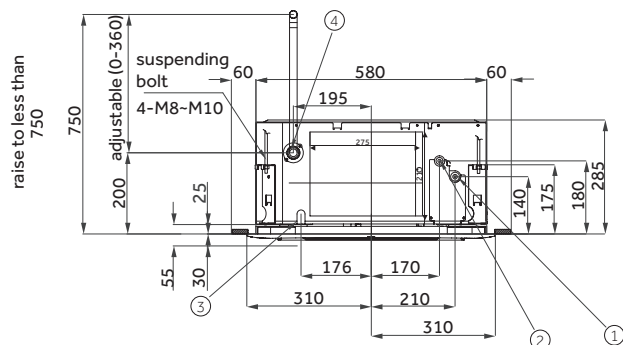
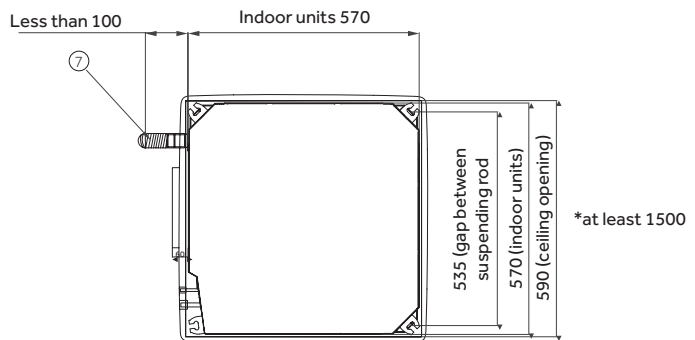
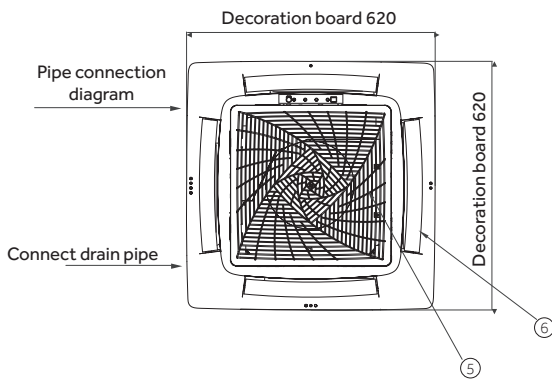

SN	Part name
1	Connection port of gas pipe
2	Connection liquid pipe
3	Wiring connection port of motor/pumping motor
4	Connect drain pipe
5	Inlet grill
6	Outlet grill
7	Drain hose (accessory)

MRV INDOOR UNIT CASSETTE 620

AB**2MCFRA

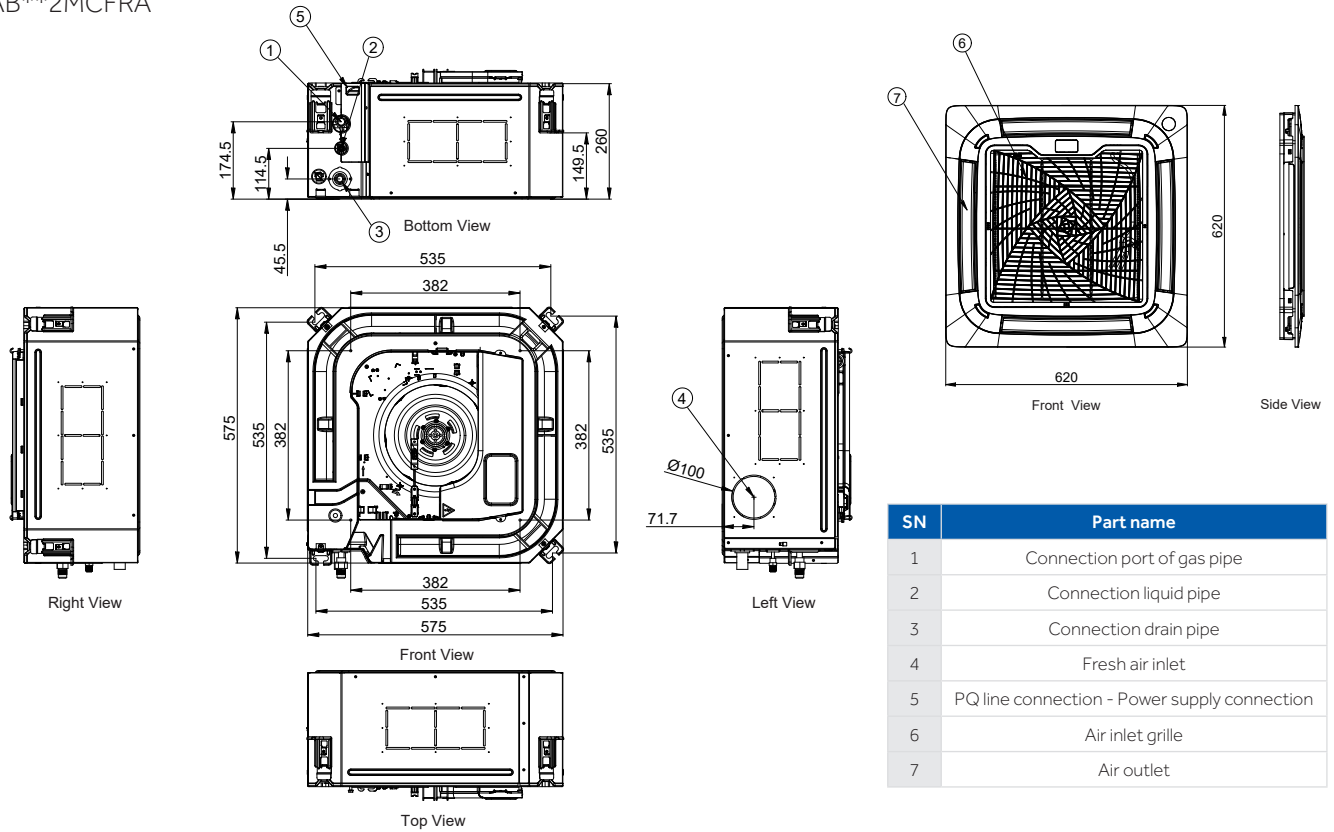

MRV INDOOR UNIT WALL MOUNTED (AS052 - AS122)

AS**2MNERAB

AS**2MFFRA

AS**2MNERAC

AS**2MFFRAC

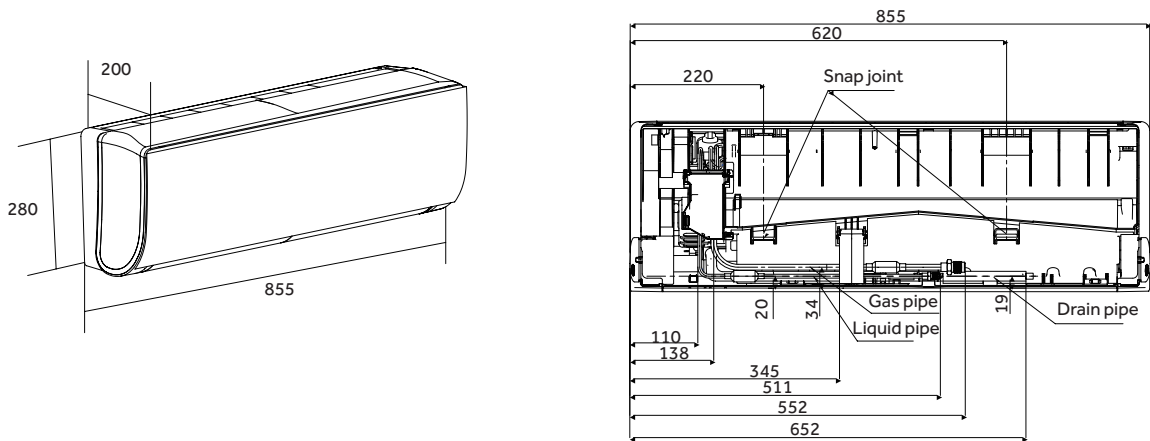

EXTERNAL EEV VALVE

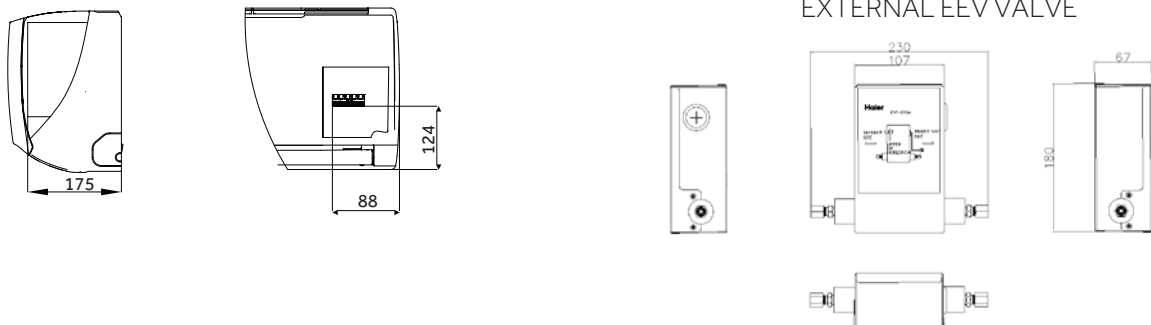

The data in this catalogue is purely indicative as the data may vary. Please be advised to check the accuracy of the data with the supplier before purchasing products.

MRV INDOOR UNIT WALL MOUNTED (AS162 - AS242)

AS**2MNERA
AS**2MNERAC

AS**2MFFRA
AS**2MFFRAC

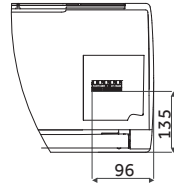
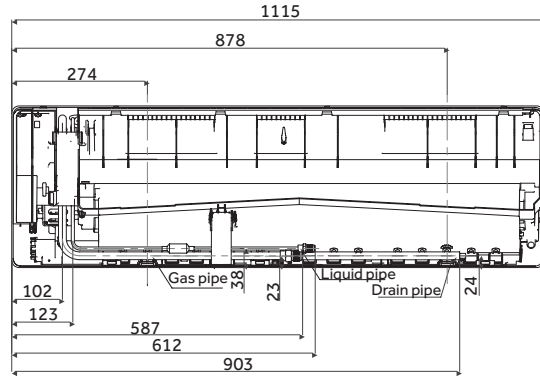
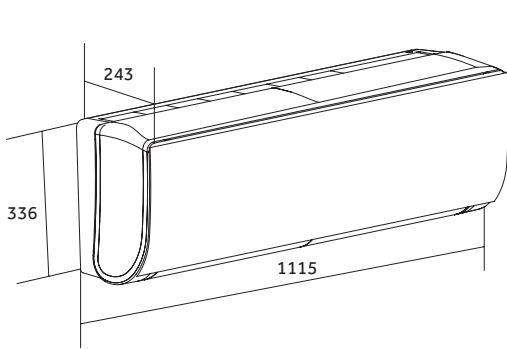

EXTERNAL EEV VALVE

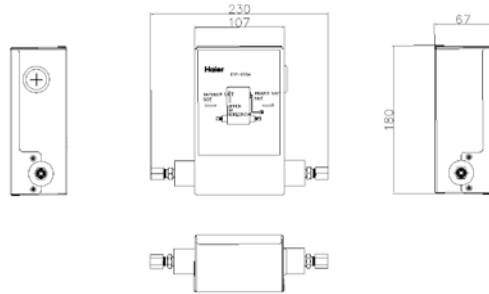

MRV INDOOR UNIT WALL MOUNTED (AS282 - AS302)

AS**2MNERA
AS**2MNERAC

AS**2MNFRA

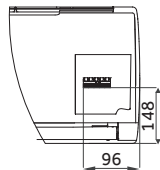
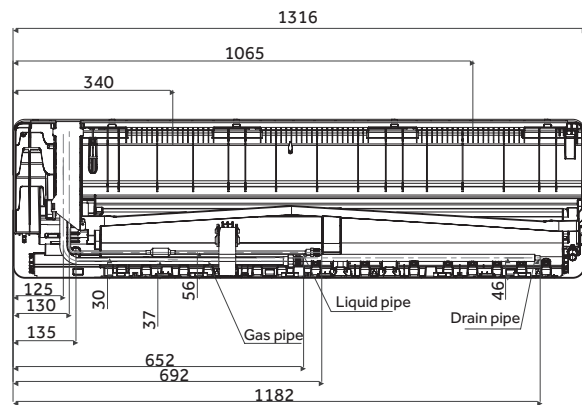
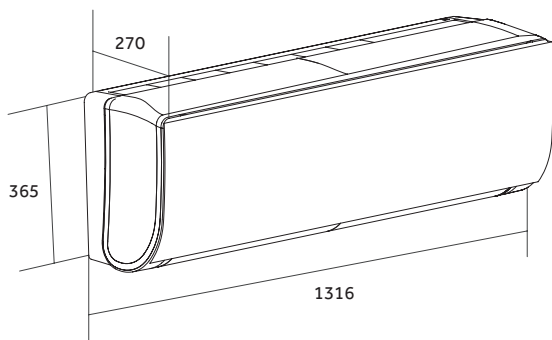

EXTERNAL EEV VALVE

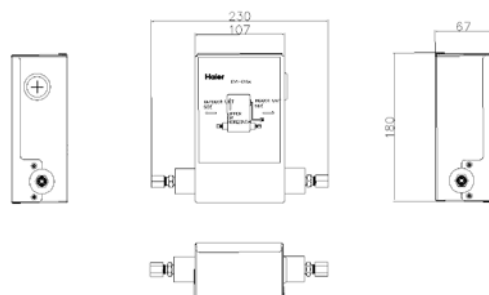

MRV INDOOR UNIT 1-WAY CASSETTE

AB**2MAERAD

AB052-162MAERAD

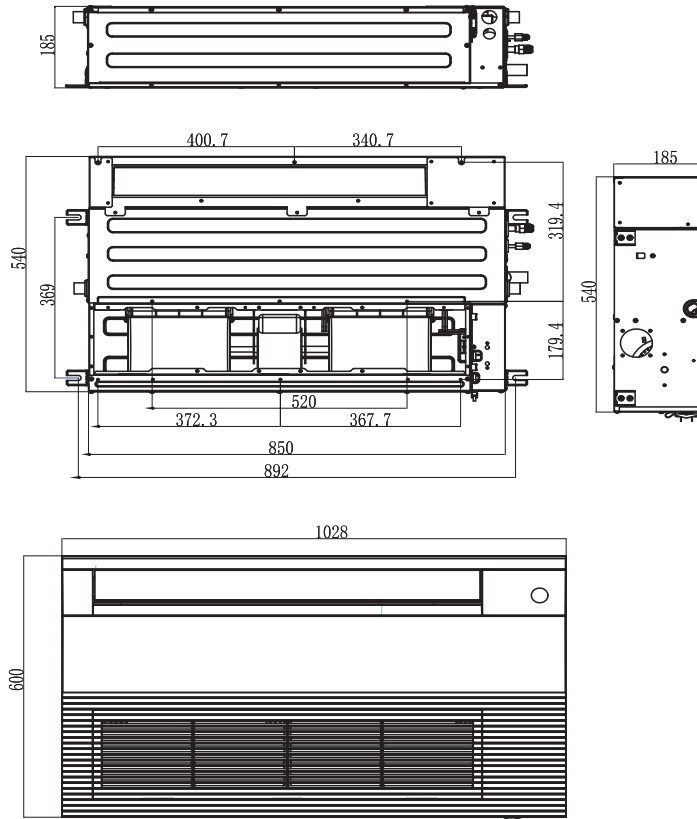

AB182-242MAERAD

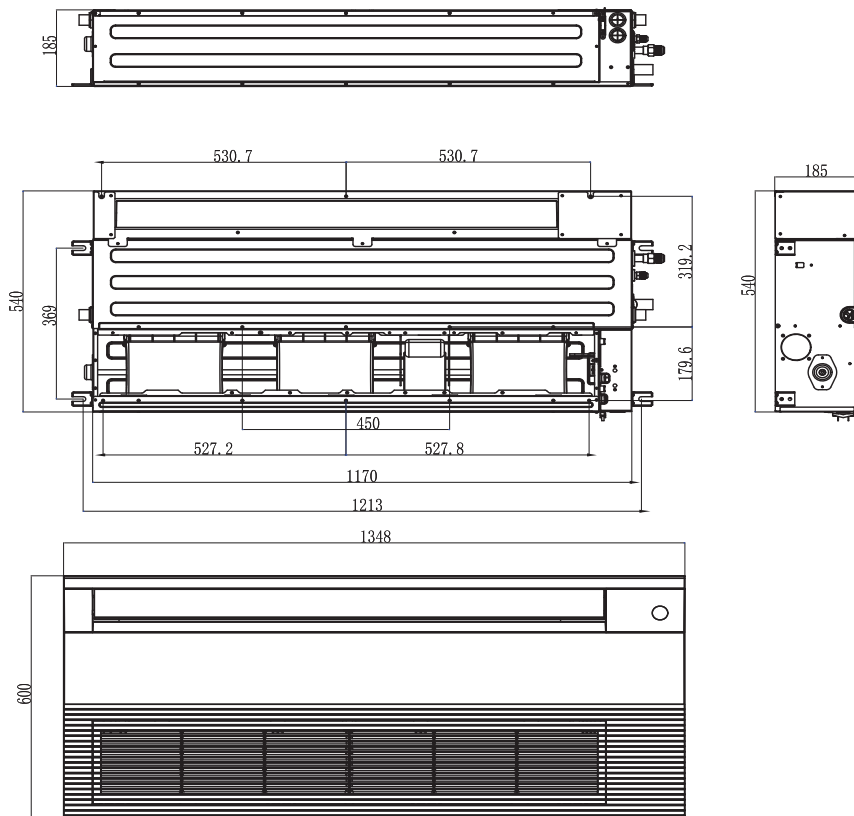

MRV INDOOR UNIT 2-WAY CASSETTE

AB**2MBERAD

AB**2MBFRA

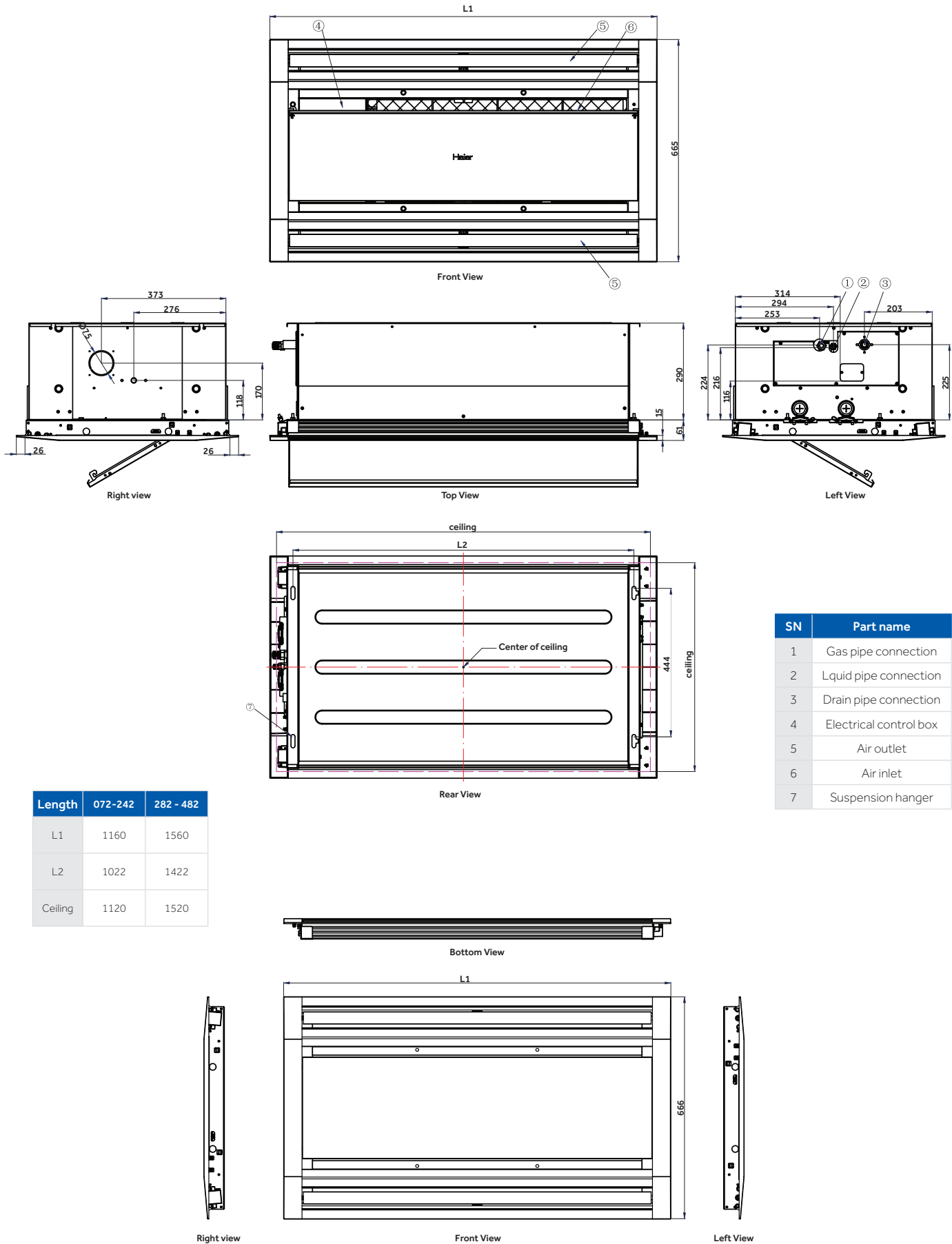

Length	072-242	282 - 482
L1	1160	1560
L2	1022	1422
Ceiling	1120	1520

SN	Part name
1	Gas pipe connection
2	Liquid pipe connection
3	Drain pipe connection
4	Electrical control box
5	Air outlet
6	Air inlet
7	Suspension hanger

CEILING-FLOOR CONVERTIBLE (AC092 - AC182)

AC**2MDERA

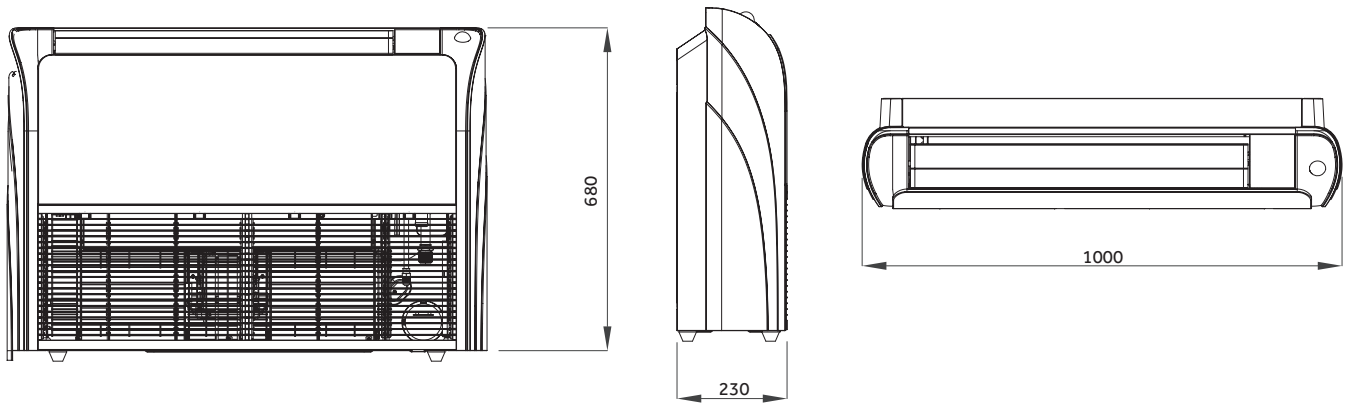

CEILING-FLOOR CONVERTIBLE (AC242 - AC302)

AC**2MDERA

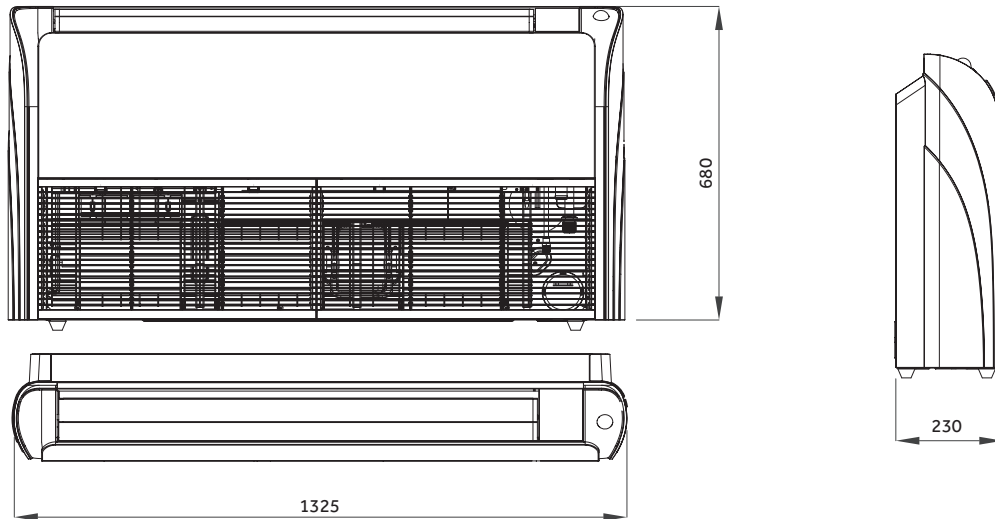

CEILING-FLOOR CONVERTIBLE (AC382 - AC482)

AC**2MDERA

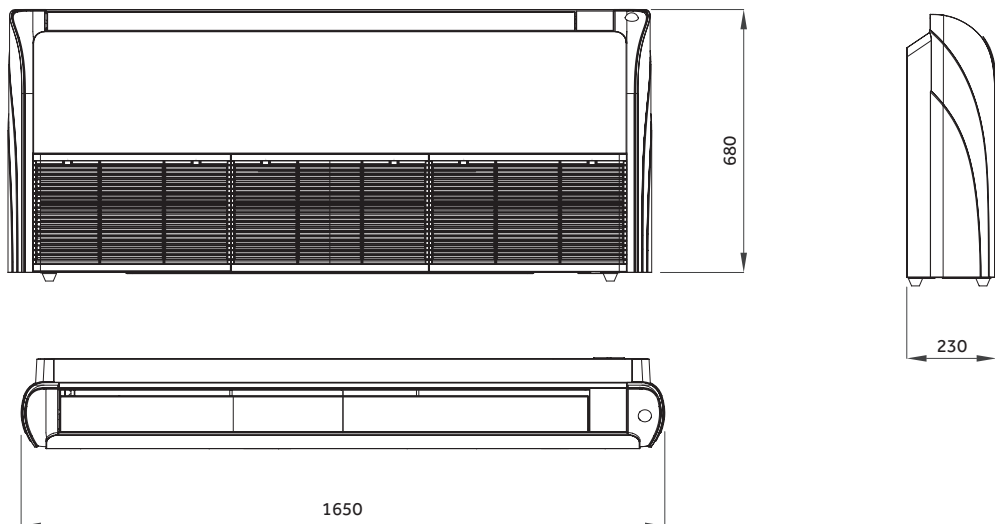

MRV INDOOR UNIT FLOOR CONSOLE

AF**2MBERA AF**2MBFRA

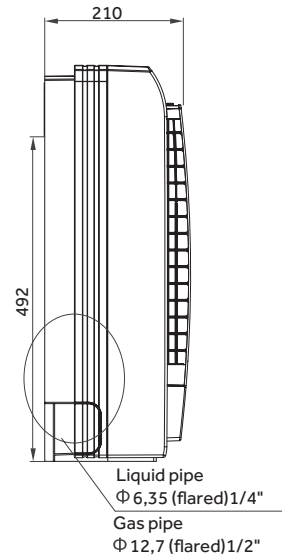
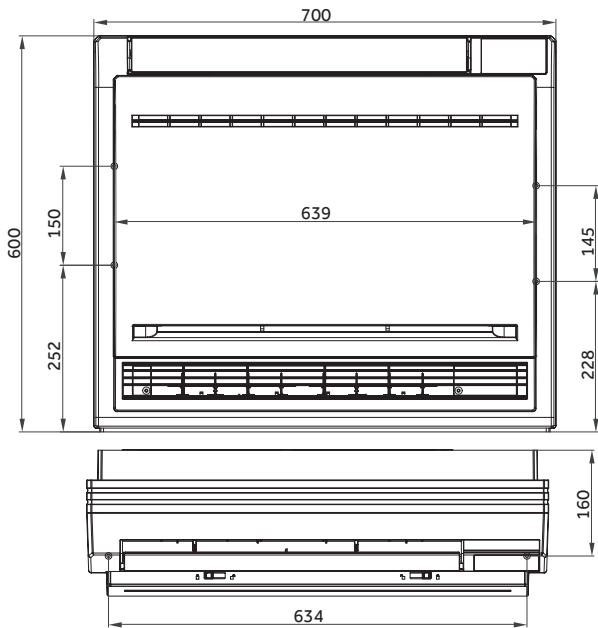

MRV INDOOR UNIT SLIM DUCT LOW PRESSURE (15/30PA)

AD**2MSERA(H)

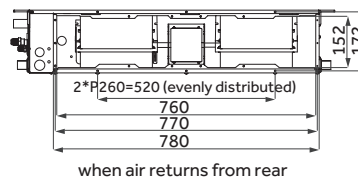
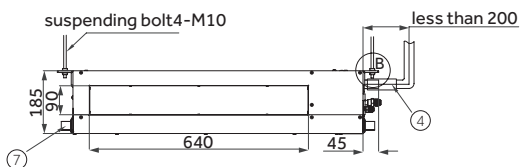
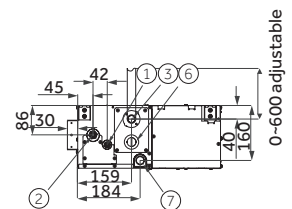
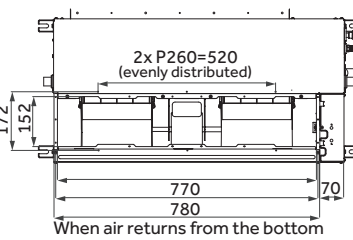
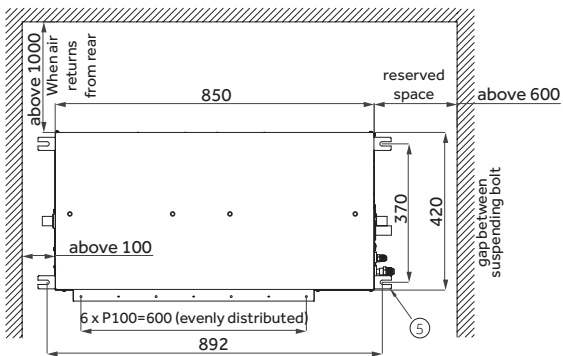

SN	Part name
1	Liquid pipe connection
2	Gas pipe connection
3	Drain hose the pump
4	Drain hose (accessory)
5	Suspending point
6	Checking hole
7	Water drainage outley

MRV INDOOR UNIT SLIM DUCTED LOW PRESSURE (0/40Pa)

AD**2MSFRA
AD**2MSFRAC

SN	Part name
1	Gas pipe connection
2	Liquid pipe connection
3	Drain pipe connection
4	Drain hose
5	Fresh Air inlet

Unit: mm

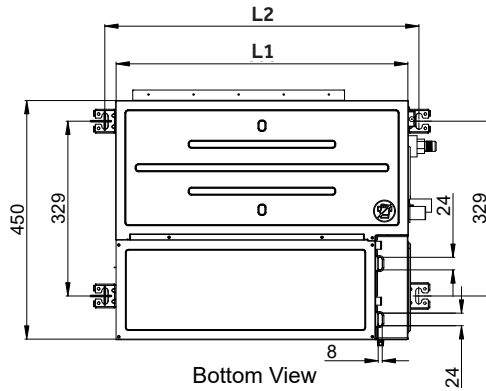

Length	L1	L2
AD042 - AD092	550	592
AD122 - AD162	700	742
AD182	900	942
AD242	1100	1142

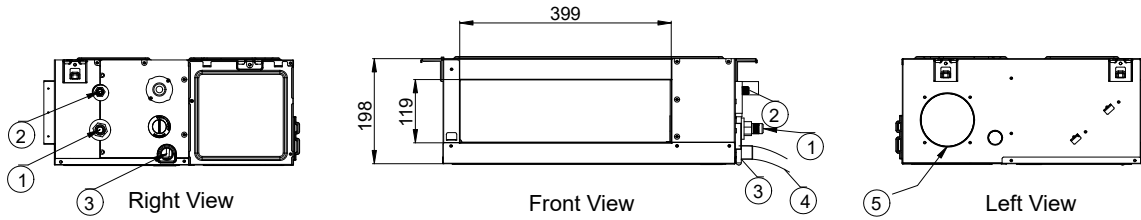

MRV INDOOR UNIT COMPACT DUCTED LOW - MED (50/90Pa)

AD**2MSFRAM

SN	Part name
1	Gas pipe connection
2	Liquid pipe connection
3	Drain pipe connection
4	Drain hose
5	Fresh Air inlet

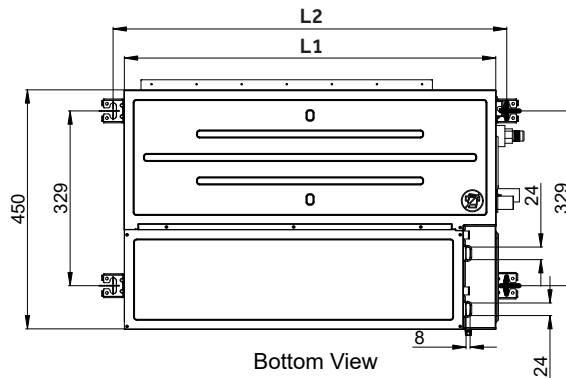

Length	L1	L2
AD042 - AD092	700	742
AD122	900	942
AD162 - AD182	1100	1142

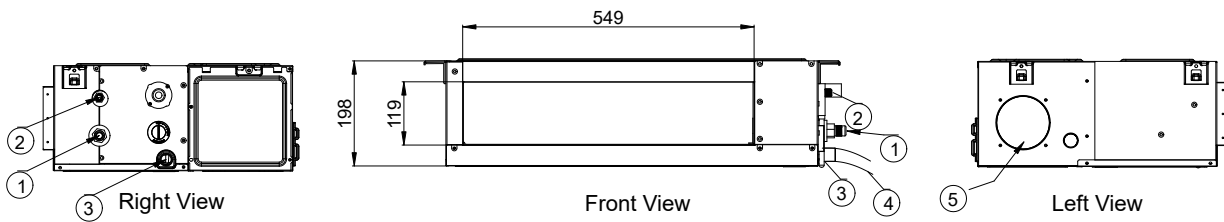

MRV INDOOR UNIT DUCTED HIGH PRESSURE

AD**2MTERAD

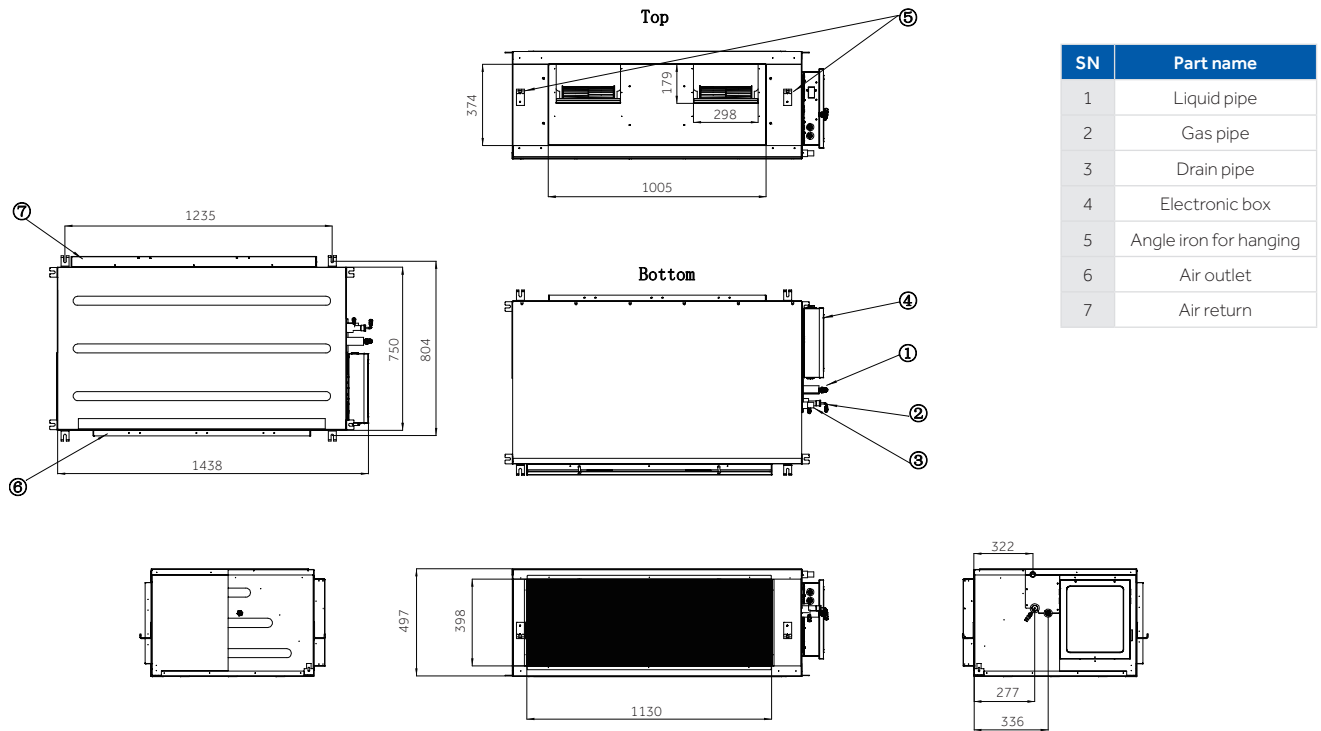

UNIT INTERNAL FLOOR CONSOLE, BUILT-IN

AE**2MLERA

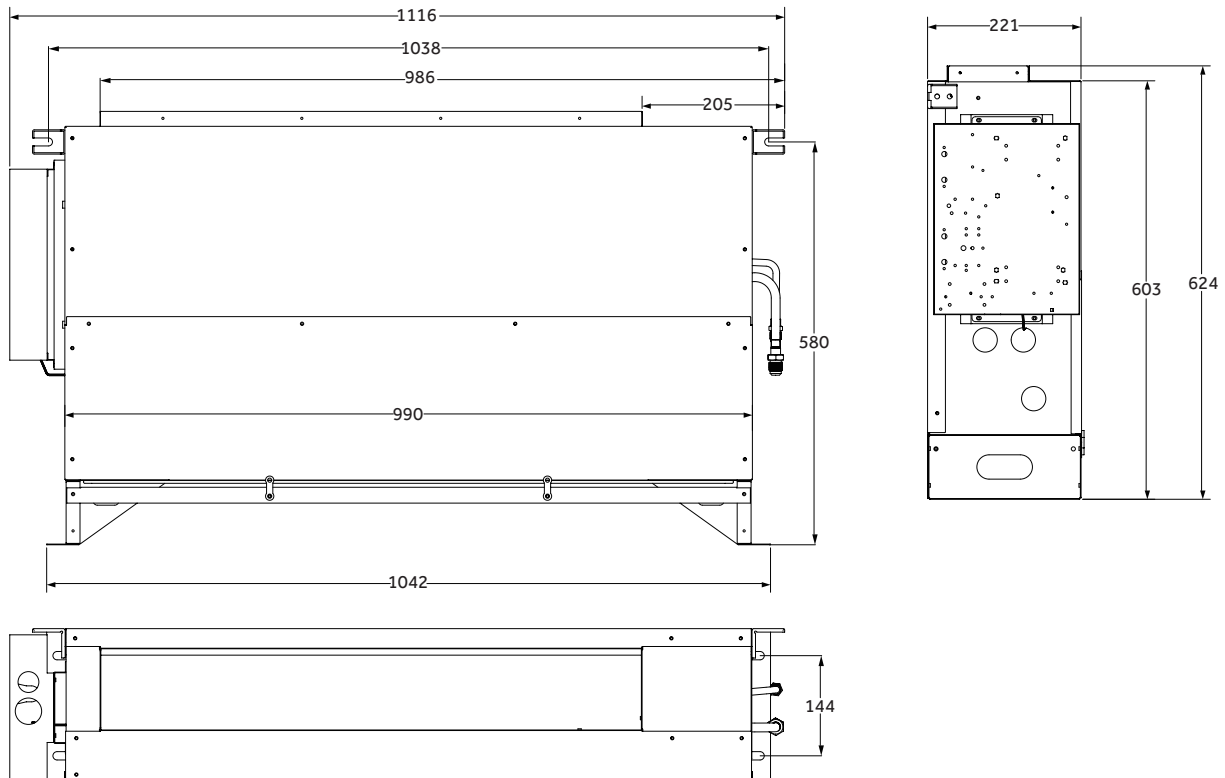

SOLDER JOINTS TO CREATE COOLING CIRCUITS

JOINTS FOR 3-PIPE CIRCUIT - INDOOR UNIT SIDE

Measurements in millimetres ID - inner diameter / OD - outer diameter

All accessories in
below table use:

Model	Gas Side Joint Recovery/Return	Gas Side Joint High Pressure	Liquid Side Joint	Adapters side Gas Recovery/Return included in the kit	Adapters Side Gas High Pressure included in the kit	Adapters Side Liquid included in the kit	Applicable Power in kW (total sum of the nominal cooling powers of the indoor units to be powered downstream of the joint)
FGG-R335A							Up to 33,5
FGG-R506A							33,5 to 50,6
FGG-R730A							50,6 to 73,0
FGG-R1350A							73,0 to 135,0
FGG-R2040A							Over 135,0

The data in this catalogue is purely indicative as the data may vary. Please be advised to check the accuracy of the data with the supplier before purchasing products.

COLLECTORS FOR 2-PIPE CIRCUIT ON THE SIDE OF INDOOR UNITS

Model	Pipes	Branch	Adapter, Included in the kit	Applicable power in kW (total sum of the nominal cooling powers of the indoor units connected to the collector)
FQG-H3704	Gas			up to 30 total (sum of all outputs) If you need to connect indoor units with power exceeding 5,6 kW, you must use model FQG-H3705 with more than 5 outputs for pipe diameter requirements
	Liquid			
FQG-H3705	Gas			up to 30 total (sum of all outputs)
	Liquid			
FQG-H3708_35kW	Gas			up to 35 total (sum of all outputs)
	Liquid			
FQG-H3708_70kW	Gas			up to 70 total (sum of all outputs)
	Liquid			

Diameters in inches (")											
1	6,35 mm	1/4"	5	19,05 mm	3/4"	9	31,75 mm	1"1/4	13	44,45 mm	1"3/4
2	9,52 mm	3/8"	6	22,40 mm	7/8"	10	34,92 mm	1"3/8	14	50,80 mm	2"
3	12,70 mm	1/2"	7	25,40 mm	1"	11	38,10 mm	1"1/2			
4	15,88 mm	5/8"	8	28,57 mm	1"1/8	12	41,28 mm	1"5/8			

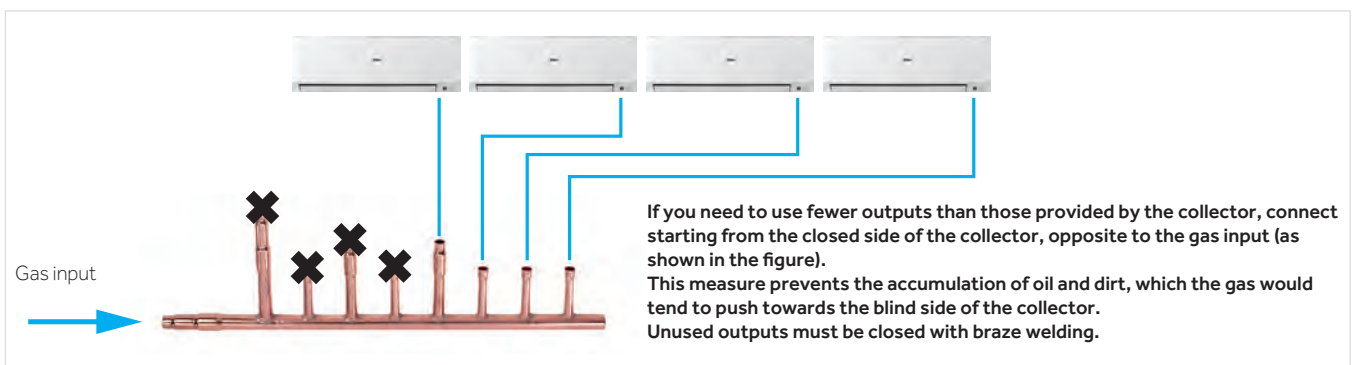

SOLDER JOINTS TO CREATE COOLING CIRCUITS

JOINTS TO COMBINE OUTDOOR UNITS WITH 2 TUBES.

Measurements in millimetres ID - inner diameter / OD - outer diameter

HZG-20B - kit to be provided to combine 2 modules

Model	Pipes	ID	Branch	Gas Side Adapters Recovery/Return included in the kit
HZG-20B	Gas Side Joint	A		
	Liquid Side Joint	B		

HZG-30B - kit to be provided to combine 3 modules

Model	Pipes	ID	Branch	Gas Side Adapters Recovery/Return included in the kit
HZG-30B	Gas Side Joint	C		
		D		
	Liquid Side Joint	E		
		F		

JOINTS TO COMBINE OUTDOOR UNITS WITH 3 HEAT RECOVERY TUBES

Measurements in millimetres ID - inner diameter / OD - outer diameter

HZG-R20B - kit to be provided to combine 2 modules

Model	Pipes	ID	Branch
HZG-R20B	Gas Side Joint Recovery/ Return	A	
	Gas High Pressure Side Joint	B	
	Liquid Side Joint	C	

JOINTS TO COMBINE OUTDOOR UNITS WITH 3 HEAT RECOVERY TUBES

Measurements in millimetres ID - inner diameter / OD - outer diameter

HZG-R40B – kit to be provided to combine 4 modules

Model	Pipes	ID	Branch	Gas Side Adapters Recovery/Return included in the kit
HZG-R40B	Joint side Liquid	P		
		Q		
		R		



MRV AHU

Applications



MRV AHU

INTRODUCTION & BENEFITS

APPLICATIONS

Regulations require adequate air renewal in the premises according to the activity carried out inside the building. Thanks to the interface kit between high efficiency MRV units and direct expansion air treatment units, Haier is able to meet the needs for air renewal and treatment.



GENERIC CONNECTION SCHEME

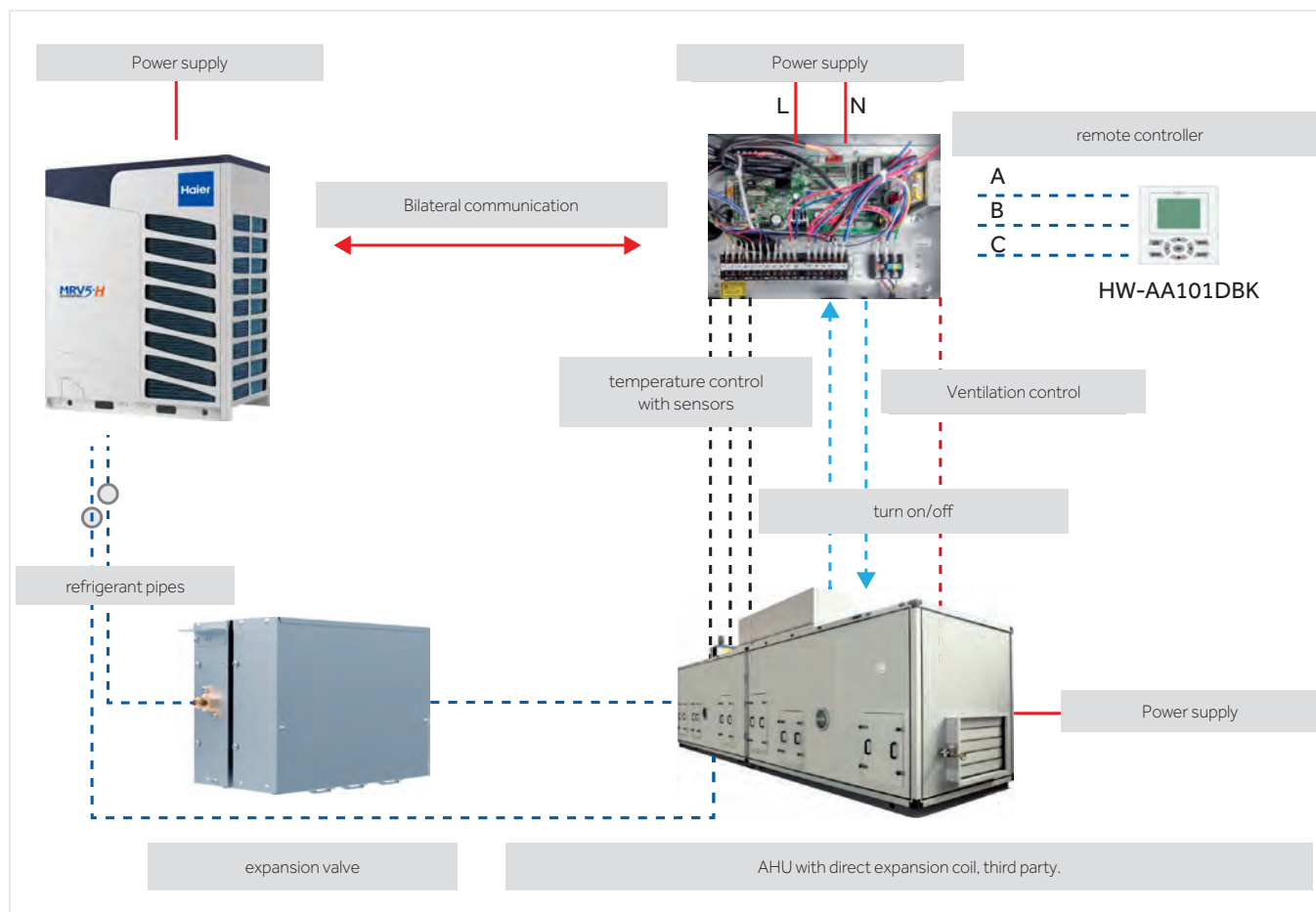





MRV AHU

CONNECTABLE OUTDOOR UNITS

Valve box	 <p>MRV-S</p>	 <p>MRV5-H</p>
<p>AH1-070B - AH1-140B - AH1-280B</p> <p>Valve box</p>  <p>1HP (3,5kW) <AHU connection capacity ≤10HP (28,0kW)</p>		<p>AH1-280B - AH1-560B - AH1-730B</p>  <p>10HP (28,0kW) <AHU connection capacity ≤26HP (73,0kW)</p>
<p>AHU</p>  <p>Third-party AHU</p>		

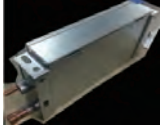
CONTENTS OF THE AHU KIT

AH1-070B
 AH1-140B
 AH1-280B

=  Refrigerant expansion valve included
 +  Control electronics included
 +  Temperature sensors and wiring included
 +  HW-AA101DBK wired touch screen remote control included

AH1-560B
 AH1-730B

=  Refrigerant expansion valve included
 +  Control electronics included
 +  Temperature sensors and wiring included
 +  HW-AA101DBK wired touch screen remote control included

MRV AHU

CONTROL AND MANAGEMENT SYSTEMS

A Haier MRV-AHU system is comparable to a classic VRF system, therefore it can be inserted in a group control context.

Example

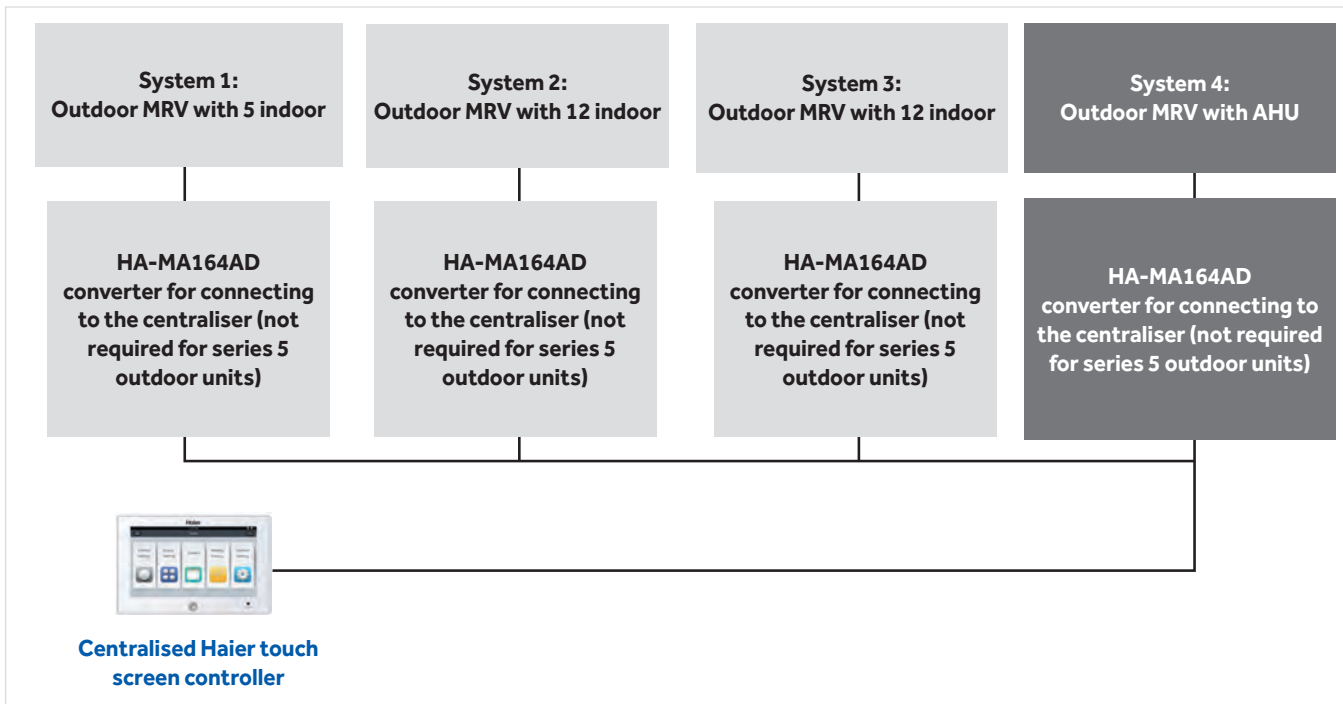

SIMPLE INSTALLATION

Compared to a traditional water system, Haier's AHU-MRV direct-expansion technology minimises plant components. No cooling towers, large water pipes or pumps are needed. In addition, the efficiency of MRV/VRF/VRV systems is notoriously higher than traditional air/water systems. Haier AHU-MRV systems can be independently or centrally controlled thanks to Haier's multiple solutions for product control and management. It is also possible to power MRV and AHU indoor units within the same plant.

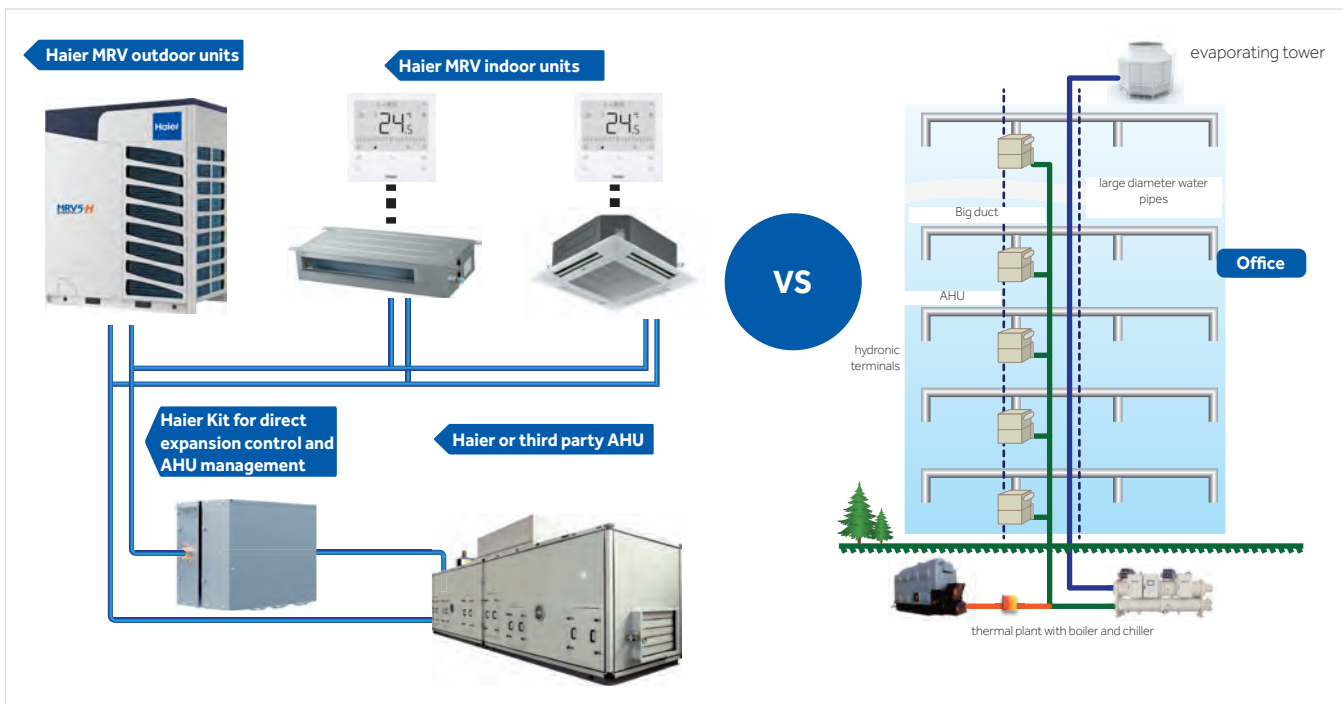

MRV AHU

CHARACTERISTICS AND FUNCTIONS

- Ability to control third-party AHU
- Compatible with MRV 5-series outdoor units and MRV SII series" (4-12 HP)
- A single box covers a power range of 3,5 to 73,0 kW. Can to connect up to 3 boxes in parallel for large capacity.
- Expansion valve and paired electronic boards, with separation possibilities for greater flexibility during installation.
- Managing 0-10 V DDC inbound signal from third-party controller
- Temperature signal control provided by a DDC control or return from the Haier sensor
- Remote contact input to select Hot/Cold mode
- Clean contact input for managing 3 ventilation speeds
- Status signal output "Defrost / Defrost"

TECHNICAL SPECIFICATIONS





AH1-070B
AH1-140B
AH1-280B



AH1-560B
AH1-730B

Model		AH1-070B	AH1-140B	AH1-280B	AH1-560B	AH1-730B
Connectable capacity (kW AHU intertial exchanger)	kW	3,5≤X≤7,0kW (1-3HP)	7,0≤X≤14,0kW (3-5HP)	14,0≤X≤28,0kW (5-10HP)	28,0≤X≤56,0kW (10-20HP)	56,0≤X≤73,0kW (20-26HP)
Power supply	V-Ph-Hz	220-230-1-50/60	220-230-1-50/60	220-230-1-50/60	220-230-1-50/60	220-230-1-50/60
Unit Dimensions WxDxH	mm	420x260x165	420x260x165	420x260x165	420x260x215	420x260x215
Packaged unit dimensions WxDxH	mm	520x340x225	520x340x225	520x340x225	520x340x275	520x340x275
Net weight / Gross weight	Kg	5,5 / 8,5	5,5 / 8,5	5,5 / 8,5	6,5 / 10,0	6,5 / 10,0
Material		Galvanised sheet				
Colour		Grey	Grey	Grey	Grey	Grey
Liquid pipe diameter (input/output to AHU)	mm (inch)	9,52 (3/8) / 6,35 (1/4)	9,52 (3/8) / 6,35 (1/4)	9,52 (3/8) / 6,35 (1/4)	12,70 (1/2) / 15,88 (5/8)	12,70 (1/2) / 15,88 (5/8)
Connection method		Flare	Flare	Flare	Flare	Flare
Maximum distance between BOX and AHU	m	5	5	5	5	5
Maximum height difference between BOX and AHU	m	5	5	5	5	5

ADVANTAGES

Valve capacity	Possibility to control AHU with power values from 3 to 73 kW with a single valve
High compatibility	The same electronic boards as the MRV indoor units for simple management and maintenance
Reliability	<p style="text-align: center;">The expansion valve is produced by FUJIKOKI, the Japanese leader in this sector.</p> <div style="display: flex; justify-content: space-around; align-items: center;">   </div>

Control method "A"

The third-party control system generates a signal ranging from 0-10 V to represent the required power demand. Haier's AHU Kit uses this input signal to adjust the power delivered by the MRV unit to meet the real need for thermal air treatment.

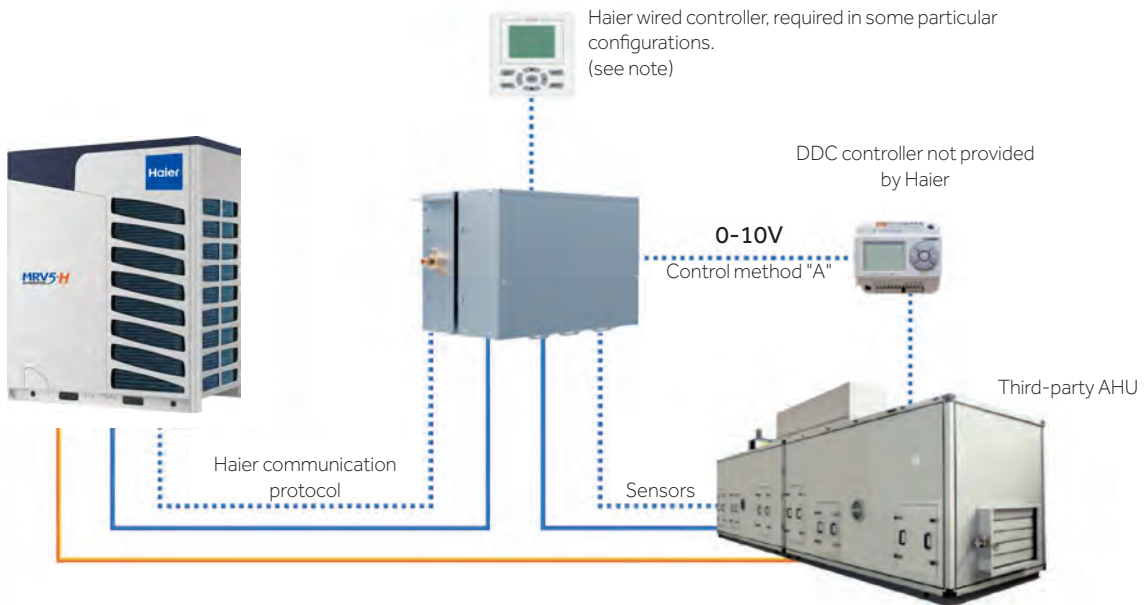

Liquid/Gas refrigerant pipes, only the liquid pipe enters the valve box and then continues to the direct expansion coil. The Gas pipe goes directly from the outdoor unit to the coil inside the AHU.

Note:

If the third-party DDC controller generates only the 0-10 V demand indicator signal, the Haier wired controller is necessary to handle the following signals: Hot/cold operating mode, switching AHU on/off, alarms.
If the DDC controller generates all the necessary signals, the Haier controller is not required.

Control method "B"

The temperature is controlled by the third-party DDC, which sends the 0-10 V modulating signal to the Haier kit that will control the temperature set point.

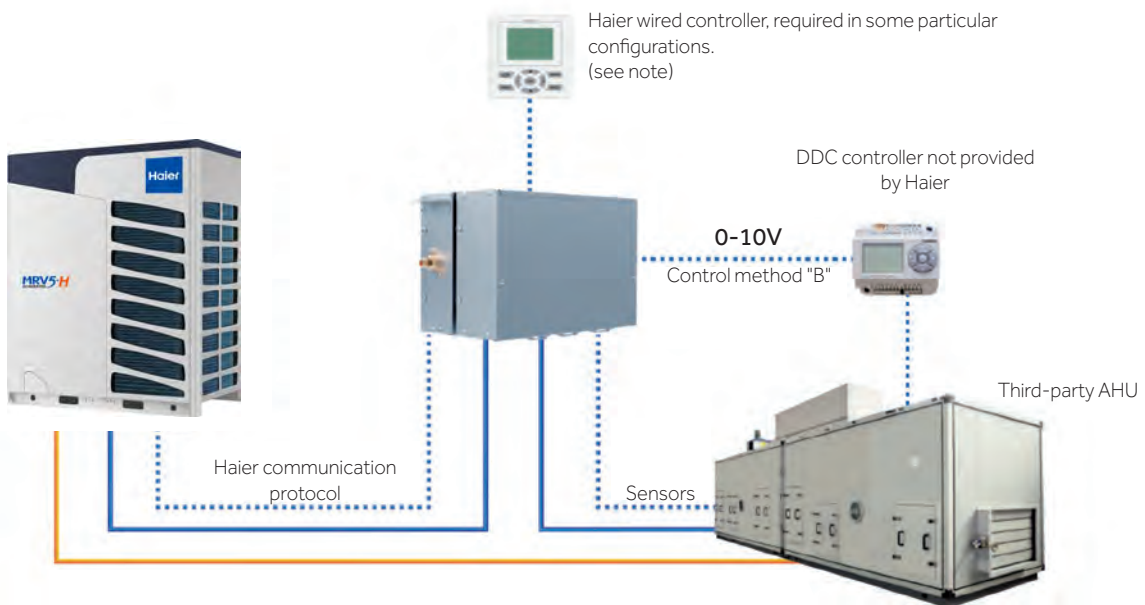

Liquid/Gas refrigerant pipes, only the liquid pipe enters the valve box and then continues to the direct expansion coil. The Gas pipe goes directly from the outdoor unit to the coil inside the AHU.

Note:

If the third-party DDC controller only generates the 0-10 V signal corresponding to the required temperature set point, the Haier wired controller is necessary to handle the following signals: Hot/cold operating mode, switching AHU on/off, alarms. If the DDC controller generates all the necessary signals, the Haier controller is not required.

Control method "C", special applications

Configuring the system WITHOUT a third-party DDC. In this case, the Haier controller is necessary to make all the settings. This system requires the installation of an on/off thermostat that switches on or off the AHU when the temperature set point is reached. This "C" method is used to continuously heat or cool in an on/off manner, without modulation and therefore with less comfort in the environments.

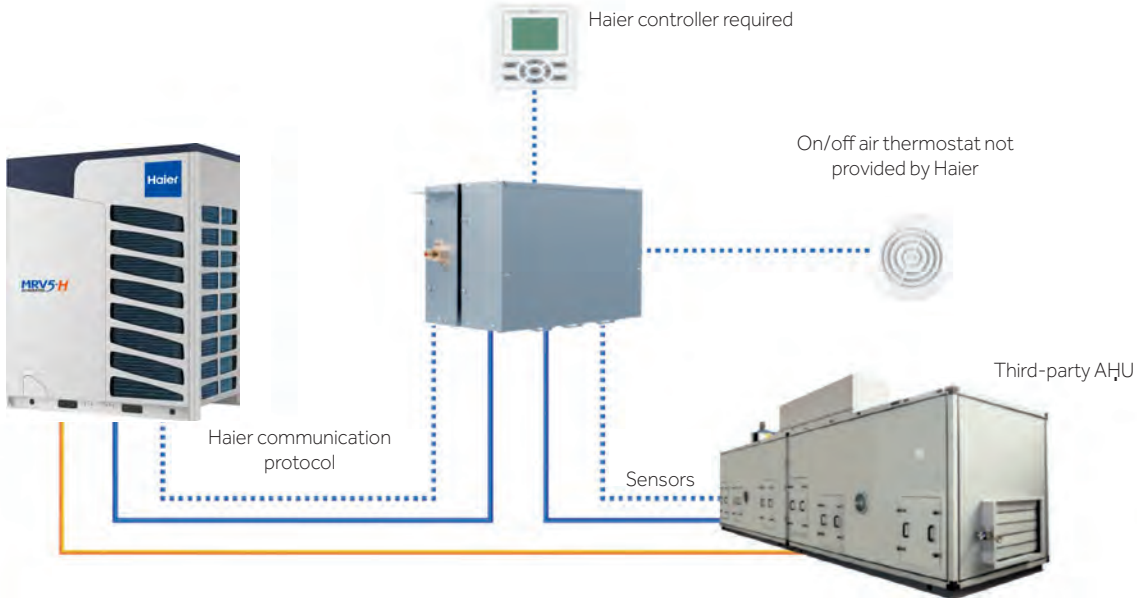

Liquid/Gas refrigerant pipes, only the liquid pipe enters the valve box and then continues to the direct expansion coil. The Gas pipe goes directly from the outdoor unit to the coil inside the AHU.

Control method "D"

MRV and AHU mixed air conditioning system work in the same cooling circuit with MRV Haier and third-party AHU indoor unit. In this case Haier controller is required.

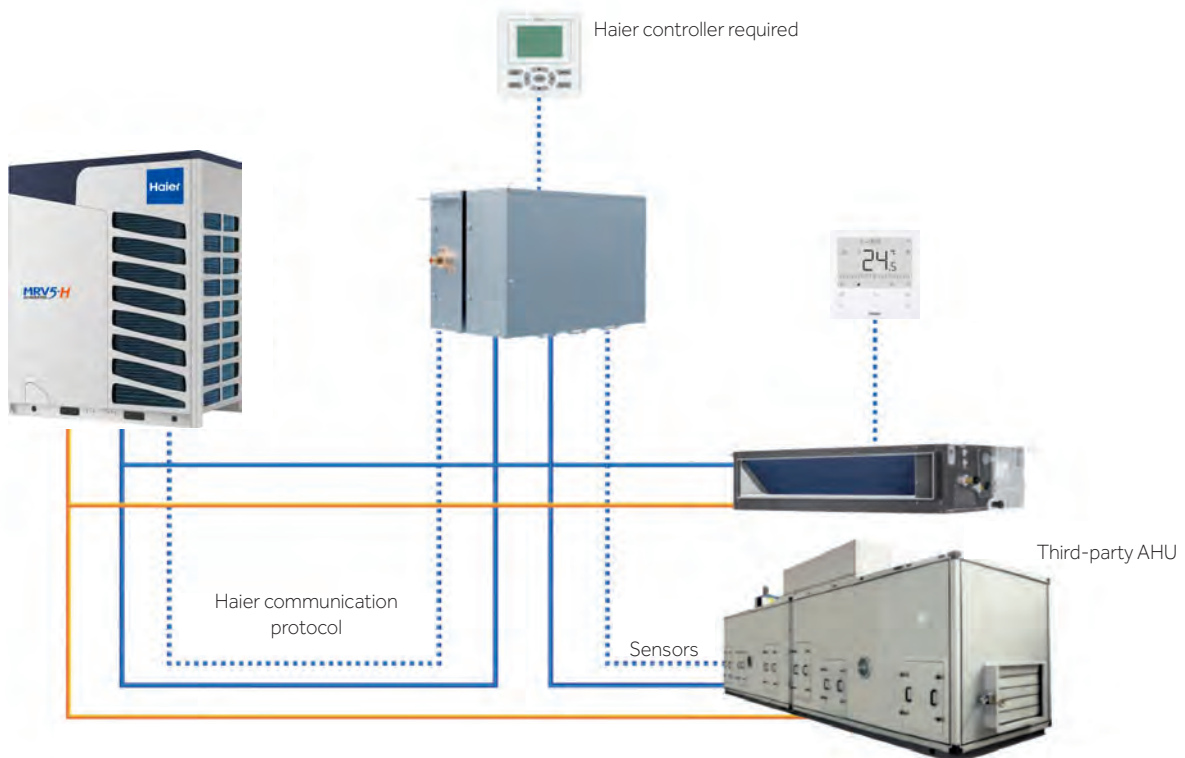

Liquid/Gas refrigerant pipes, only the liquid pipe enters the valve box and then continues to the direct expansion coil. The Gas pipe goes directly from the outdoor unit to the coil inside the AHU.



Control & Management Systems

SIMPLE AND INTUITIVE SOLUTIONS TO MANAGE PLANTS

A SINGLE INTEGRATED SYSTEM

Haier's communication protocol is unique to MRV systems and the residential and commercial products of the Supermatch line. This allows the same controls to be used for both small and large MRV plants.

MANAGEMENT AND SUPERVISION

Haier provides reliable and professional supervision systems for better management of preventive maintenance as well.

"SMART" CONTROLS

Systems that can be customised to meet your needs.



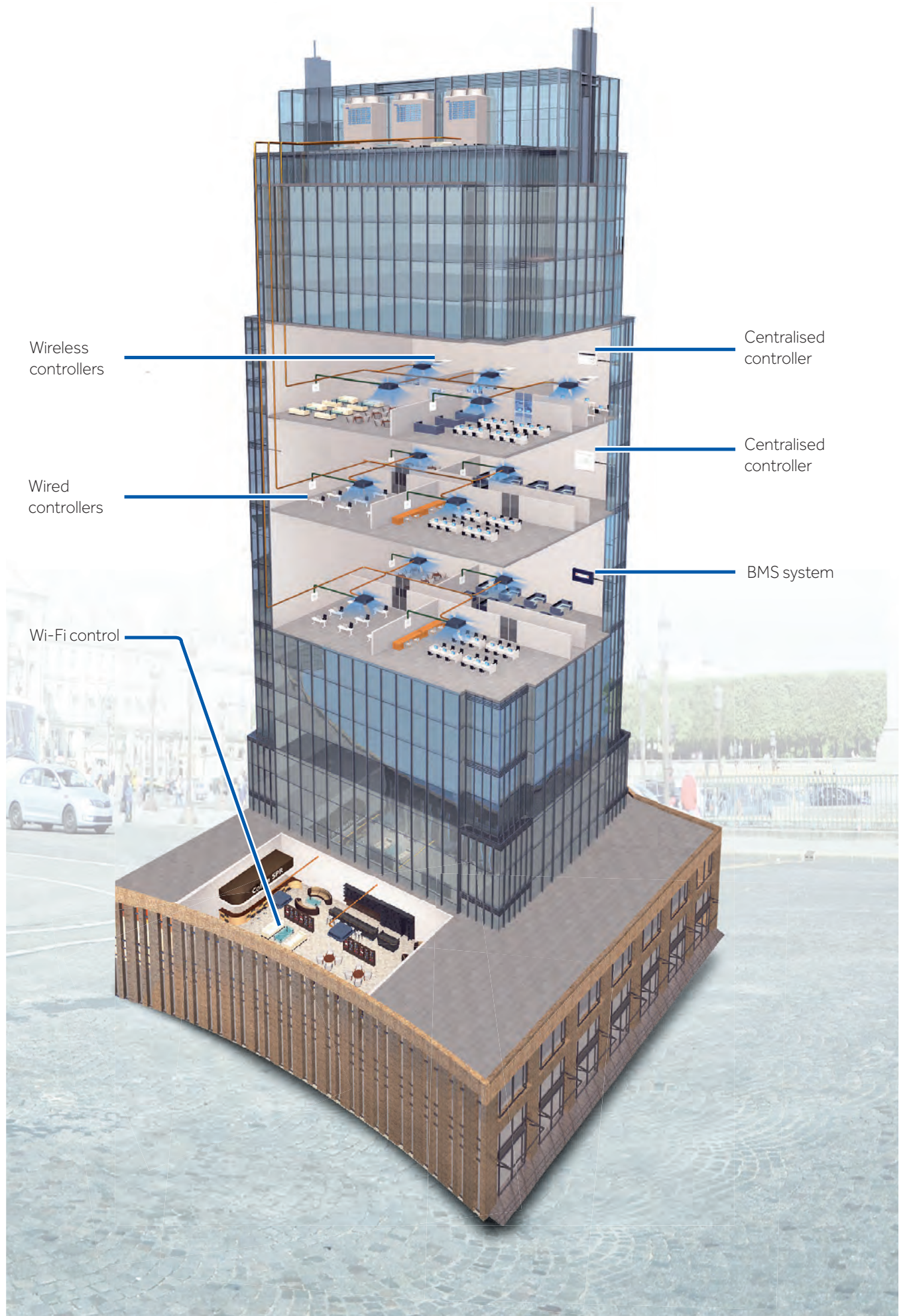

CENTRALISED CONTROL

The centralised controls provide a customised control of the entire system from a single point. Manage individual units, groups, or zones and define different settings for each of them.

5" **HC-SA164DBT**
UP TO 64 INDOOR UNITS



7" **YCZ-A004**
UP TO 256 INDOOR UNITS



12,5" **HC-LA1CDBT**
UP TO 800 INDOOR UNITS

MULTI-LANGUAGE

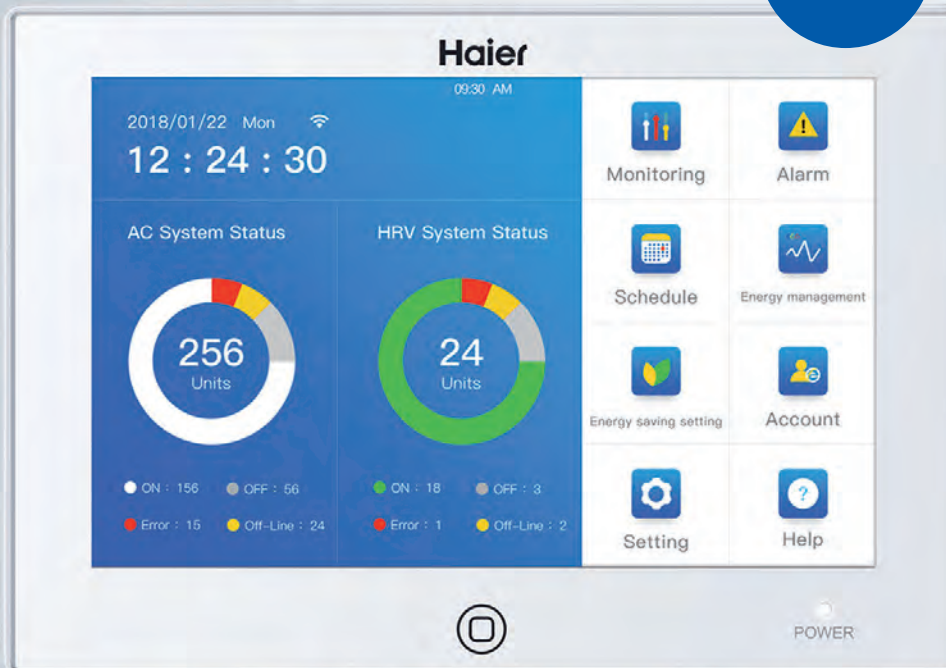

HC-SA164DBT

- Possibility to control via WEB/Internet by means of optional Wi-Fi module HI-WA164DBI
- Intelligent system for plants up to 64 indoor units
- 5" LCD TFT full touchscreen display backlit
- Built-in weekly timer
- Possibility of naming units and groups
- Displaying alarms
- Requires HA-MA164AD except when connected directly to MRV5 versions or MRV S II (AU**NFKERA) – for details see following pages
- 32 independent cooling circuits, each with their own HA-MA164AD converter
- Ability to simultaneously control MRV units and Split units Supermatch / Residential.
- MODBUS output as standard

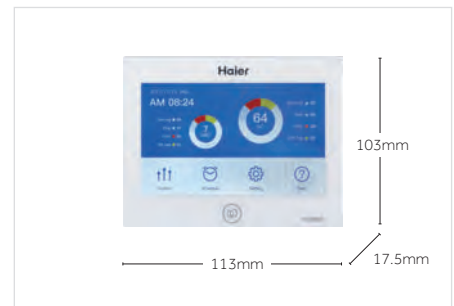

YCZ-A004

- Smart system for medium size plants up to 256 indoor units
- Large 7" LCD TFT full touchscreen display
- Built-in weekly timer
- Possibility of naming units and groups
- Displaying alarms
- Requires HA-MA164AD except when connected directly to MRV5 versions or MRV S II (AU**NFKERA) – for details see following pages
- 32 independent cooling circuits, each with their own HA-MA164AD converter
- **You cannot control MRV units and Supermatch/Residential with the same controller**
- MODBUS output as standard



HC-LA1CDBT

- 12.5-inch TFT LCD touch screen
- Max. 800 MRV indoor units and Max. 128 LCAC IDUs connectable for one controller (totally 928) IDUS connectable
- Floor plan layout view
- Web Access and Email Alarm
- Weekly Schedule and Special day setting
- Integrate 3rd party devices like fire alarm, lighting with Haier indoor units
- All MRV system requires the gateway HA-MA1ADB(One system requires one gateway)
- LCAC products requires PCB adapter YCJ-A002(One IDU requires one YCJ-A002)
- Total electricity consumption display and consumption distribution for tenant billing (the amp meter would need to be connected to HA-MA1ADB)
- Data curve

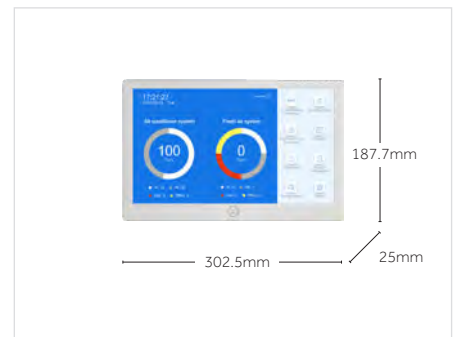

HA-MA164AD

- Haier protocol converter to RS-485
- To be connected to centralised systems (not required for series 5 outdoor units)
- Each cooling circuit needs 1 converter
- 1 converter can handle max 64 internal units on single cooling circuit
- This accessory, if NOT connected to a centralised controller as a dedicated converter, can be used individually to transform the communication protocol "Homebus Haier" into "MODBUS". (For this feature, configure the selectors in the desired mode)

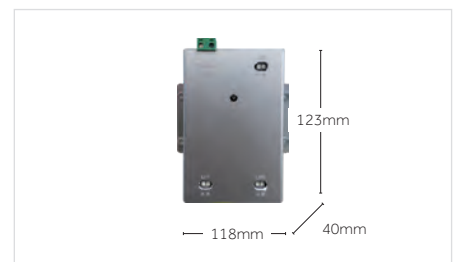

HA-MA1ADB

- Interface: Modbus
- Match with 12.5-inch webserver central controller HC-LA1CDBT
- Max. 128 indoor units connectable
- Digital tube display Indoor quantity, gateway address, time and date
- Electricity data collection, calculation, distribution and storage

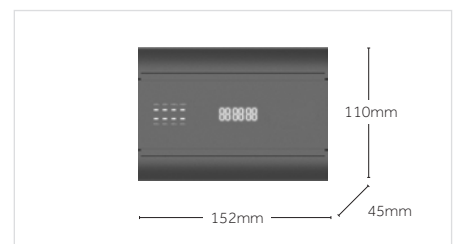

HI-WA164DBI (WI-FI MODULE)

Features:

This module, connected to an Internet access with Wi-Fi, allows remote control via dedicated APP on tablets and smartphones (no PC).

Each Wi-Fi module can control up to 64 indoor units.

Through the APP, the same functionality as the centraliser, connected to the MRV system, is replicated and managed.

Specifications:

- Control functions, on/off, temperature setting, timer settings, weekly, fan speed.
- Alarm monitoring function, errors, error history.
- User account management, including account registration, password change and account information modification via APP.
- Convenient sharing of the management authority. The primary account can share the management of the primary account with the secondary accounts, without re-registering the units.
- Each individual APP can handle up to 256 indoor units.
Example: 4 Wi-Fi modules with 64 Interior each, or 7 Wi-Fi modules with 36 interiors each
- If a HC-SA164DBT centralised controller is used directly, the Wi-Fi module can be connected directly to the centraliser on a dedicated terminal.
- The Wi-Fi module can be connected directly to the MRV series 5 outdoor units, or to the HA-MA164AD converter if the outdoor units are NOT series 5.

With this configuration it is possible to control the MRV system even without local centralised controllers, using only the APP installed on tablet or smartphone, by ensuring stable and fast Wi-Fi coverage to the module.

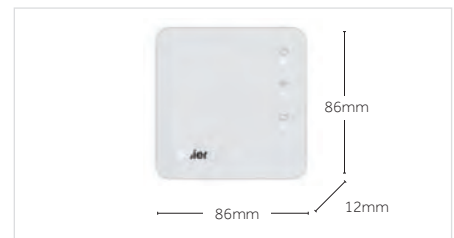

If used independently (not connected to a centralized controller) it is necessary to provide 12 DC electric supply (not provided by Haier)

HC-SA164DBT

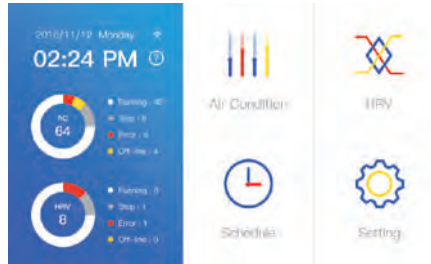

- Control of up to 64 indoor units
- Control of the operating mode, temperature, ventilation, deflectors
- Error control and alarm memory



- Daily and weekly programming for single unit
- Free and independent programming

HC-LA1CDBT



- Monitoring the status of each individual unit

HA-MA1ADB

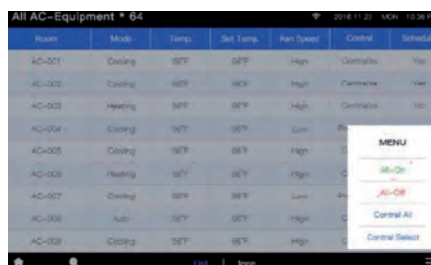

- Individual - group - total visualisation

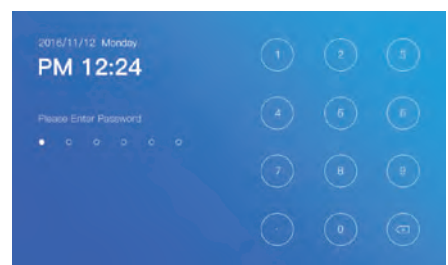

- Password setting at different levels of operation

YCZ-A004

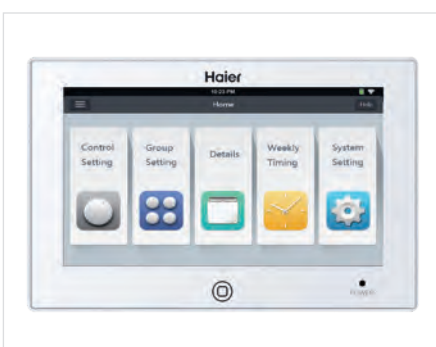

Monitoring and control

- Control of up to 256 indoor units
- Control of the operating mode, temperature, ventilation, deflectors
- Icons displayed similar to those on remote commands

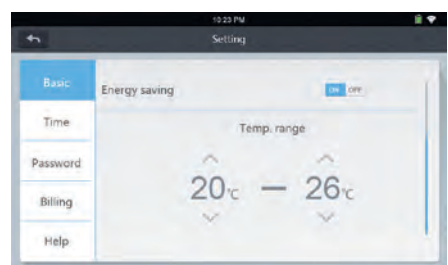

Power-saving function

- User function locking mode
- Defining lower and upper limits for desired temperature selection



Zone management

- Defining zones as per user requests



Timer programmer

- Daily and weekly programming for single unit
- Free and independent programming

WI-FI FEATURES

This module, connected to an Internet access with Wi-Fi, allows remote control via dedicated APP on tablets and smartphones (no PC). Each Wi-Fi module can control up to a maximum of 64 indoor units, which is the limit of the centraliser. Through the APP, the same functionality as the centraliser, connected to the MRV system, is replicated and managed.

SPECIFICATIONS

- It is connected to the centraliser through the cable supplied, from which it is powered.
- It can be connected up to 100 meters from the centraliser, so as to reach an area covered by Wi-Fi
- Control functions, on/off, temperature setting, timer settings, weekly, fan speed.
- Alarm monitoring function, errors, error history.
- User account management, including account registration, password change and account information modification via APP.
- Convenient sharing of the management authority. The primary account can share the management of the primary account with the secondary accounts, without re-registering the units.
- Each individual APP can handle up to 256 indoor units.
Example: 4 Wi-Fi modules with 64 Interior each, or 7 Wi-Fi modules with 36 interiors each
- The Wi-Fi module can be connected directly to the MRV series 5 outdoor units, or to the HA-MA164AD converter if the outdoor units are NOT series 5. With this system you can control the MRV system even without a centraliser installed, but through the APP alone by ensuring adequate Wi-Fi coverage to the module.
- The APP is available for Android and iOS.

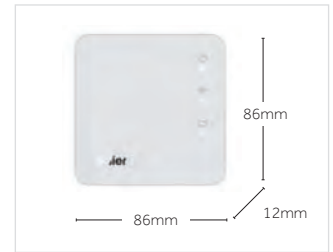

**WI-FI MODULE
HI-WA164DBI**

HAIER SMART AIR 2

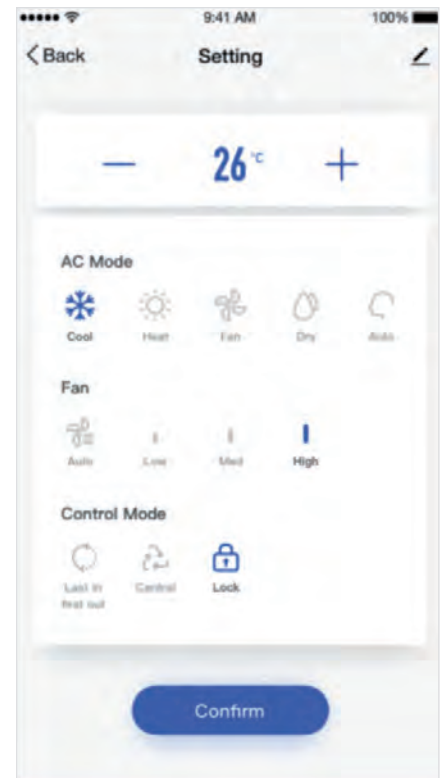
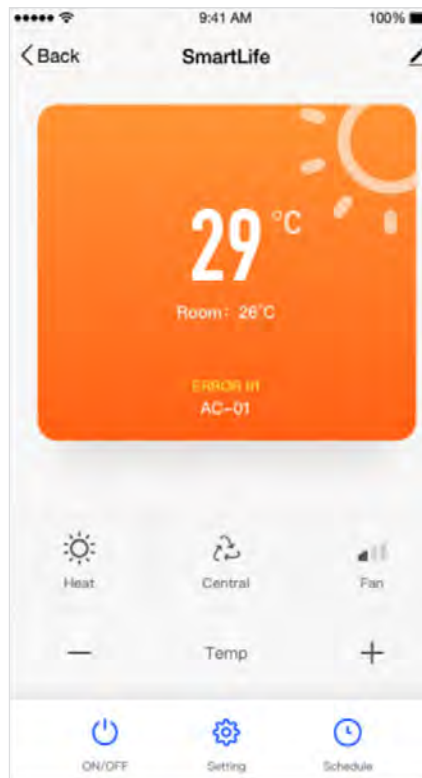

HI-WA164DBI WI-FI MODULE FOR CENTRALISED CONTROLLER HC-SA164DBT



CONFIGURATION WITH CENTRALISER

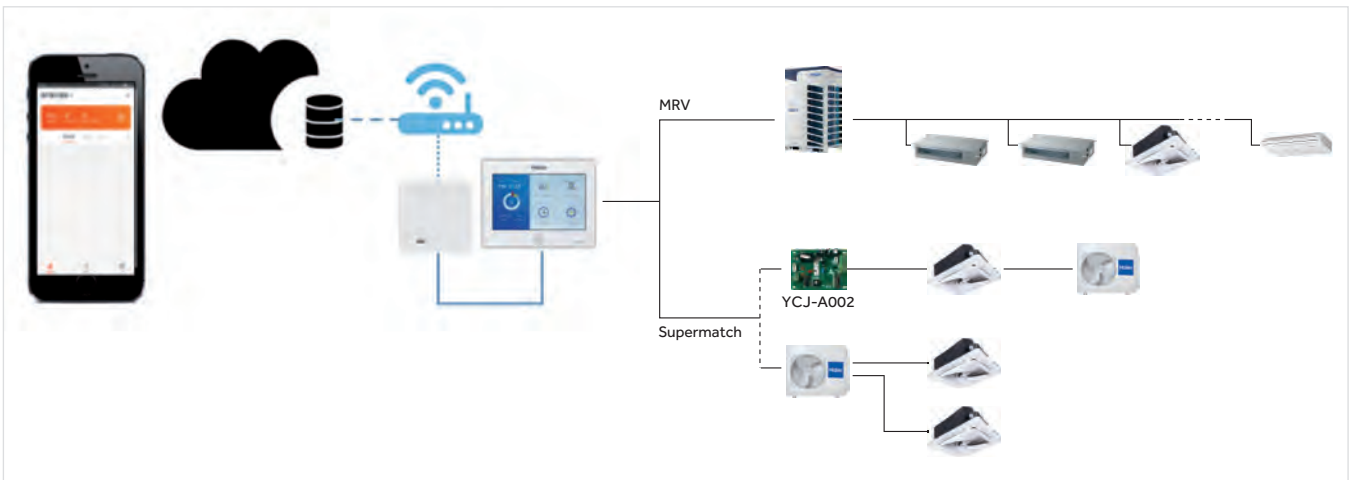

CONFIGURATION WITHOUT CENTRALISER

The Wi-Fi module can be connected directly to the MRV series 5 outdoor units, or to the HA-MA164AD converter connected to other non-series 5 MRV outdoor units. With this system you can control the MRV system even without a centraliser installed, but through the APP alone by ensuring adequate Wi-Fi coverage to the module.

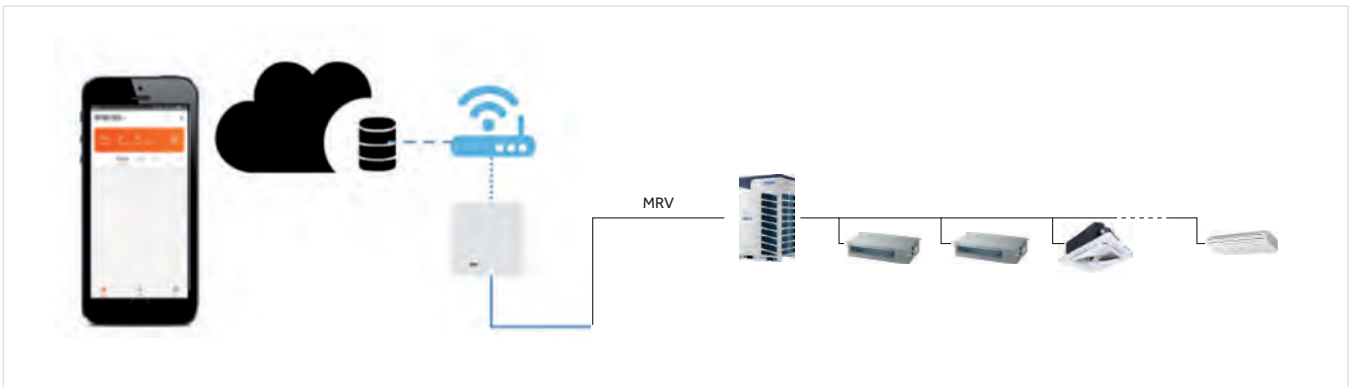

If used independently (not connected to a centralized controller) it is necessary to provide 12 DC electric supply (not provided by Haier)

EXAMPLES OF CONNECTION FOR THE "HI-WA164DBI" WI-FI MODULE ACCORDING TO THE TYPE OF SYSTEM AND THE EXPECTED PRODUCTS

Directly to the HC-SA164DBT centralised controller if provided.
The module can only be connected directly to this centralised controller.

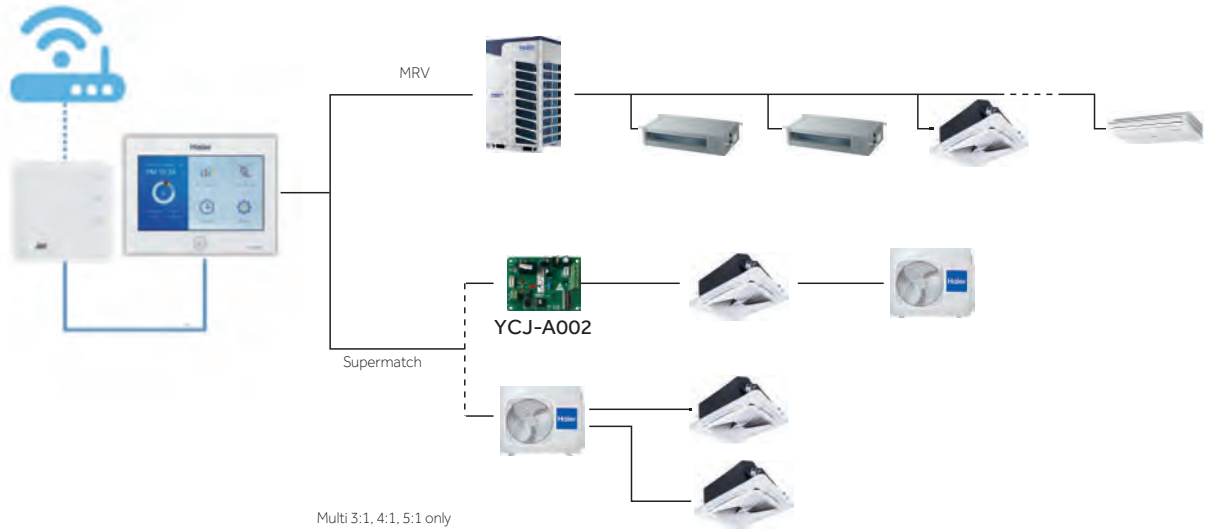

Directly to the plant; therefore, system management only via WEB / Wi-Fi
If the outdoor unit is series 5, the adaptor HA-MA164AD is not necessary.

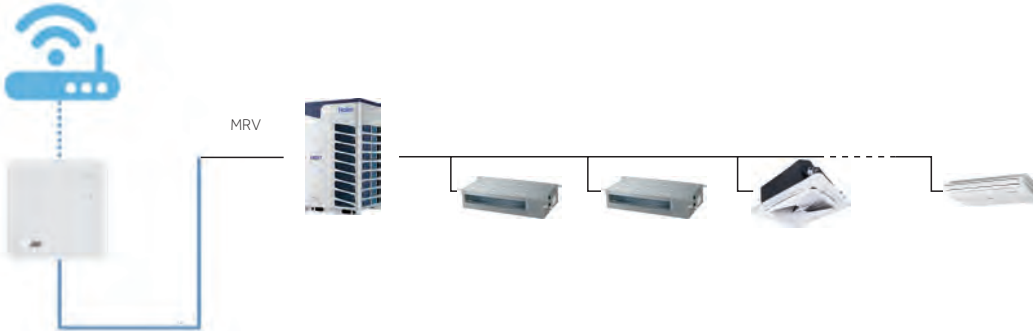

If used independently (not connected to a centralized controller) it is necessary to provide 12 DC electric supply (not provided by Haier)

Directly to the plant; therefore, system management only via WEB / Wi-Fi
If the outdoor unit is series 5, the adaptor HA-MA164AD is not necessary.

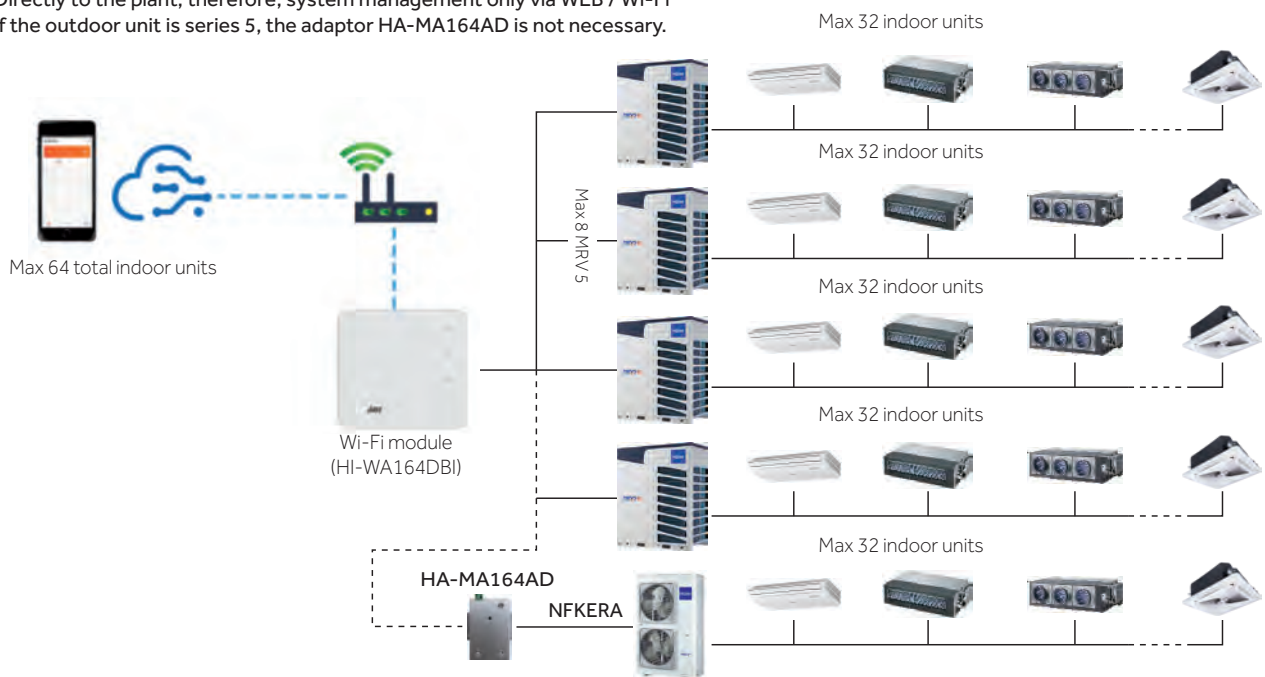

If used independently (not connected to a centralized controller) it is necessary to provide 12 DC electric supply (not provided by Haier)

If a centralised controller OTHER THAN the HC-SA164DBT model is required locally, it is necessary to add 1 HA-MA interface for each external unit

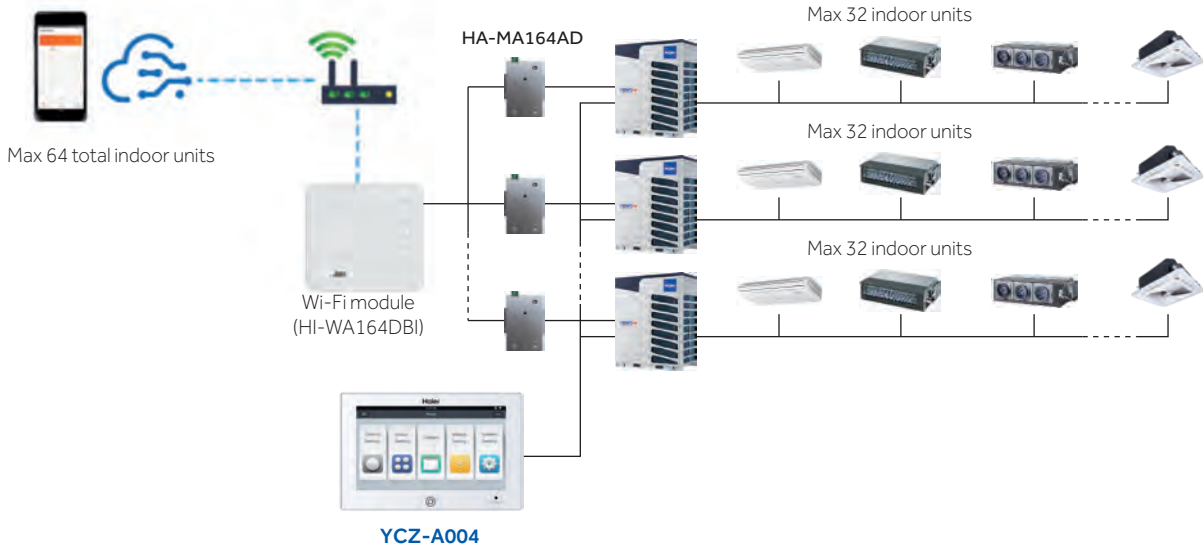

Coupled to a BMS-web or local system, always with the addition of HA-MA adapters

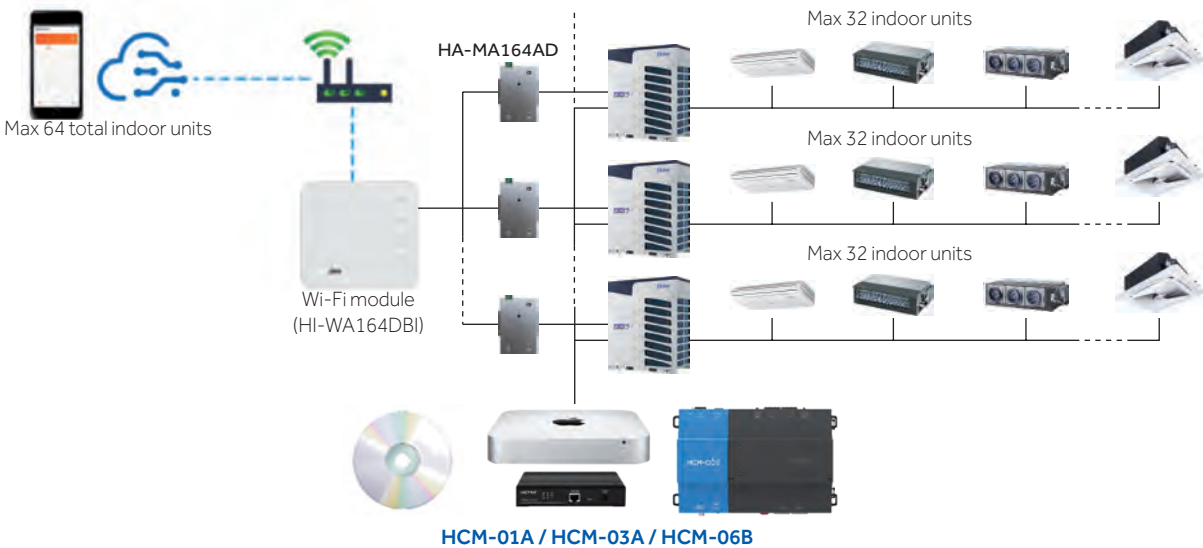

If a centralised controller is required locally and the external units are NOT 5 series, but S-series (front discharge), it is necessary to add 2 HA-MA interface for each outdoor unit, 1 for Wi-Fi and 1 for the centraliser

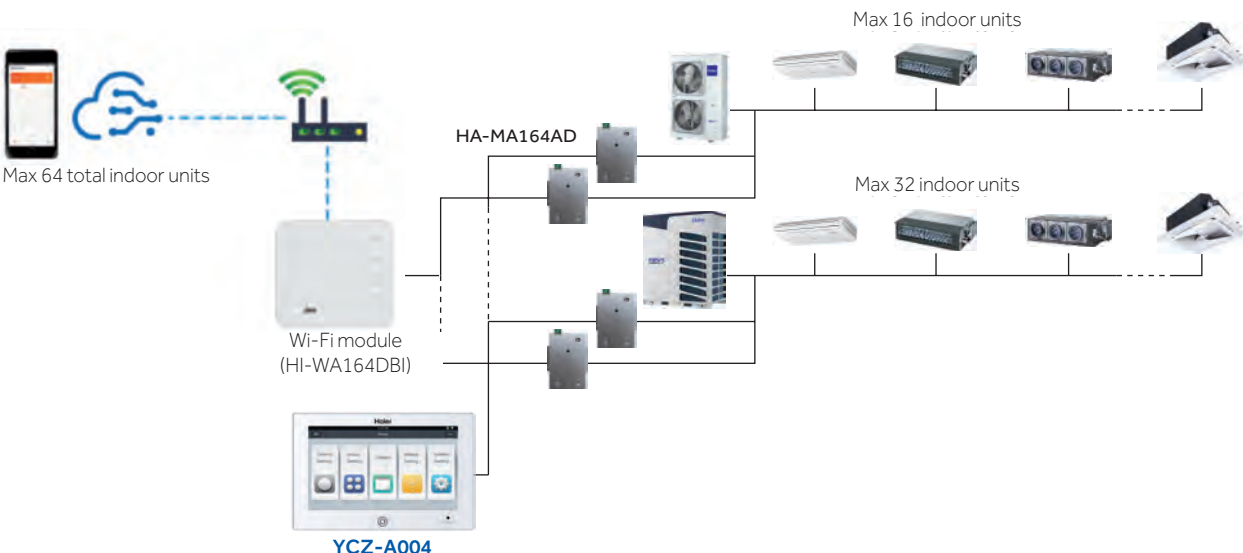

CONNECTION OF CENTRALISED CONTROLLERS DIRECTLY TO OUTDOOR UNITS

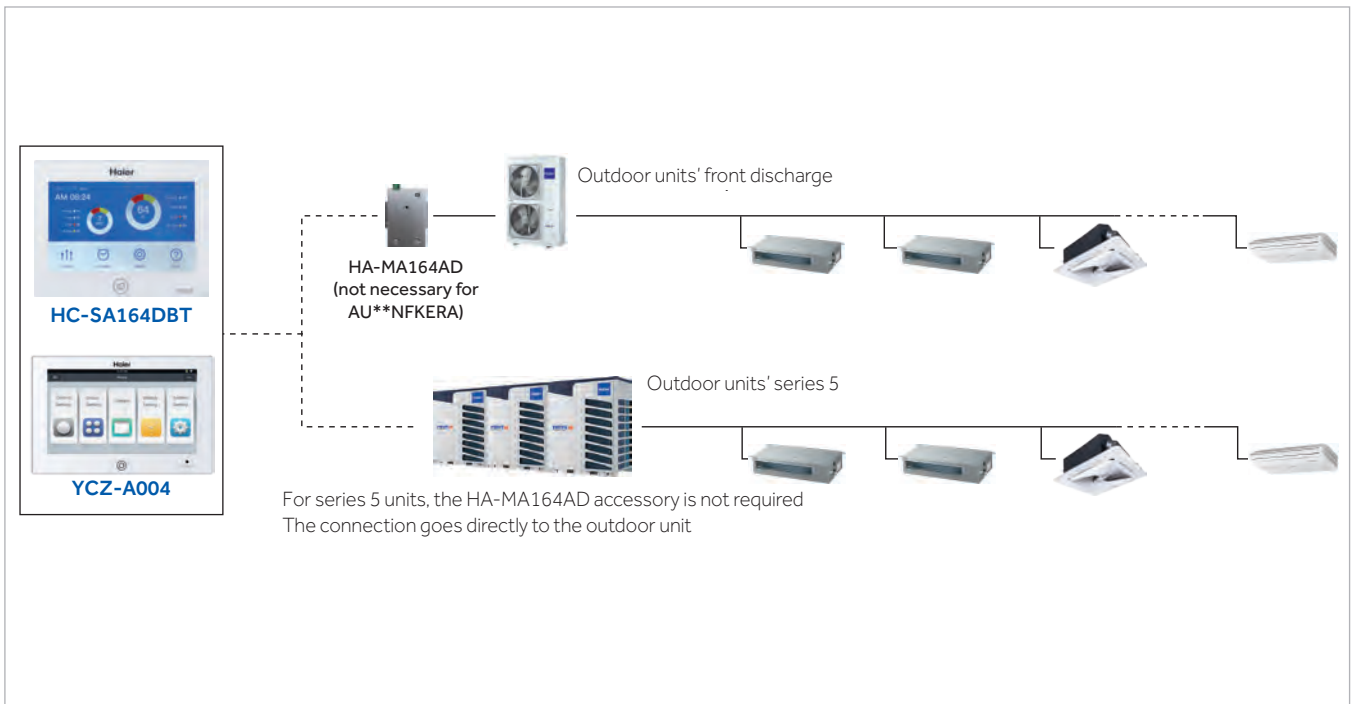

CONNECTION OF CENTRALISED CONTROLLERS IN AN INTERNAL POINT OF THE PLANT
IN THIS CONFIGURATION, THE 5 SERIES UNITS ALSO REQUIRE THE HA-MA164AD ACCESSORY

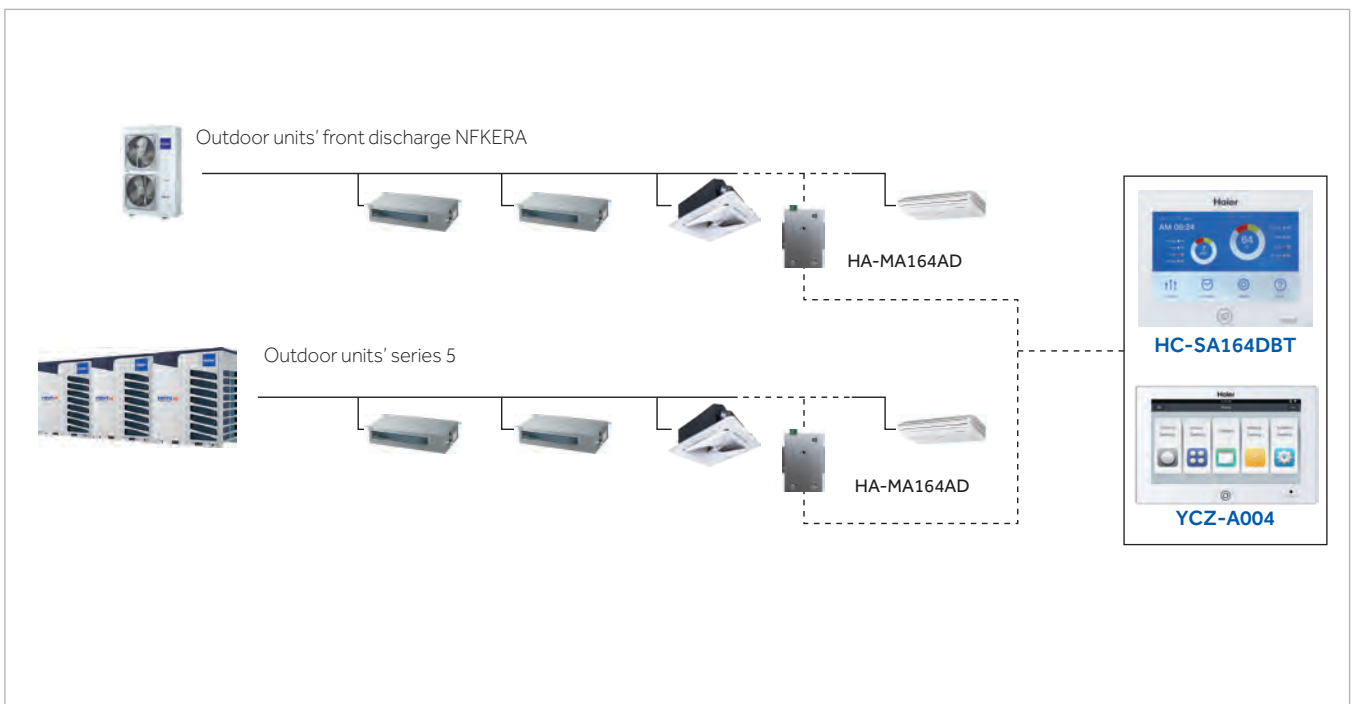

CONNECTION OF CENTRALISED CONTROLLERS IN MIXED MRV AND SUPERMATCH SYSTEMS ONLY FOR HC-SA164DBT

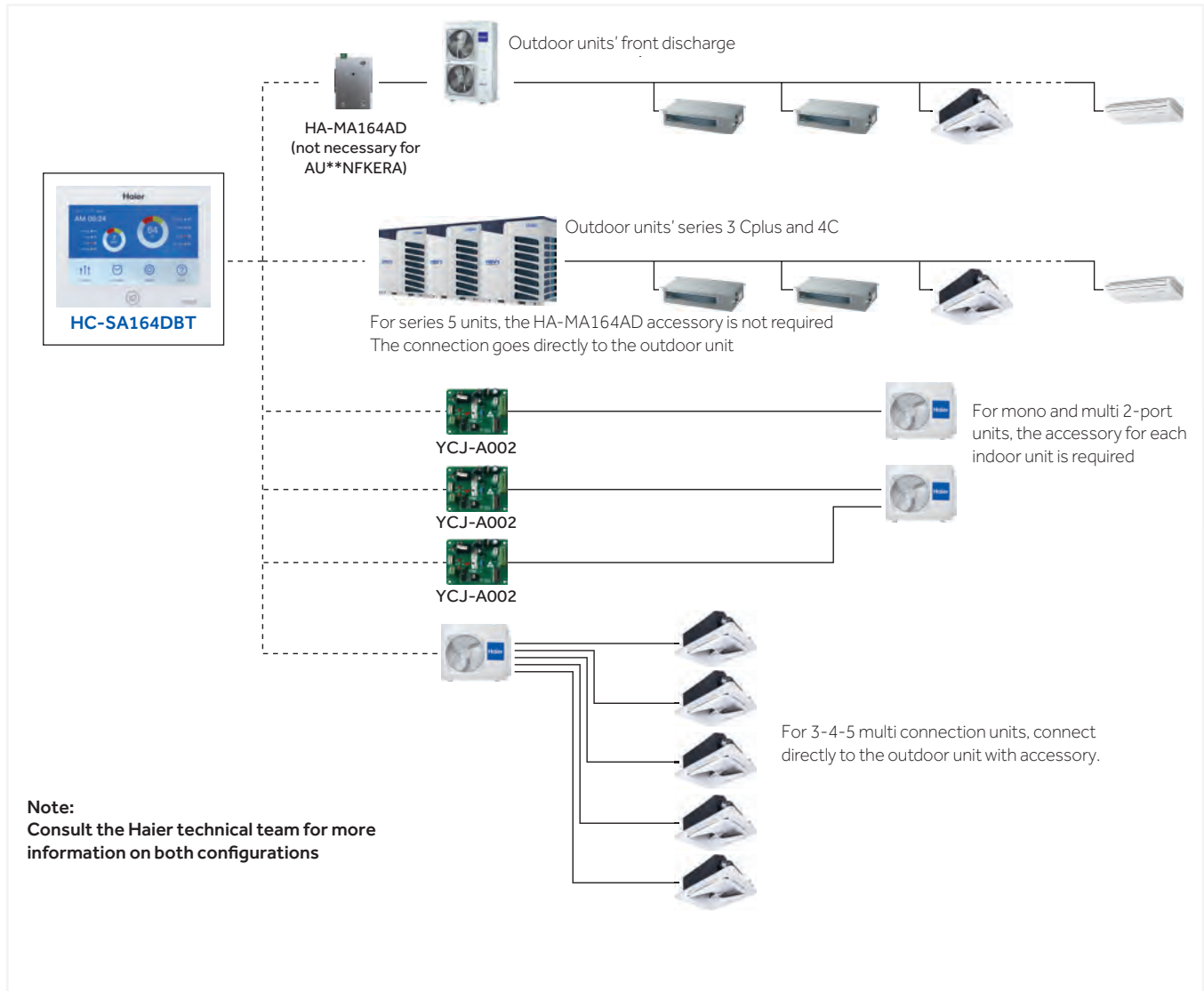

CONNECTION OF CENTRALISED CONTROLLERS TO SYSTEMS COMPOSED ONLY OF SUPERMATCH UNITS

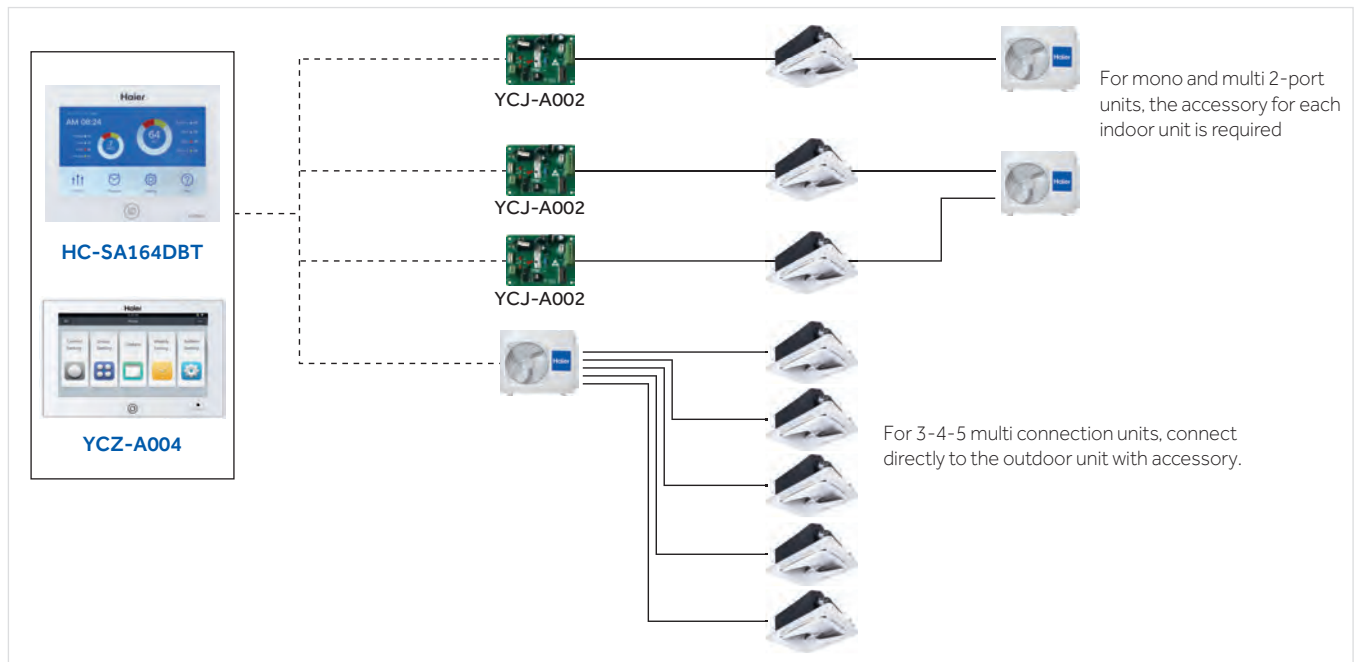

CONNECTION OF THE CENTRALIZED CONTROLLER IN MRV-SUPERMATCH MIXED SYSTEMS ONLY WITH HC-LA1CDBT

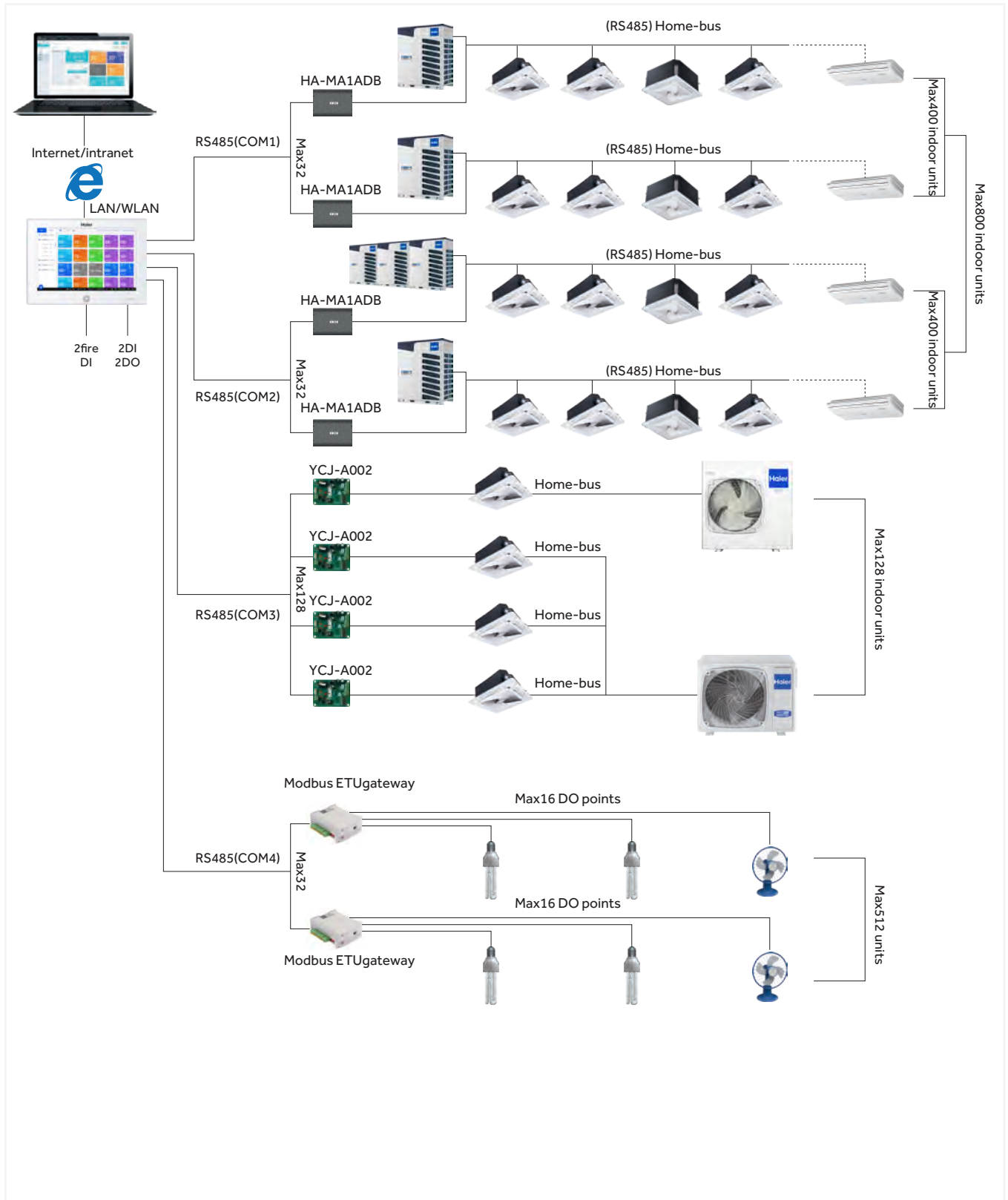

REMOTE CONTROLLERS

Haier offers different types of remote controllers to choose from based on your functional and design requirements.

YR-HQS01 **R32** + **R410A**

- On/Off. Operation Mode. Fan speed. Temperature setting. Swing
- Turbo and Quiet
- Individual louver control for "Round flow cassette and Cassette 620
- Clock & Timer
- Health function
- Self-Clean
- Backlight



HA-SB101DB **R32** + **R410A**

- Infrared signal receiver
- Realize the remote control of duct type indoor unit
- Model selection depends the duct indoor unit

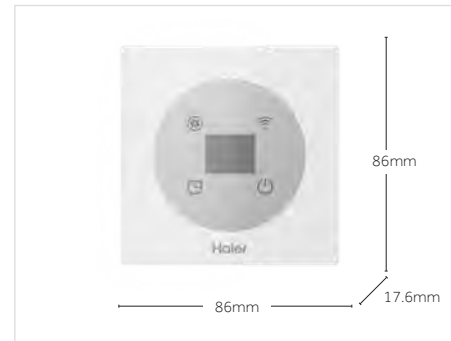

HW-BA101ABT **R410A**

- Modern, high-intensity LED design
- Full touch black display. Automatic lighting when the keys are pressed. Black screen at rest position.
- NOT equipped with a clock or timer
- Double temperature and fan speed setting mode; a continuous infinite range or by acting on the classic + and -
- Quiet operation
- Operating mode, deflectors in on / off mode
- Possibility of group control of up to 16 indoor units with the same operating mode
- Limited features ideal for hotels
- Filter cleaning interval indication
- Error control
- Function block from centraliser

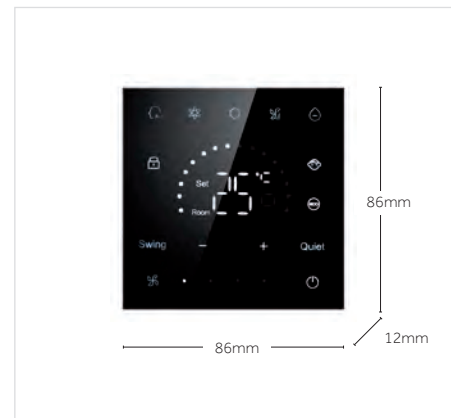

HW-SA201ABK **R410A**

- Modern, high-intensity LED design
- Full touch black display. Automatic lighting when the keys are pressed. Black screen at rest position.
- NOT equipped with a clock or timer
- Double temperature and fan speed setting mode; a continuous infinite range or by acting on the classic + and -
- Quiet operation
- Operating mode, deflectors in on / off mode
- Possibility of group control of up to 16 indoor units with the same operating mode
- Limited features ideal for hotels
- Filter cleaning interval indication
- Error control
- Function block from centraliser



NEW HW-BA316AFK **R32 + R410A**

- Two core non-polarity wiring, installation convenience
- Basic function: on/off, mode, fan speed, temperature setting
- Individual & group control (max. 16 indoor units)
- Built-in infrared signal receiver for infrared remote control
- R32 visual and acoustic leakage alarm

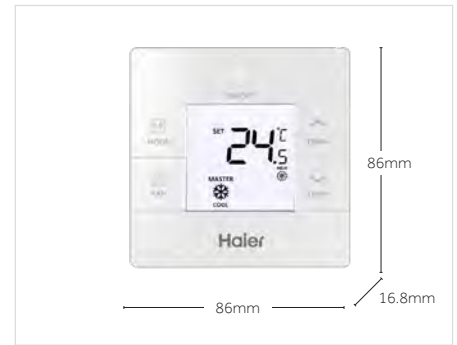

NEW HW-PB101AFK **R32 + R410A**

- Two core non-polarity wiring, installation convenience
- Individual & group control (max. 16 indoor units)
- Basic function: on/off, mode, fan speed, temperature setting
- Built-in infrared signal receiver for infrared remote control
- Built-in buzzer
- R32 visual and acoustic leakage alarm
- IDU & ODU parameters checking



NEW HW-SA301AFK **R32 + R410A**

- Two core non-polarity wiring, installation convenience
- IDU & ODU parameters checking
- Individual & group control (Max. 16 indoor units)
- On/Off, mode, fan speed, temperature, swing
- °C/°F, Temp. adjustment sensitivity $\pm 0.5^{\circ}\text{C} (\pm 1^{\circ}\text{F})$
- Timer
- Backlight off
- Built-in infrared signal receiver for infrared remote control
- Individual louver control for round-way cassette
- R32 visual and acoustic leakage alarm
- Self-cleaning function

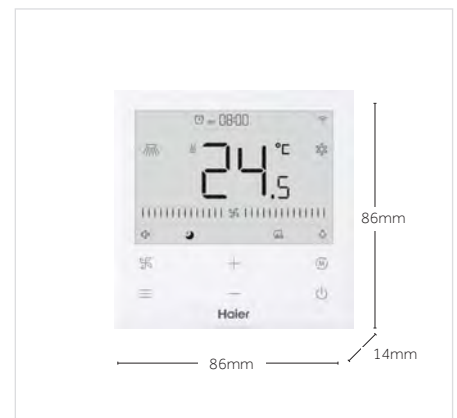

EXAMPLES OF CONNECTION OF REMOTE CONTROLLERS AND WI-FI MODULES

Example of single controller connection for independent operation of each indoor unit



Example of group controller (only for wired controllers - max 16 indoor units on a single controller)

In a group management with a single wired controller, the functions and operating modes of all the internal units connected to that controller will be identical to each other. Independent management is not possible. Each command given will be replicated on all the indoor units in the same way.

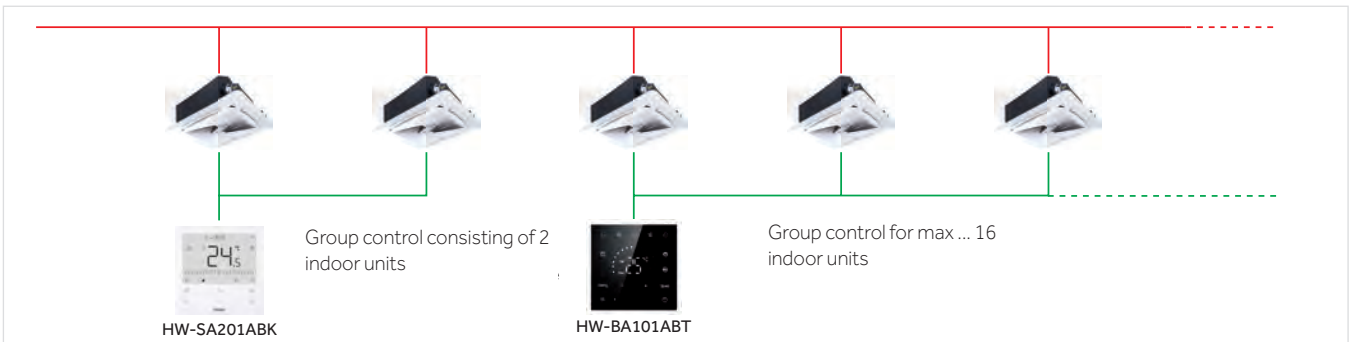

Example of a Wi-Fi module connection, for independent operation of each indoor unit

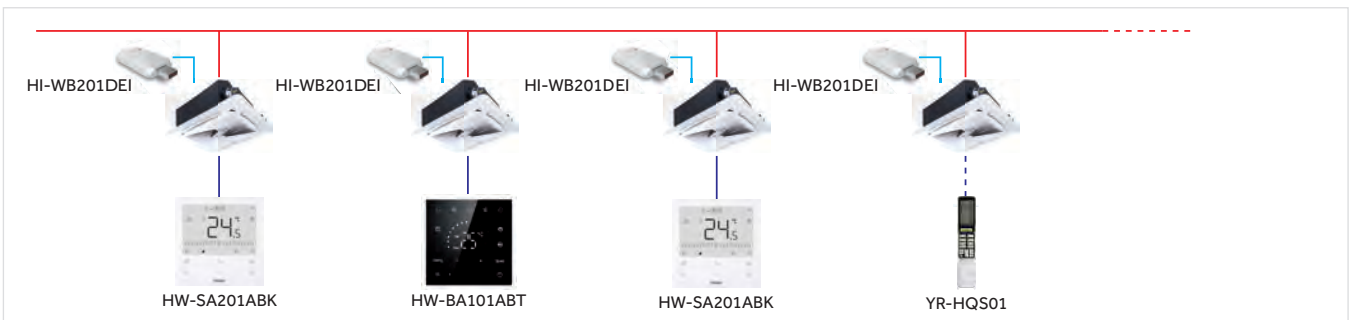

Example of group management through Wi-Fi module

Connect only one Wi-Fi module on the same Master unit, where the group wired controller is connected. Each command given through the APP, as for a group wire controller, will be replicated in the same way on all the indoor units connected to that wi-fi controller / module.

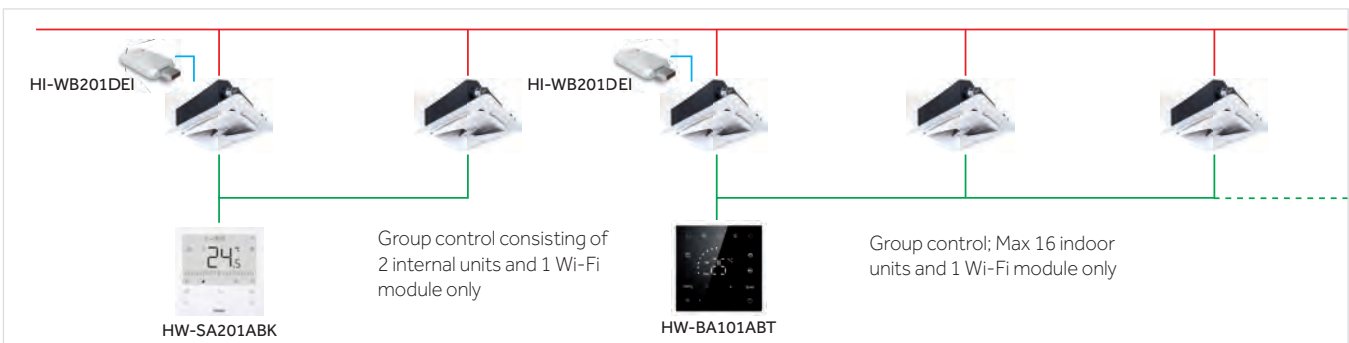

Infrared receiver on controller.

Wired controller models: HW-BA136AFK, HW-SA301AFK and HW-PB101AFK are equipped with receiver for wireless remote controllers. This function allows you to control an indoor unit with the wired controller and with a remote control simultaneously. (example: wired controller on the wall and remote controller on the desk or on the bedside.)



INTEGRATED MANAGEMENT SYSTEM FOR MEDIUM AND LARGE BMS PLANTS



HCM-01A LOCAL MANAGEMENT SYSTEM FOR MEDIUM-SIZED PLANTS

- MRV plant supervision and management system for local use on PC.
- RS-485 protocol converter in RS-232 via USB adapter for local use on PC.
- Control max 400 units and/or maximum 32 independent cooling circuits
- Each cooling circuit requires HA-MA164AD adapter (except for outdoor unit series 5)
- Management of all system parameters by zones / groups / individual units, weekly and monthly timers, error management and alarm history.
- Clear and intuitive visualisation software
- **DOES NOT allow management via web/Internet**
- The software works on Windows platform (7 32/64 bits- 8 Pro - 10 Pro)
- The software has a license for use on a single PC. If you plan to use on two or more PCs, you need to purchase 2 or more licenses
- Possibility of accounting for electricity consumption. Providing IGU-02 adapters instead of HA-MA164AD. One IGU-02 for each cooling circuit, also for series 5 outdoor units. For each cooling circuit / IGU-02, a "Wattmeter / pulse generator" must be provided which detects the energy absorption of the outdoor units and proportionally generates counting pulses that the IGU-02 adapter receives and transforms into values to be managed and visualised by the software **(the pulse generator wattmeter / ammeter is not supplied by Haier, as it must be selected and sized according to the power of the plants).**



INDICATIVE DIAGRAM FOR LOCAL MANAGEMENT WITH HCM-01A

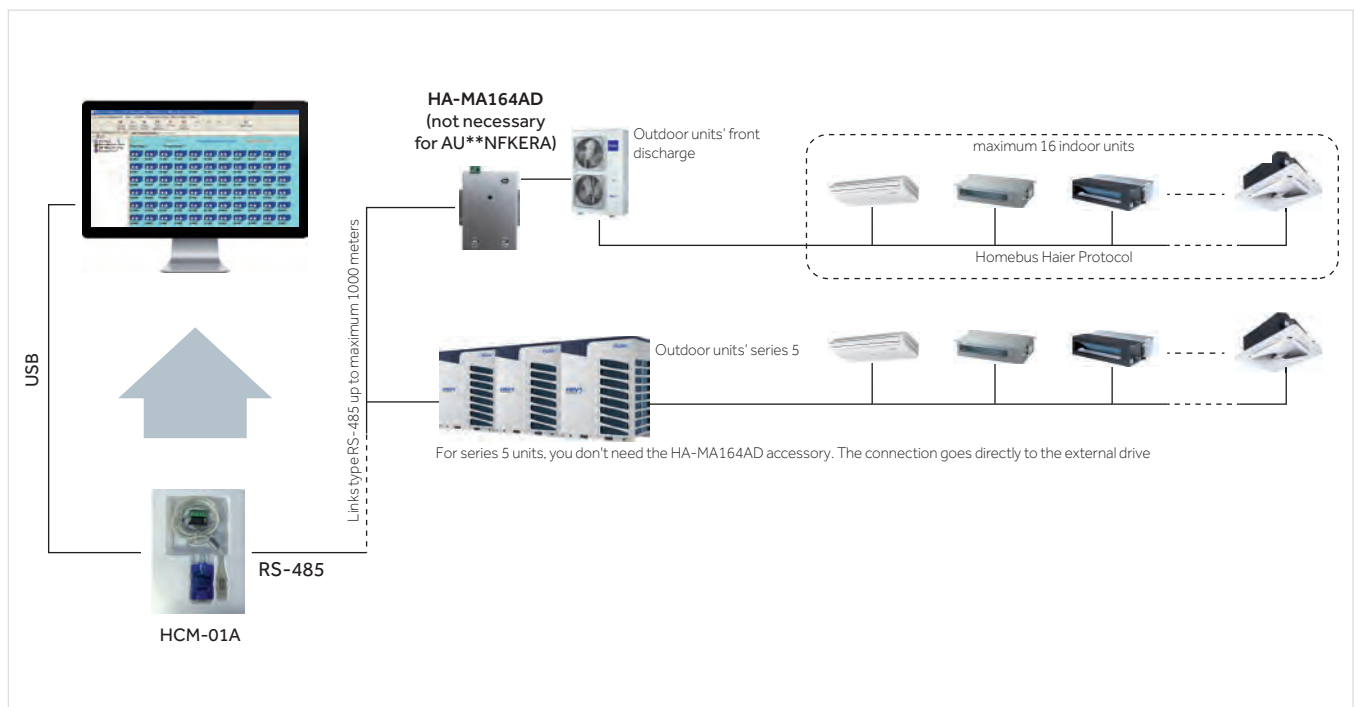

INDICATIVE DIAGRAM FOR LOCAL MANAGEMENT WITH HCM-01A AND CONSUMPTION ACCOUNTING

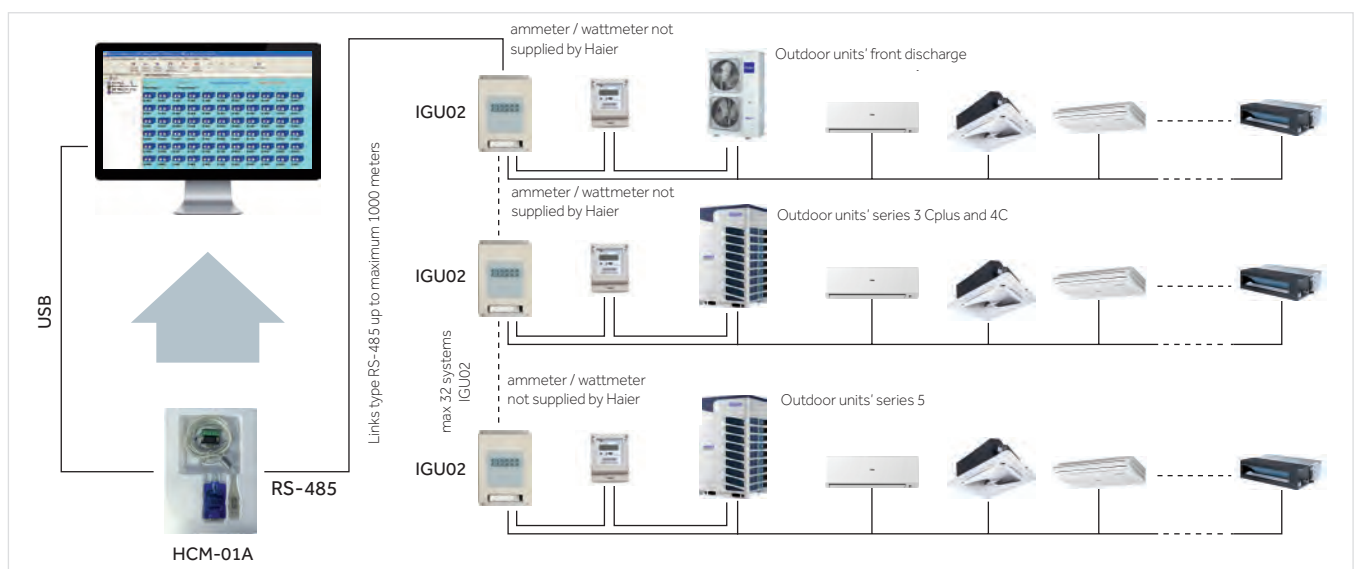

HCM-06B MEDIUM PLANT MANAGEMENT SYSTEM WITH WEB / INTERNET CONTROL FUNCTION INTEGRATED SYSTEM FOR PLANTS UP TO 250 INTERNAL UNITS

- Remote monitoring version
- Third party interface: BACnet ip and Modbus tcp
- Max. 250 indoor units can be controlled for HCM-06B
- Max. 32 systems for HCM-06B. Each system requires one HA-MA1ADB.
- Operation status setting & monitoring
- Schedule setting
- Multi user management with different authorized levels
- Electricity charge report (must use HA-MA1ADB)
- Operation and error history log
- Cooperated technology with honeywell

(the pulse generator wattmeter / ammeter is not supplied by Haier, as it must be selected and sized according to the power of the plants).



ILLUSTRATIVE DIAGRAM FOR MANAGEMENT VIA WEB WITH HCM-06

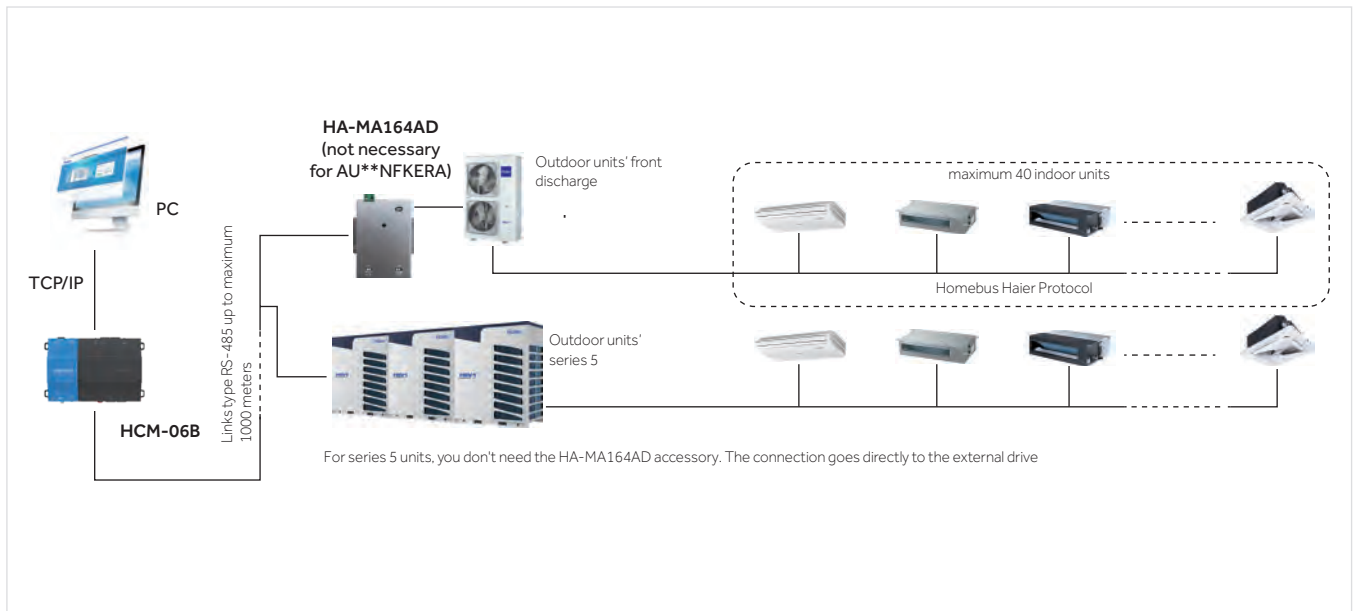

ILLUSTRATIVE DIAGRAM FOR MANAGEMENT VIA WEB WITH HCM-05 WITH CONSUMPTION ACCOUNTING

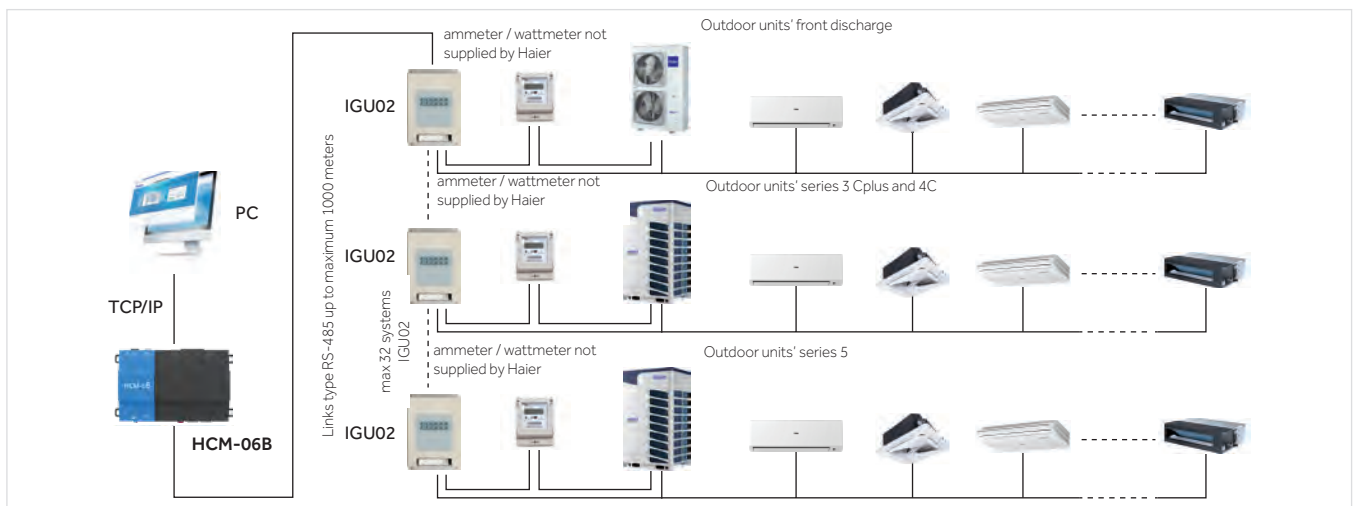



Monitoring

Independent control of up to 500 indoor units

- Mode, temperature, ventilation, defectors
- Blocking of user functions
- Controlling of blocking levels
- An icon with all the information for each individual unit

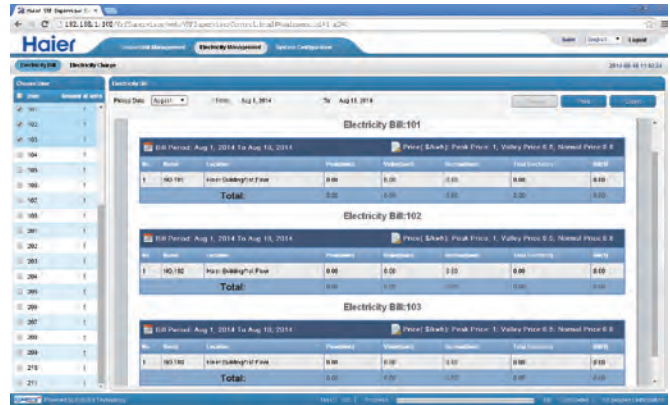

Energy consumption report for each unit

- Data store
- Possibility of defining different costs by usage ranges
- Preview and print the results
- Comparison of operating costs over time

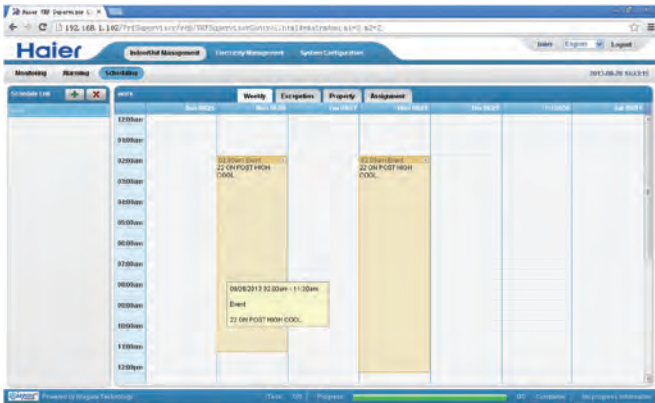

Programming

- Weekly and monthly schedule graph
- Free configuration
- Defining sample programmes

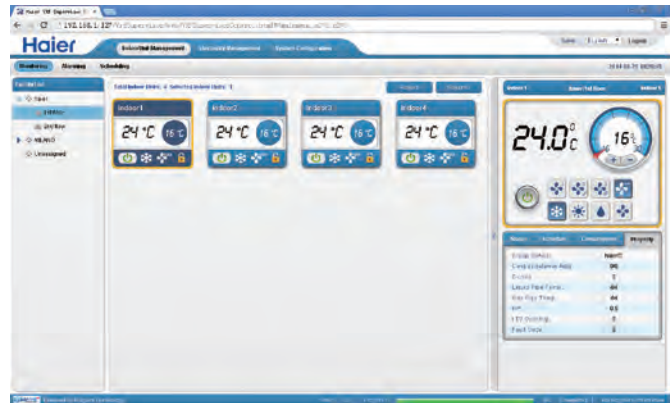

Zone control

- Creation of zones for management that can be customised according to the requests

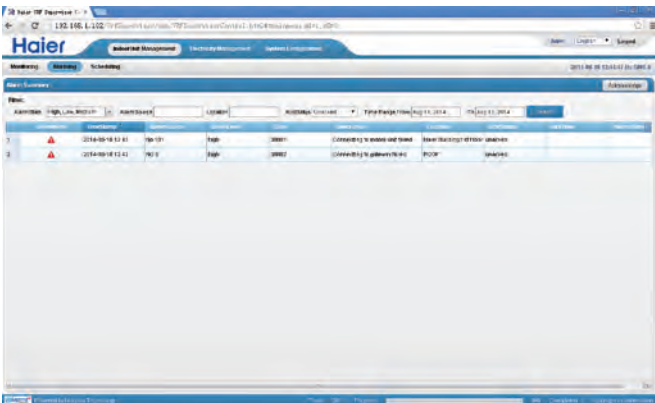

Alarm management

- History of alarm messages
- Detail of every single alarm

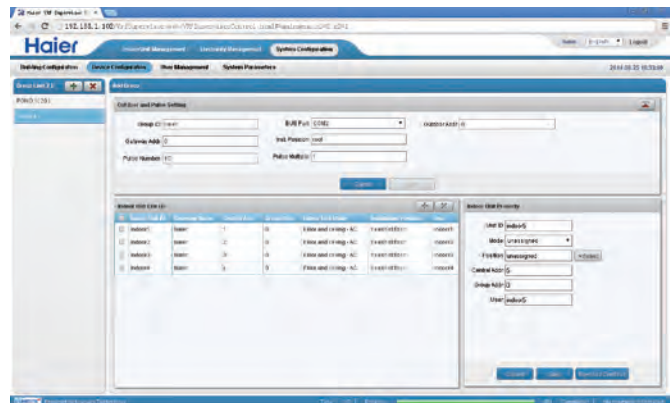

System configuration

- Building-based configuration
- Equipment configuration
- Management of access levels
- Management of parameters

HCM-03A LARGE PLANT MANAGEMENT SYSTEM WITH WEB/INTERNET CONTROL FUNCTION INTEGRATED SYSTEM FOR PLANTS UP TO 1500 INDOOR UNITS

- Local control over the network from PC or remotely via web/internet.
- Each HCM-03A adapter is equipped with a web browser integrated with a specific IP address. Requires a connection to a network with internet access, via ethernet cable. Once configured, anywhere in the world simply enter the IP address supplied with the HCM-03 in the web search engines **Google Chrome or Firefox** to access the system to be controlled. Access to specific system management is protected by multi-level passwords.
- Possibility of communication with systems, not supplied by Haier, through the BACnet - IP, Modbus protocol.
- Max 1500 controllable indoor units.
- Up to 20 independent cooling circuits can be connected to one of the four available ports, in order to obtain a system that provides a maximum of 80 circuits. Each cooling circuit requires HA-MA164AD adapter (except for outdoor unit series 5)
- Management of all system parameters by zones / groups / individual units, weekly and monthly timers, error management and alarm history. Clear and intuitive visualisation software
- Possibility of accounting for electricity consumption. Providing IGU-02 adapters instead of HA-MA164AD. One IGU-02 for each cooling circuit, also for series 5 outdoor units. For each cooling circuit / IGU-02, a "Wattmeter / pulse generator" must be provided which detects the energy absorption of the outdoor units and proportionally generates counting pulses that the IGU-02 adapter receives and transforms into values to be managed and visualised by the software. **(the pulse generator wattmeter / ammeter is not supplied by Haier, as it must be selected and sized according to the power of the plants).**
- Possibility to insert the building layout as a file in the HCM-03A system to create specific command buttons within the reference rooms via the loaded floor plan.
- Technology developed in collaboration with **MAC mini**.



ILLUSTRATIVE DIAGRAM FOR MANAGEMENT VIA WEB WITH HCM-03A.

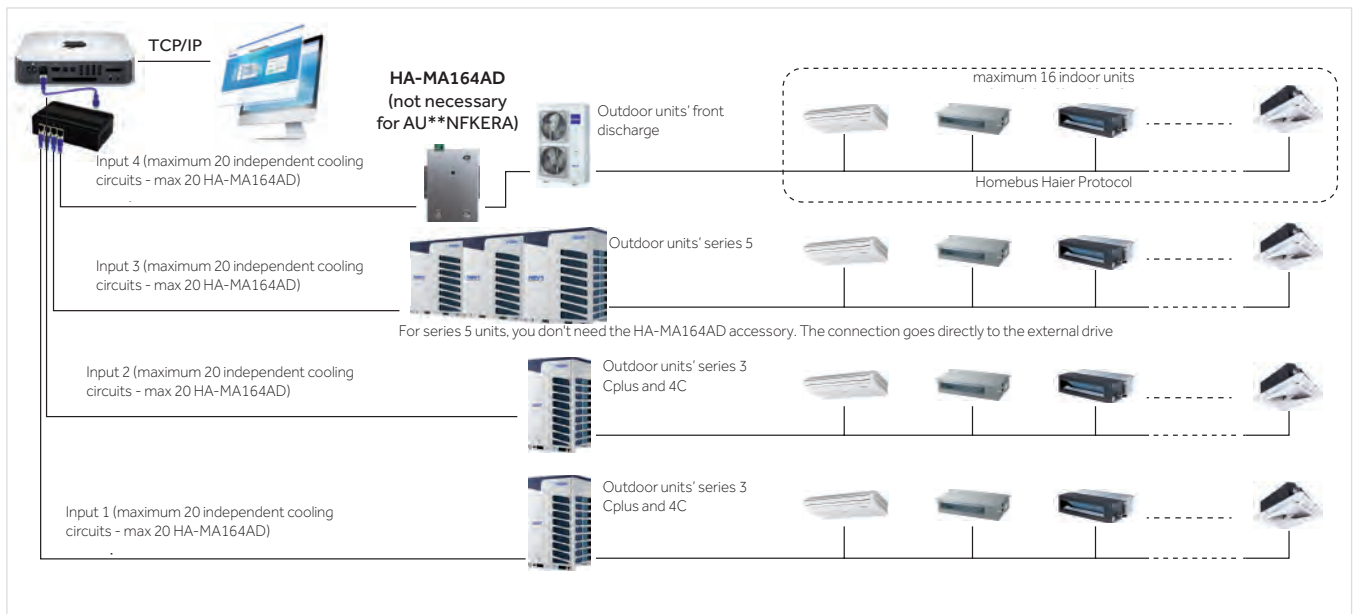

ILLUSTRATIVE DIAGRAM FOR MANAGEMENT VIA WEB WITH HCM-03A WITH CONSUMPTION ACCOUNTING

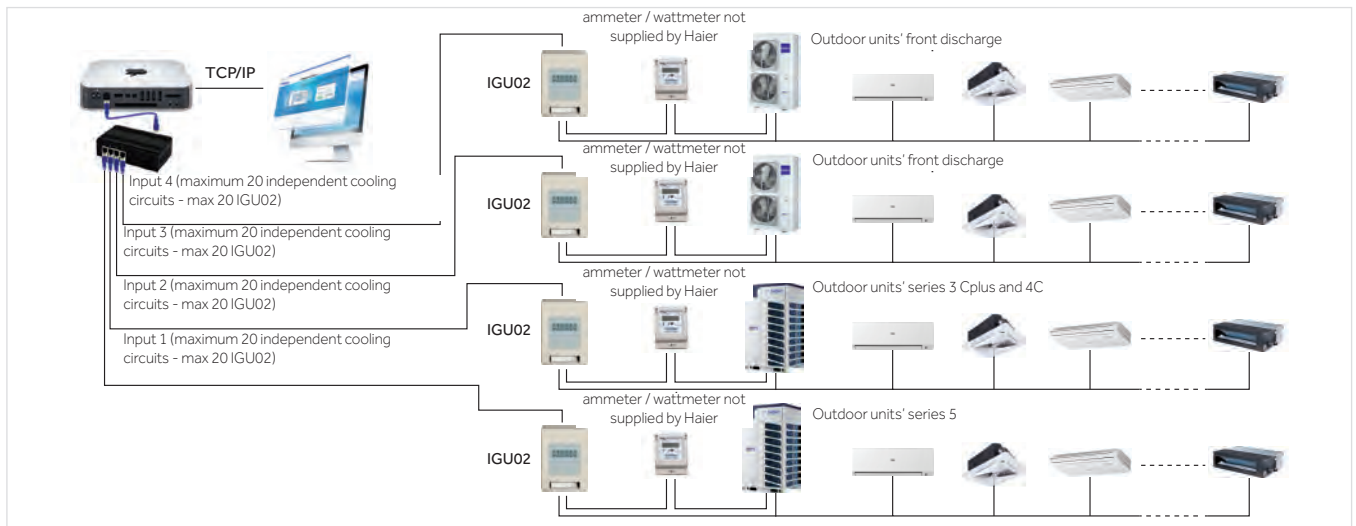

SIMPLE AND INTUITIVE NAVIGATION

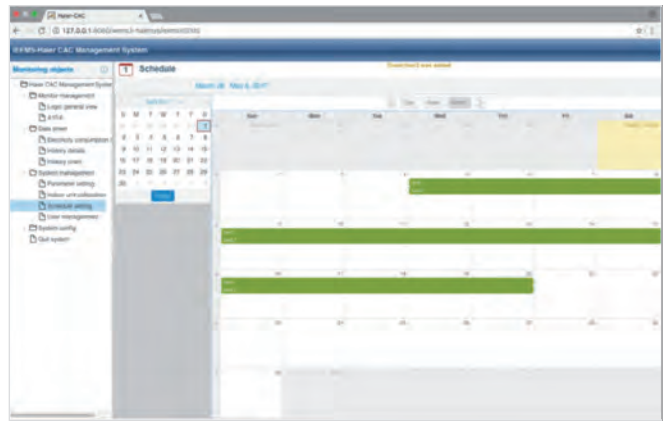
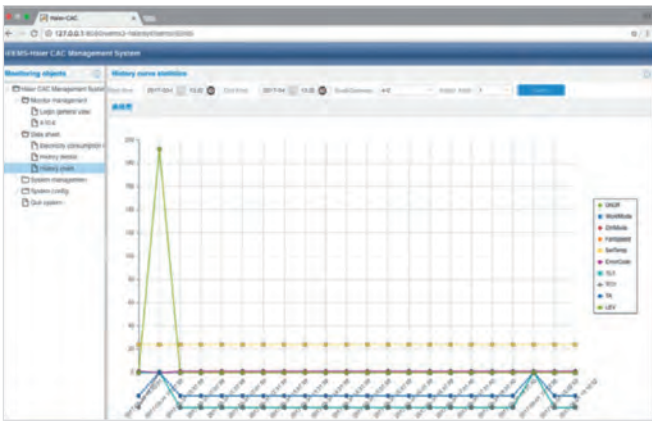
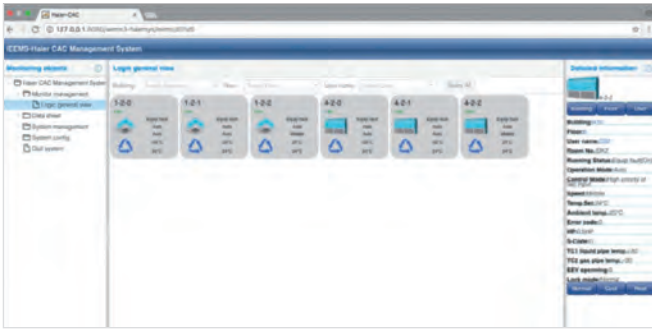

Building layouts can be inserted as a file in the HCM-03A system to configure by positioning the specific indoor unit and the dedicated controller. The creation of specific command buttons inside the premises allows direct management of the floor plan, simulating reality more accurately which makes everything more intuitive and simple.



HA-MA164AD (MODBUS ADAPTER)

- Haier to MODBUS protocol converter (not required for series 5 outdoor units)
- Each cooling circuit requires 1 converter
- 1 converter can handle max 64 indoor units on single cooling circuit
- Power supply transformer included
- It is not possible to account for electricity consumption

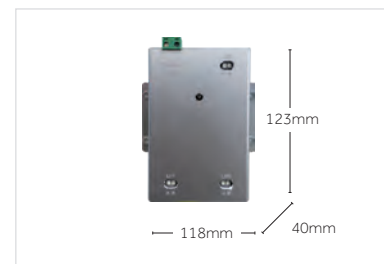

IGU02 (ADAPTOR TO ACCOUNT FOR CONSUMPTION)

- Haier protocol converter to RS-485 to be used in conjunction with BMS systems: HCM-01A / 03A / 05-05A, necessary if you want to monitor the electrical consumption of MRV systems.
- Each IGU-02 can control up to a maximum of 40 indoor units
- You need an IGU-02 for each cooling circuit, even for outdoor 5 series.
For each cooling circuit / IGU-02, a "Wattmeter / pulse generator" must be provided which detects the energy absorption of the outdoor units and proportionally generates counting pulses that the IGU-02 adapter receives and transforms into values to be managed and visualised by the software (**the pulse generator wattmeter / ammeter is not supplied by Haier, as it must be selected and sized according to the power of the plants**).

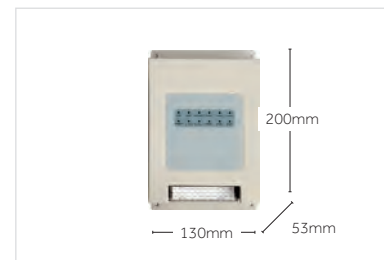

IGU07 (LONWORKS ADAPTER)

- Modbus > Lonworks protocol converter
- Each IGU-07 can control only 1 cooling circuit and up to a maximum of 32 indoor units
- The cooling circuit connected require adapter HA-MA164AD (except for series 5 outdoor units)
- **The IGU07 adapter does not have a power transformer, therefore it is necessary to have a 24 Volt DC power supply (24 VDC) fitted by the installer.**
- It is not possible to account for electricity consumption

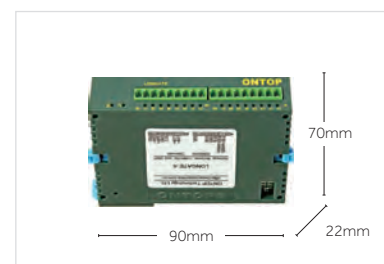

HA-AC-KNX (KNX ADAPTER)

- Haier to KNX protocol converter
- Requires HA-MA164AD adapter
- 3 available models, up to 8, up to 16 and up to 64 controllable indoor units (HA-AC-KNX-8, HA-AC-KNX-16, HA-AC-KNX-64)
- Does not require power supply

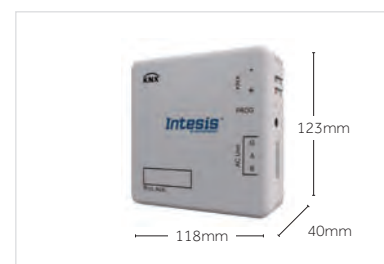

HCM-04

- BACnet gateway, convert modbus rtu to BACnet ip
- Max.128 indoor units/ 4 systems can be controlled. Max. 32 indoor units for one system
- MRV 5 and upgraded MRV SII (8/10/12HP) can connect directly with HCM-04.
- Other MRV systems require IGU02 or HA-MA164AD
- BTL certificate



MTC-001

Application Scenario:

- a. The multi tenant site using separate circuit breaker for each indoor unit
- b. The hotel room using key-tag system which cuts off the power of indoor unit directly
- When it is detected that any connected indoor unit is forcibly cut off, the MTC-001 provides DC power to the indoor PCB to ensure that the indoor unit maintains standby mode: the EEV is turned off and the control signal is blocked to prevent the system from alarming
- Note: If there is power or communication failure in the indoor computer board, MTC-001 cannot be prevented and detected

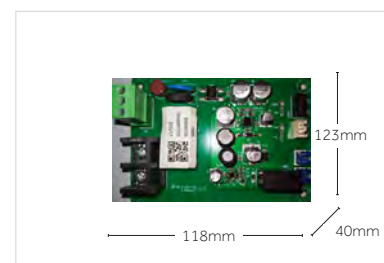

ADDRESS SETTING AND CHECKING TOOL YR-NS

- On/Off, Mode, Fan speed, Temperature setting, Swing
- IDU address checking
- IDU address setting



EXAMPLES OF CONNECTION ADAPTERS

HA-MA164AD, MODBUS ADAPTER

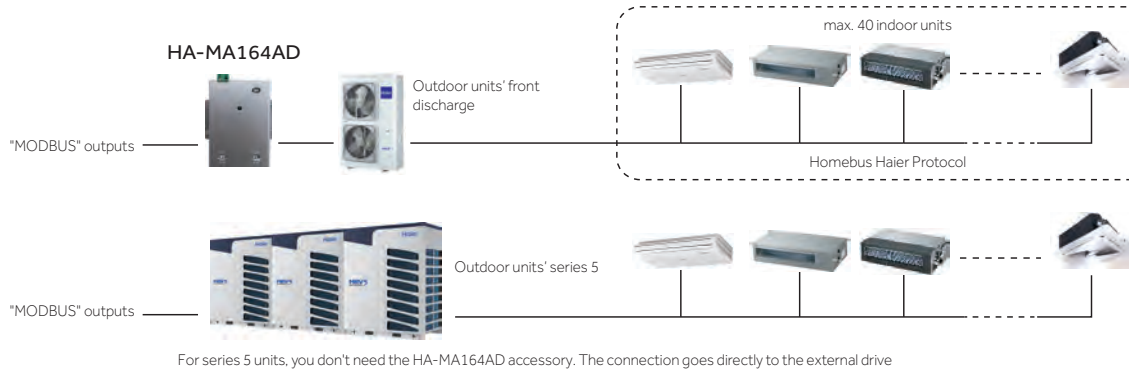

IGU-02 – ADAPTER FOR ACCOUNTING

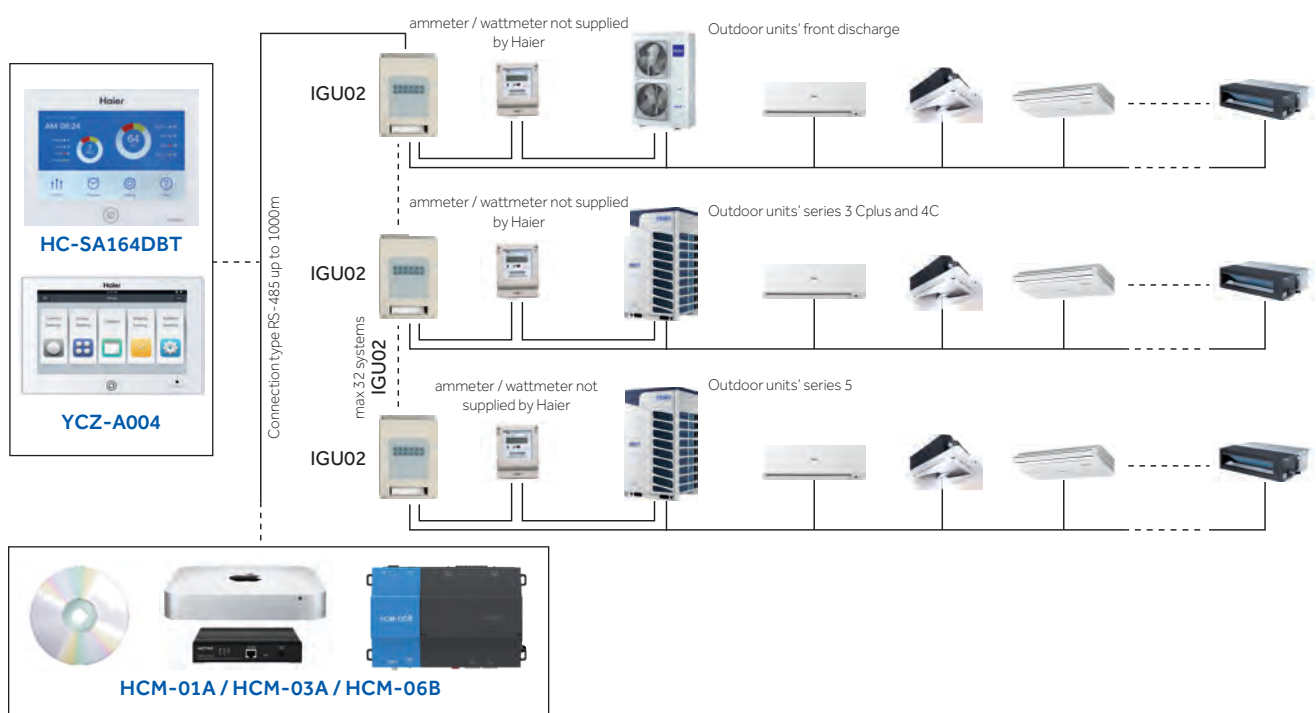

MTC-001

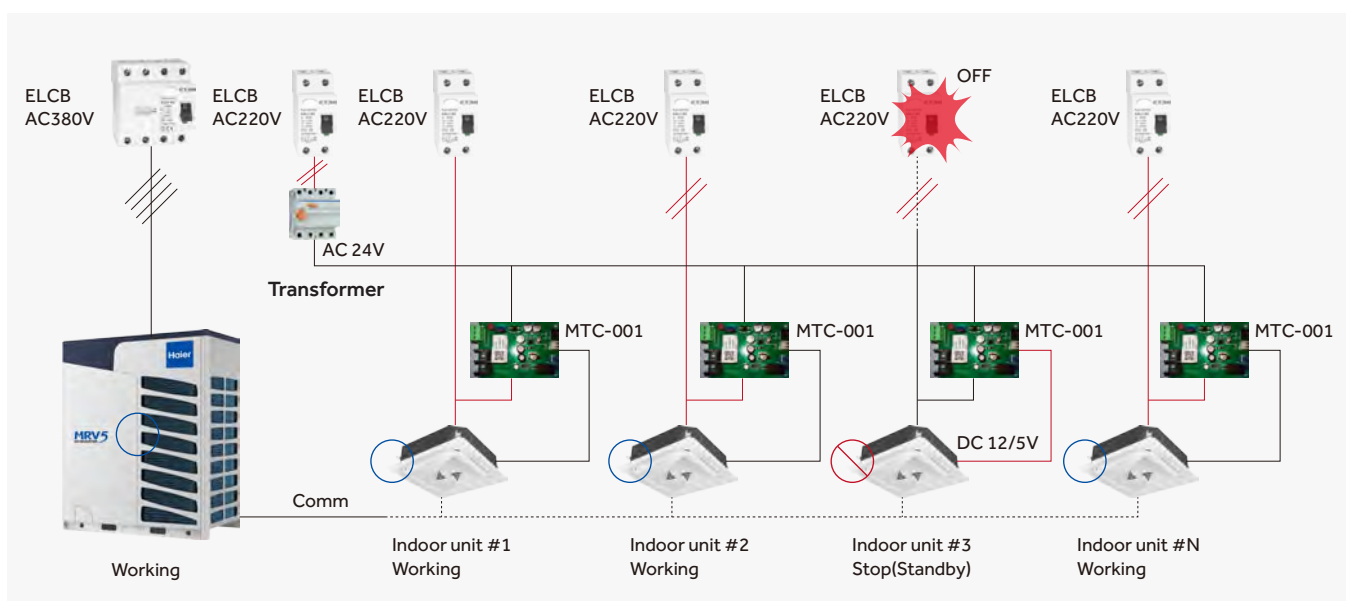

IGU-07 ILLUSTRATIVE CONNECTION SCHEME FOR LONWORKS SYSTEMS

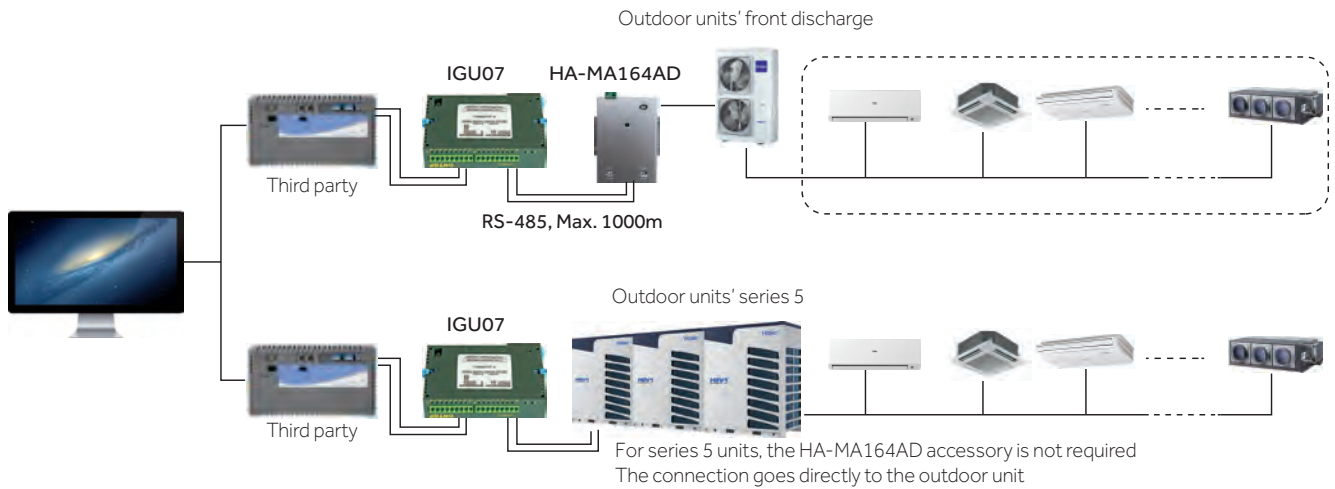

HA-AC-KNX - KNX ADAPTER

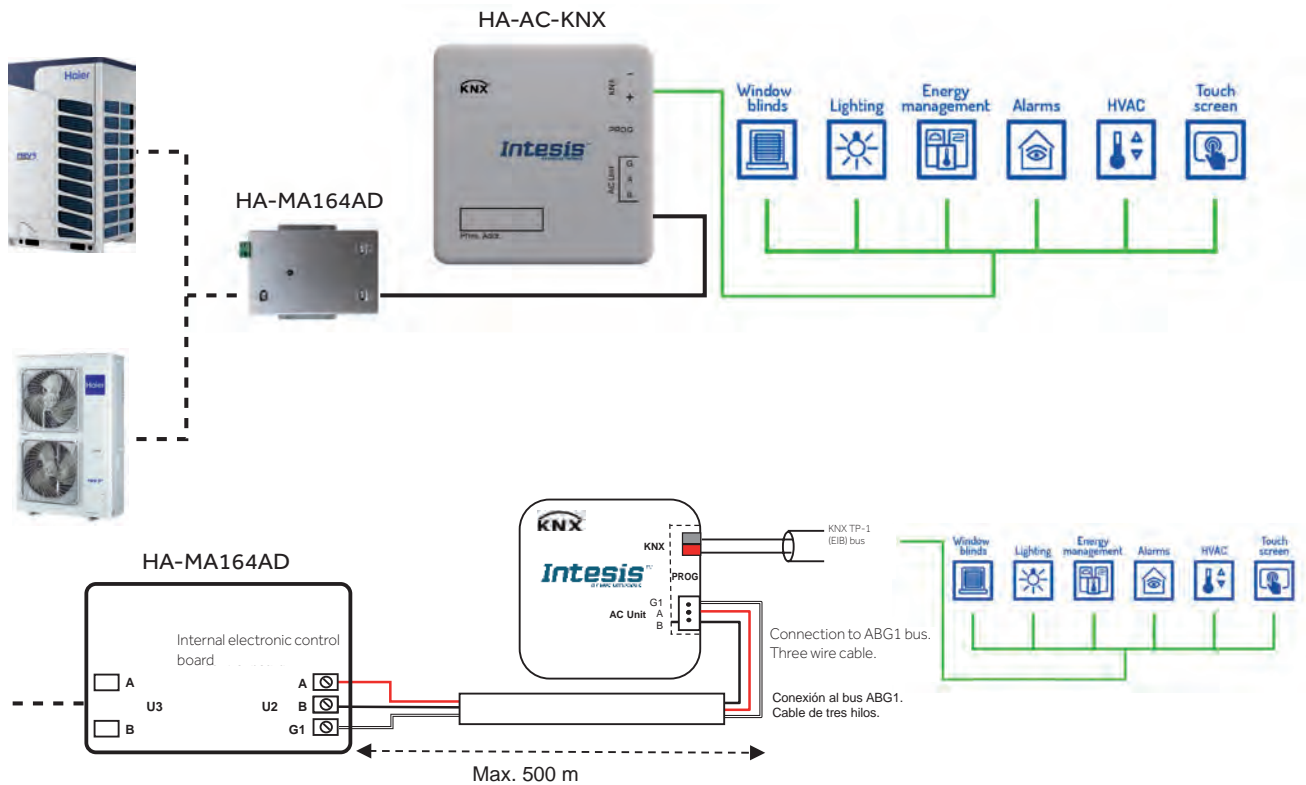



haierhvac.eu

